

# ADVANTAGE

ISSUE 1 | 2019

## SPOTLIGHT ON ELECTRIFICATION



*Volkswagen Motorsport smashed the Pikes Peak International Hill Climb record with an electric car.*

**18**

Electrification of  
Aircraft Propulsion

**24**

Next Generation of  
Electric Vehicle Motors

**32**

Powering Up  
for the Future



# Managed HPC for ANSYS Simulations

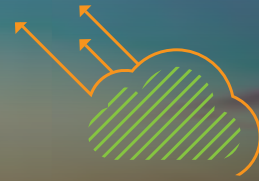

- ✓ Remove the barriers to adopting HPC by having TotalCAE professionals completely manage the TotalCAE HPC cluster appliance in your data center, and in the cloud
- ✓ Simple to use web portal makes it easy to submit HPC jobs to cloud and clusters
- ✓ Speedup your simulations by a factor of 10X to reduce the time to market
- ✓ Access unlimited hardware resources with TotalCAE public cloud
- ✓ Automatic simulation data management
- ✓ License reporting and cloud usage analytics
- ✓ Remote visualization for remote post processing

Hybrid Cloud for Engineers

 TotalCAE

Register today for our report on cloud for ANSYS at <http://www.totalcae.com/ANSYS>

## NEWS, VIEWS, HOW-TO'S

*Keep up with the evolution of simulation.*

*Subscribe to the ANSYS Blog at [ansys.com/blog](http://ansys.com/blog)*

**ANSYS**

# Powering a Revolution



By **Rob Harwood**, Global Industry Director, ANSYS

The increasing electrification of the world around us — from transportation to industrial machines — is changing the nature of energy production, distribution and consumption. And these changes significantly impact traditional product development processes. The use of electronic systems and components can mean a new degree of engineering complexity and introduce design considerations that did not exist before. Yet product development teams still must meet ambitious delivery schedules, aggressive cost targets and stringent regulatory requirements. Given these challenges, engineering simulation is a competitive imperative for those engineering teams participating in the next electrification revolution.

**W**hen you think of product electrification, possibly the first example that comes to mind is the electric car. The majority of the world's leading automakers are already pivoting from the combustion engine to hybrid and fully electric vehicles. But electrification is affecting almost every industry, as product development teams search for new ways to achieve higher levels of performance with improved energy efficiency and reduced environmental impact.

In the aerospace industry, more electric aircraft initiatives drive the replacement of hydraulic and mechanical systems with electric equivalents — and companies envision propulsion systems that are hybrid or fully electric, reducing noise, emissions, weight and fuel burn while improving safety and reliability. In the global energy industry, there is a transition from large centralized power plants to smaller distributed power generation systems and microgrids that are often based on low-carbon or renewable sources of electricity. And, in the face of growing electricity demand, millions of electricity-driven pumps and other industrial machines must become more and more efficient.

There are multiple drivers behind this electrification revolution. As the demand for energy accelerates, the

cost of new enabling technologies is falling — batteries, for example. Geopolitical concerns over energy security — coupled with a growing awareness of the environment and government mandates — encourage investment in local, sustainable sources of electrical energy generation. Electric energy is becoming more trendy and attractive, leading to increased demand from consumers. One thing is certain: Electrification is going to impact your products and many aspects of your business model very soon.

## Meeting the Challenges with Simulation

Adding electrical systems or components to existing systems within products, or replacing traditional technologies entirely, means introducing an incredible new degree of complexity — or completely rethinking the traditional design process.

In a recent survey by ANSYS and SAE, three-quarters of executives confirmed that electrification is driving a fundamental change in their design processes. This will increase the amount of virtual prototyping they perform, which requires a more model-based engineering approach. The executives cited lower development costs, reduced physical testing costs, faster development times, and an increased

level of innovation as their primary reasons for embracing engineering simulation. The majority of those surveyed expect at least a two-times acceleration in their design and development cycle thanks to a simulation-based approach.

This shift is partly because electrical components cannot be studied in isolation. Design of electrified products must incorporate multiple design considerations such as thermal and mechanical robustness, while also considering the performance of the overall system and all its components.

Organizations need to accomplish all this quickly, before competitors master these challenges and seize market share with their own game-changing products. This is why simulation will play such a fundamental role in enabling the electrification revolution.

## The Future Is Electric — and It Begins Now

This issue of *ANSYS Advantage* showcases some of the innovative ways engineering simulation is supporting the electrification revolution. I hope this magazine will help you envision how your company can lead the global drive toward product electrification. ▲

# Table of Contents

## Spotlight on Electrification

### 4

BEST PRACTICES

#### Plugging In to the Potential of Electrification

Engineering simulation is playing a critical role in helping engineers to develop products for electrification.

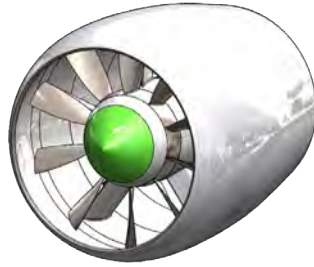

### 10

AUTOMOTIVE

#### Peak Performance for an Electric Vehicle

Using multiphysics simulation, the Volkswagen Motorsport team smashed the Pikes Peak International Hill Climb all-time electric speed record.

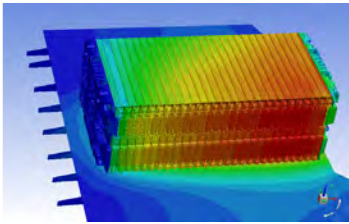

### 14

AUTOMOTIVE

#### Managing Large-Scale Battery Systems

Battery management systems can be made secure and dependable by employing software to simulate the entire closed-loop power system and confirm that all components will work together as designed.

### 18

AEROSPACE & DEFENSE

#### Electrification of Aircraft Propulsion

Developing more electric aircraft requires deployment of engineering simulation to achieve performance goals and reduce the time and costs of testing.

### 21

AUTOMOTIVE

#### The Path of Least Resistance

Fiat Chrysler Automobiles leverages simulation to predict lightning impact on vehicle electronics.

### 24

AUTOMOTIVE

#### Next Generation of Electric Vehicle Motors — The Silent Treatment

When designing a switched reluctance motor, Continuous Solutions used electromagnetic field simulation to reduce torque ripple by 90 percent and total noise by 50 percent.

### 28

ENERGY

#### Electrifying Solutions for Motors and Generators

Marelli Motori meets the demands of the electric power generation market by employing simulation to develop reliable, eco-friendly products at lower cost.

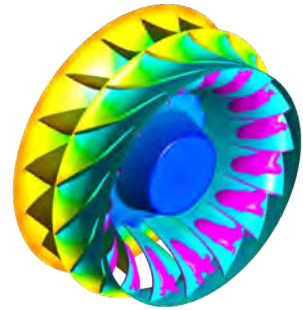

### 32

ENERGY

#### Powering Up for the Future

WEG Energy leverages ANSYS solutions across all aspects of product design, throughout the design process and even during product operation.

#### ABOUT THE COVER

*With the assistance of engineering simulation the Volkswagen Motorsport team smashed not just the electric vehicle record but the all-time record for all cars, in the Pikes Peak International Hill Climb.*

*Learn more on page 10.*

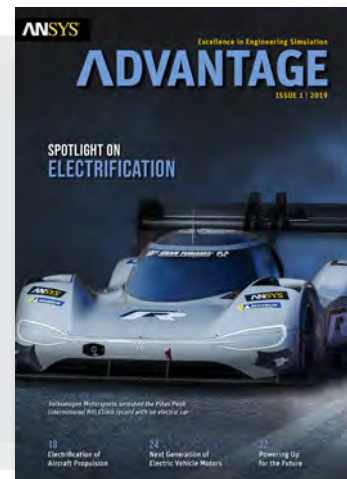



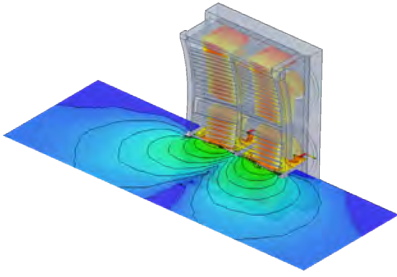

**38**

**ENERGY**

## Protecting Fusion Reactors from Extreme Heat

Simulation helps engineers protect fusion reactor components from operating temperatures of about 150 million degrees.

**42**

**ENERGY**

## Catching the Sun

To avoid damage to solar trackers, engineers use simulation and wind tunnel testing.

**46**

**ENERGY**

## Less Pain to Predict Strain

Cummins developed a new spin on generator set durability modeling by integrating strain correlation models with overall structural analysis.

**50**

**ENERGY**

## Fail-Safe Digital Twin

Engineers use ANSYS software to develop a digital twin of safety relays that will integrate real-time sensor data with simulation results to predict failure.

## SIMULATION@WORK

**54**

**SEMICONDUCTORS**

## Speeding 5G Network Infrastructure Design

Chip-package-system modeling and simulation are vital in designing and verifying products for the 5G market.

## DEPARTMENTS

**58**

**ACADEMIC**

## Framing a Lighter, Stronger Race Car

Additive manufacturing solutions and topology optimization aid a student team to design a lighter and stronger FSAE car that is easier to build.

**61**

**NEWS**

## Simulation in the News

A roundup of news items featuring simulation

## WEB EXCLUSIVES

**ENERGY**

## Fusion Power is the Sun in a Bottle

To help produce fusion power on the same scale as a modern electric power generation station, engineers require simulation.

**ENERGY**

## Reducing Current Stress in Switchgear

A company increased the performance of switchgear designs quickly and economically and delivered superior, reliable energy products to market.

**ENERGY**

## Preserving the Life of Solar Power Inverters

Researchers electronically and thermally characterize solar power inverters before prototyping.

**HEALTHCARE**

## Additive Manufacturing and Simulation Enhance Personalized Implants

Additive manufacturing and simulation help create personalized implants that improve the lives of patients and reduce the overall costs of healthcare.

**THOUGHT LEADER**

## Shifting Left with ANSYS

John Lee of ANSYS and Jacob Avidan of Synopsys share how the ANSYS-Synopsys collaboration helps address the challenges of emerging semiconductor technologies.

Welcome to *ANSYS Advantage!* We hope you enjoy this issue containing articles by ANSYS customers, staff and partners.

**The Editorial Staff, ANSYS Advantage**  
ansys-advantage@ansys.com

**Executive & Managing Editor**  
Chris Reeves

**Editorial Advisers**  
Amy Pietzak, Tom Smithyman

**Editorial Contributor**  
ANSYS Customer Excellence  
North America

**Senior Editor**  
Tim Palucka

**Editors**  
Erik Ferguson      Walter Scott  
Kara Gremillion      Terri Sota  
Mark Ravenstahl      Scott Nyberg

**Art Director**      **Designer**  
Ron Santillo      Dan Hart Design

**ANSYS, Inc.**  
Southpointe  
2600 ANSYS Drive  
Canonsburg, PA  
15317  
USA

Subscribe at [ansys.com/magazine](http://ansys.com/magazine)

### Realize Your Product Promise®

If you've ever seen a rocket launch, flown on an airplane, driven a car, used a computer, touched a mobile device, crossed a bridge, or put on wearable technology, chances are you've used a product where ANSYS software played a critical role in its creation.

ANSYS is the global leader in engineering simulation. We help the world's most innovative companies deliver radically better products to their customers. By offering the best and broadest portfolio of engineering simulation software, we help them solve the most complex design challenges and engineer products limited only by imagination.

Neither ANSYS, Inc. nor Dan Hart Design guarantees or warrants accuracy or completeness of the material contained in this publication.

ACT, Additive Print, Additive Science, Additive Suite, AIM, Aqwa, Autodyn, BladeModeler, CFD, CFD Enterprise, CFD Flo, CFD Premium, CFX, Chemkin-Pro, Cloud Gateway, Customization Suite, DesignerRF, DesignerSI, DesignModeler, DesignSpace, DesignXplorer, Discovery Live, EKM, Electronics Desktop, Elastic Licensing, Enterprise Cloud, Engineering Knowledge Manager, EnSight, Explicit STR, Fatigue, FENSAP-ICE, FENSAP-ICE-TURBO, Fluent, Forte, Full-Wave SPICE, HFSS, High Performance Computing, HPC, HPC Parametric Pack, Icepak, Maxwell, Mechanical, Mechanical Enterprise, Mechanical Premium, Mechanical Pro, Meshing, Multiphysics, Nexxim, Optimetrics, OptiSLang, ParICs, PathFinder, Path FX, Pervasive Engineering Simulation, PExprt, Polyflow, PowerArtist, Q3D Extractor, RedHawk, RedHawk-SC, RedHawk-CTA, Rigid Body Dynamics, RMXprt, SCADE Architect, SCADE Display, SCADE LifeCycle, SCADE Suite, SCADE Test, SeaHawk, SeaScape, SIsolve, Simplorer, Solver on Demand, SpaceClaim, SpaceClaim Direct Modeler, Structural, TGrid, Totem, TPA, TurboGrid, Twin Builder, Workbench, Vista TF, Realize Your Product Promise, Sentinel, Simulation-Driven Product Development

ICEM CFD is a trademark licensed by ANSYS, Inc. LS-DYNA is a registered trademark of Livermore Software Technology Corporation. nCode DesignLife is a trademark of HBM nCode. All other brand, product, service, and feature names or trademarks are the property of their respective owners.

# *Plugging In to the Potential of Electrification*

By **Ahmad Haidari**, Global Industry Director, Energy, ANSYS



Electrification  
[ansys.com/electrification](https://ansys.com/electrification)



Global prosperity requires more electricity from cleaner, more sustainable energy sources. At the same time, the proliferation of electrified systems is changing transportation and industrial processes. With its focus on electric vehicles, the automotive industry has been at the forefront of the media coverage of electrification – however, this trend is now impacting every industry. Engineering simulation is playing a critical role in helping engineers understand and capture the benefits of electrification for their own product designs.

To meet the increasing global demand for energy – while also addressing growing concerns about the environment and energy security – new policy and regulatory measures are combining with technology innovations to spark the next electrification revolution.

The auto industry has established itself as a pioneer, capturing both headlines and consumers' attention by making the move from internal combustion engines to new powertrain designs supporting hybrid and fully electric vehicles. But, now electrification is poised to impact every industry. From the more electric aircraft to industrial equipment and distributed power generation plants, the electrification of traditional product designs is creating a major shift, leading to sustainable R&D investments, as well as product improvements and innovations.

There are several benefits of electrification. Producing electricity from low-carbon sources – including renewables, small-scale nuclear systems, flexible fuels and gas aeroderivatives – enables growing energy demand to be met at a lower cost and with reduced environmental impact. Electrified systems are generally lighter and easier to maintain, while enabling more precise control. They can also be far less expensive. According to Forbes [1], the cost of generating power from offshore wind has fallen by 23 percent since 2010, while the cost of solar photovoltaic electricity has fallen by 73 percent in that time. Likewise, the cost of battery packs, such as those used in electric cars, is continuing to fall.

***“Skyrocketing global demand for energy along with environmental and energy security concerns has sparked the next electrification revolution.”***

However, these benefits are not without challenges. In particular, electrification requires sophisticated new engineering approaches in five key areas related to electrical systems design:

- Power electronics
- Electric machines
- Energy sources such as batteries and fuel cells
- Electromechanical systems integration
- Control software

For each application, the specific engineering problems are different and unique. But electrification teams all share the need to innovate in each of these five areas, quickly and cost-effectively. Companies in every industry feel the pressure to launch groundbreaking new products with electrical components ahead of the competition, and at an attractive price point – and that pressure will only increase.

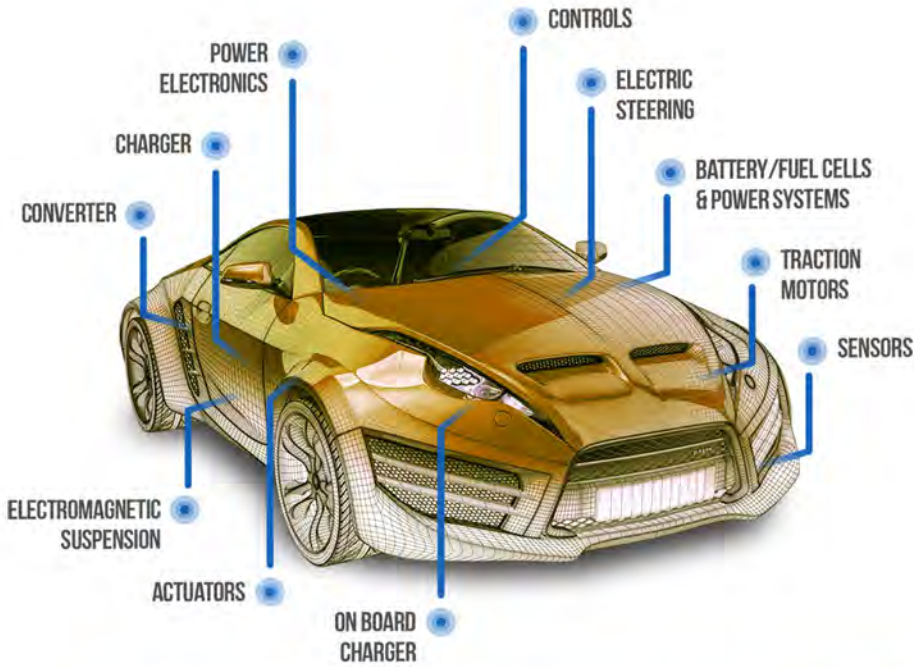

## NEXT GENERATION OF ALL ELECTRIC VEHICLES

Enter engineering simulation, which enables a fast, cost-effective, low-risk solution. By leveraging the powerful capabilities of simulation as a routine part of their product development efforts, engineering organizations can affordably solve even the most complex problems related to electrification — and rapidly launch innovations that position their companies for market leadership.

### WHERE WE ARE TODAY: ELECTRIFICATION AT A GLANCE

While product electrification will influence every industry, several industries are leading the way and making significant progress.

The auto industry’s efforts to develop a broadly adopted electric powertrain design are well-known. Designing a low-cost, lightweight, energy-efficient powertrain system — without sacrificing safety, range, speed, acceleration or passenger comfort — is one of the primary engineering challenges for automakers. Automotive engineers are also investing heavily in new battery and fuel cell designs that exploit novel materials and chemical processes to increase power outputs and storage capacity, while also reducing charging time, size and weight.

In addition to powertrain design, automotive engineers face technical challenges that span the entire vehicle — from heating/cooling and infotainment systems to mission-critical capabilities such as steering and braking. To ensure that all these electrical systems interact seamlessly and safely, engineers must account for every line of control software code and every functional safety system. Only engineering simulation can address multiphysics, multifunctional performance issues quickly enough to meet aggressive development deadlines. Simulation also ensures, from an early design stage, that all components will perform as expected when they are integrated as a complete system.

This issue of *ANSYS Advantage* features several success stories that showcase the contributions of simulation via ANSYS in the global automotive industry. As just one example, ANSYS solutions recently helped Volkswagen Motorsport engineers optimize the battery cooling system for its fully electric race car, leading to a decisive victory — and a new world record for electric vehicle performance — at the 2018 Pikes Peak International Hill Climb (see page 10).

In the aerospace industry, engineers are not only developing technologies that replace existing hydraulic and pneumatic systems with electric equivalents, but



**Electrification: Achieving Next-Level Performance**  
[ansys.com/next-level-electrification](https://ansys.com/next-level-electrification)



also fully electric propulsion systems. This promises to revolutionize the entire design of an aircraft and unleash the promise of urban air mobility — via the introduction of small, regional aircraft capable of making short, affordable flights between cities.

Forget the aircraft as you have always seen it. With electric propulsion, the shape could be completely different. There could be multiple electric motors embedded in the wings; an increased use of lightweight composite materials embedded with antennas and sensors that conduct energy instead of wires; and electric landing and taxiing systems. To make this vision a reality, engineers need to start from scratch and study aerodynamic efficiency, mechanical stresses and electric systems optimization for an entirely new machine design that has never been seen before. They also need to rethink the contribution of control software, which will play a much more significant role in bringing all these systems and components together safely.

Again, simulation provides the means to study all these complex problems and arrive at true innovations. For instance, Seattle-based startup company Zunum Aero was founded to develop an electrically propelled aircraft to connect minor airports using short-haul flights. Simulation enabled Zunum engineers to quickly understand how low-pressure fans, fault-tolerant electric motors and electric controllers work together as a system under real-world conditions. Learn more on page 18.

As electrification proliferates, the global energy generation industry is also being reinvented. The emergence of distributed power generation through variable and renewable energy sources has introduced a new set of challenges in power generation and distribution.

The proliferation of “microgrids” is a chance for engineers to design extremely innovative new systems for local electricity generation from renewable resources, as well as refine the current technologies for storing and distributing this electric energy. One of the central engineering challenges is optimizing the entire power generation and distribution system, including its physical surroundings — because each system’s efficiency depends on the specific weather and geographic conditions around it. In addition to rethinking power generation and distribution grids, there is also a need to modify and optimize components and systems such as wind turbines, turbine blades, converters and generators — as well as downstream equipment such as heat pumps, appliances and industrial machines.

**“Electrification is poised to impact every industry.”**

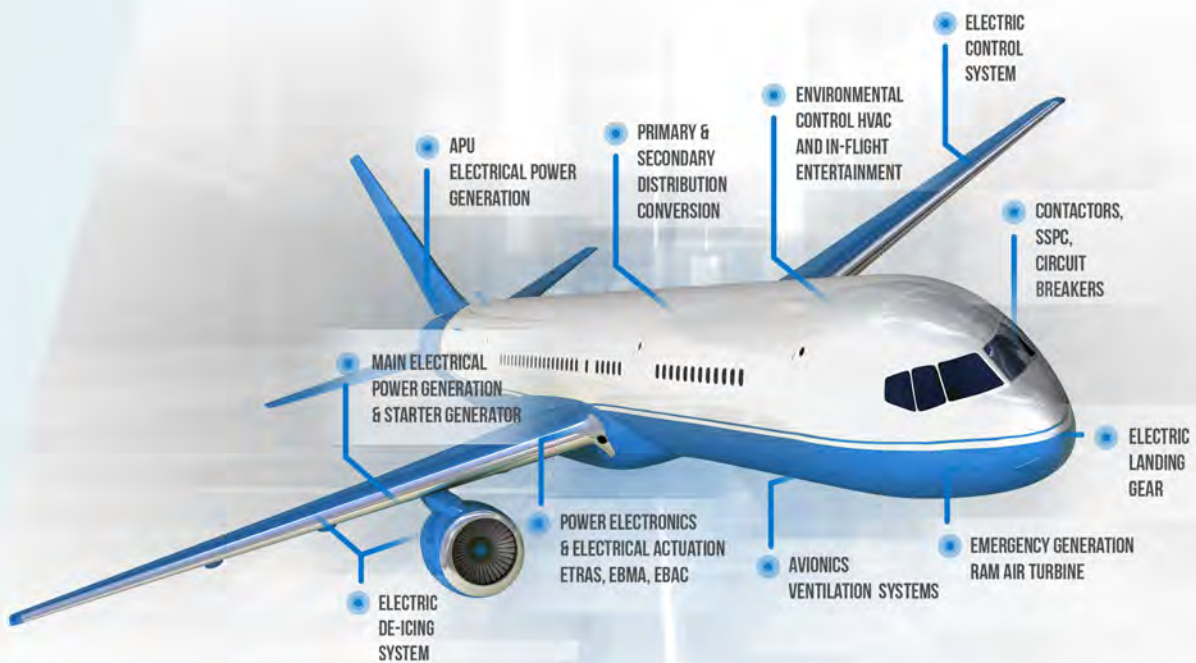

## A NEW GENERATION OF MORE ELECTRIC AIRCRAFT

The article “Preserving the Life of Solar Power Inverters,” a web exclusive, describes how researchers at the University of Pittsburgh are proving the value of simulation to address the engineering challenges related to localized power generation. They leverage capabilities in ANSYS Twin Builder to study temperature dynamics in solar arrays that occur as environmental conditions change, and how these affect the array’s energy outputs. Their goal is to ensure that the product system can maintain consistent performance in the face of inevitable environmental changes.

While often overlooked, industrial systems and machines are an enormous source of worldwide power demand. It has been estimated that industrial electric machines, such as pumps, consume over 40 percent of the global electricity produced today. The designs of these products, established for decades in most cases, are the targets for innovation and improvement. Engineers are coming up with new motor designs, electric drives, power electronics, electromechanical drives, cooling systems, user interfaces and embedded software controls that optimize not only these individual components, but the power consumption and energy efficiency of the entire machine.

**“Engineering simulation has proven that it can play an important role in securing a new energy future via electrification.”**

Brazilian company WEG Energy is a leader in developing wind turbines and generators for power plants. WEG engineers use ANSYS solutions to conduct structural, electromagnetic and thermal simulations of these product systems and their individual components. WEG is poised to revolutionize the global market for industrial machinery. Read the full article on page 32.

#### CHARGING UP ELECTRIFICATION EFFORTS VIA SIMULATION

As electric functionality is added to traditional product designs and as new sources of power become feasible, engineers must solve diverse technical challenges. These include battery management, thermal management, noise reduction, the elimination of electromagnetic interference (EMI), ensuring electromagnetic compatibility (EMC), supporting structural integrity, and minimizing physical damage in real-world operating environments. Engineers must also work to improve performance, increase efficiency, reduce costs and improve safety as they create and investigate entirely new devices, materials and processes for electric machines and power electronics devices.

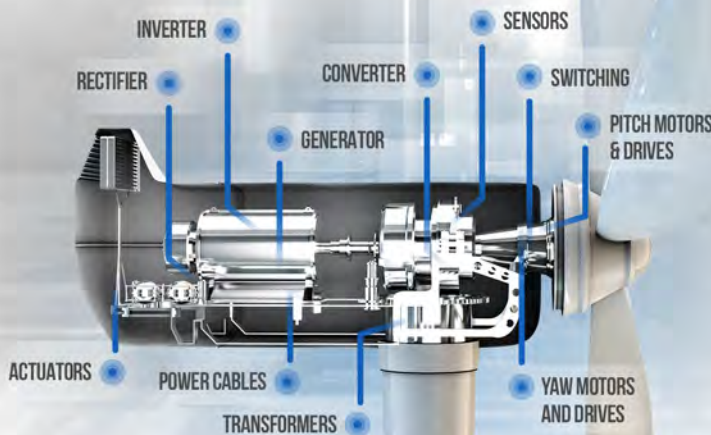

**NEXT GENERATION OF DISTRIBUTED POWER GENERATION**



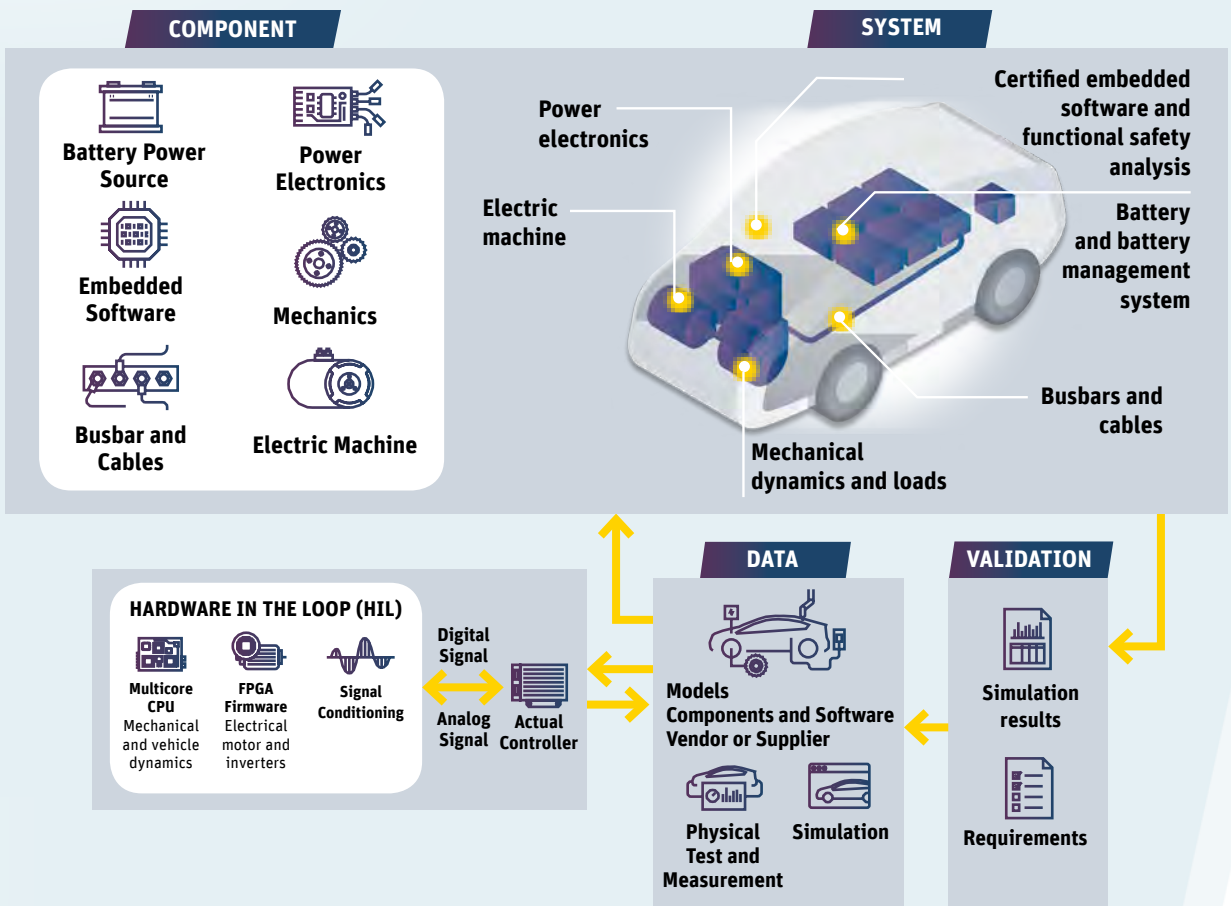

## ANSYS ELECTRIFICATION SIMULATION ENVIRONMENT

Given the breadth, depth and technical sophistication of the electrification-related engineering challenges that span so many industries, engineering simulation makes more sense than ever. Today, simulation solutions are available to address tough engineering problems in the five key areas associated with electrification: power electronics, electric machines, energy sources, electromechanical systems integration and control software.

To support our customers as they explore product electrification, ANSYS offers the flagship software solutions in mechanical, fluids and electromagnetic engineering disciplines needed to conduct multiphysics simulations, supported by capabilities for system-level simulation, functional safety analysis, and embedded software development and verification.

Because of the strength of ANSYS solutions, coupled with decades of experience and support for simulation-driven product development teams, it is not surprising that so many of the world's leading engineering teams rely on simulation via ANSYS to fuel their electrification efforts.

As evidenced in this issue of *ANSYS Advantage*, engineering simulation has already proven that it can play an important role in securing a new energy future via electrification. We hope that the customer successes profiled here will inspire you to consider the possibilities of simulation for electrification in your own business. **A**

*Contributions made by Paolo Colombo, Global Industry Director, Aerospace & Defense, and Sandeep Sovani, Global Industry Director, Automotive, at ANSYS.*

### Reference

[1] Forbes, Renewable Energy Will Be Consistently Cheaper Than Fossil Fuels By 2020, Report Claims, [forbes.com/sites/dominicudley/2018/01/13/renewable-energy-cost-effective-fossil-fuels-2020/#27d6d1eb4ff2](https://forbes.com/sites/dominicudley/2018/01/13/renewable-energy-cost-effective-fossil-fuels-2020/#27d6d1eb4ff2), (12/12/2018)

# PEAK Performance for an Electric Vehicle



By **Benjamin Ahrenholz**  
Head of CAE Department  
Volkswagen Motorsport GmbH  
Hannover, Germany

best, but they had less than a year to produce, test and race an all-new electric car. Using determination, ingenuity and multiphysics simulation, the Volkswagen team smashed not just the electric vehicle record but the all-time record for all cars, including those powered by internal combustion engines.

Developing a vehicle to compete in the Pikes Peak International Hill Climb is a daunting test for engineers around the world. Volkswagen Motorsport engineers were determined to build a car that could compete with the

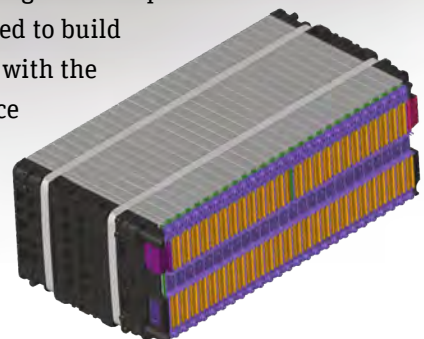

Geometry of a battery module



**“Using ANSYS Twin Builder, Volkswagen Motorsport conducted a six-step multiphysics simulation involving electrical and thermal parameters to design and validate the battery model.”**

If there is one message to take away from Volkswagen Motorsport’s stunning electric vehicle performance in the 2018 Pikes Peak International Hill Climb, it is that things do not always work out as planned. Sometimes they work out better.

The plan — launched only nine months before the 96th running of the renowned race on June 24, 2018 — was to beat the all-time electric vehicle (EV) record this year, and then improve the design and try to break the overall record established by an internal combustion automobile next year. Instead, race car driver Romain Dumas negotiated the 156 sharp bends on the 12.42-mile course in the Volkswagen I.D. R Pikes Peak car in less than 8 minutes at 7:57:148, smashing not only the electric vehicle record by more than a minute but also the overall record by over 16 seconds.

This successful result in such a short development time was due to the hard work of a team of Volkswagen employees across the company, along with some help from ANSYS, who consulted with Volkswagen on the design and validation of the battery pack that powered the car to victory.

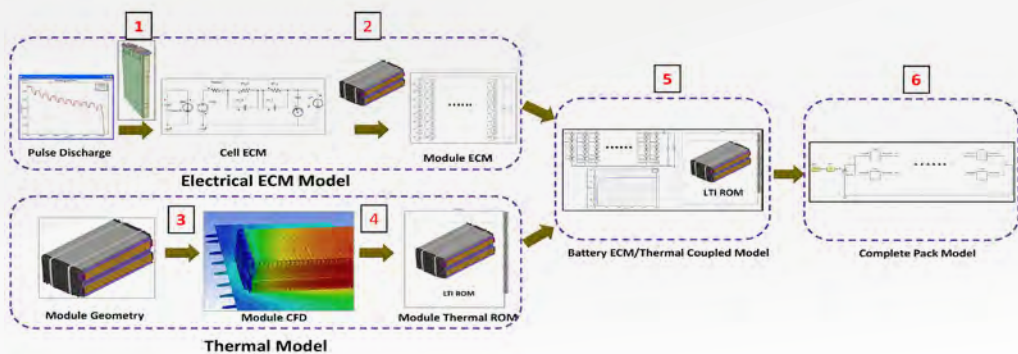

Six-step simulation process schematic

**GOING ELECTRIC**

When Volkswagen decided in 2017 that their long-term strategy would focus on building and selling EVs as passenger cars, they wanted to make a bold demonstration of this commitment — and soon. Not in 2025 or even 2020, but in 2018. Searching for a place to make this statement, they noticed that the 2018 Pikes Peak International Hill Climb, which finishes at an altitude of 14,115 feet, was scheduled for the following June. A tight squeeze. Who could design an electric-powered car from scratch in nine months? The motorsports team is used to changing car designs from week to week, so the task fell to Volkswagen Motorsport.

By deciding to employ an existing race car monocoque, the Norma M20 created by Norma Auto Concept in France, the team eliminated the need to design the body of the car. But the monocoque, which typically houses an internal combustion engine, had limited space available for batteries, even when the engine was removed. And Volkswagen Motorsport had little experience designing batteries. When the ANSYS team offered to help design and validate the battery modules using simulation, Volkswagen accepted.

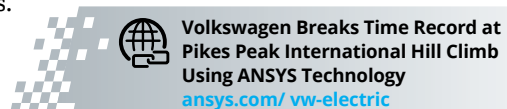

“The Volkswagen team *smashed* not just the electric vehicle record but the *all-time record* for all cars, including those powered by *internal combustion engines*.”



### THE CHALLENGES OF BATTERY DESIGN

Primarily, the battery modules had to store enough energy to reach the peak speed that Dumas would need to drive on the course's straightaways, while ensuring that there would still be energy left at the end of the race. Running out of power short of the finish line would not do. Solving this challenge involved issues of cell selection, sizing of the battery pack, cooling of the pack and charging efficiency, among others.

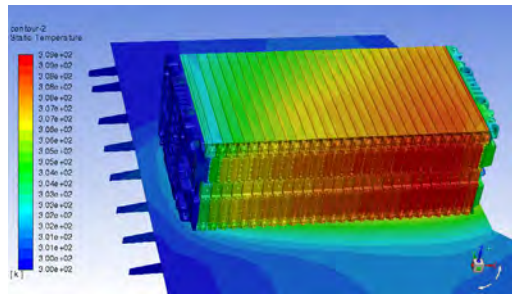

Thermal simulation of a battery module

Optimizing these parameters was key to success. The battery packs had to fit the space available in the chassis while providing sufficient power. Adding more battery modules than necessary would increase the vehicle's weight and slow it down. Battery temperature would affect the amount of energy available — the state of charge (SoC) — so determining if air cooling, water cooling or no cooling at all was needed was important. Charging efficiency was critical because the rules of the race stated that if a run was interrupted for any reason, such as wildlife crossing the road, the team had to start over and be ready to go again in 20 minutes.

### A SIX-STEP SIMULATION APPROACH

Using ANSYS Twin Builder, the Volkswagen Motorsport and ANSYS teams conducted a six-step multiphysics simulation involving electrical and thermal parameters to design and validate the battery model. The first step was to develop an equivalent circuit model (ECM) for a single battery cell. The ECM simplifies a complex circuit to aid analysis.

Engineers used test data from a pulse discharge to get all the parameters needed to calibrate the ECM. The first step was done on a single cell to verify that the cell model was created correctly. If anything was wrong, the validation would have revealed the problem. Engineers concluded from step 1 that the ECM is a function of SoC and temperature. The Twin Builder simulation of the ECM was super-fast, requiring only seconds to simulate one full drive cycle of the race car through the entire race course.

Step 2 combined all the ECM cells serially to form an ECM module.

Step 3 involved computational fluid dynamics (CFD) simulation of the thermal properties of a battery module using ANSYS Fluent. Running a CFD simulation was necessary because the electrical performance of a battery is a function of temperature, and a thermal model is needed along with the ECM to predict battery temperature.

The simulation model for a full CFD analysis of a battery model is typically extremely large. In this case, after importing the geometry of the proposed battery module and housing and performing the meshing process, the engineers had a mesh containing 67 million cells. With so many calculations to perform, it took approximately 48 hours using 100 CPUs to run a thermal simulation of one full drive cycle.



This presented a new challenge because, eventually, the ECM and the thermal model would have to be run together in a two-way coupled multiphysics simulation, the discrepancy between the few seconds it took to run the ECM simulation on one CPU and the 48 hours to run the thermal simulation on 100 CPUs made it impossible to couple these simulations.

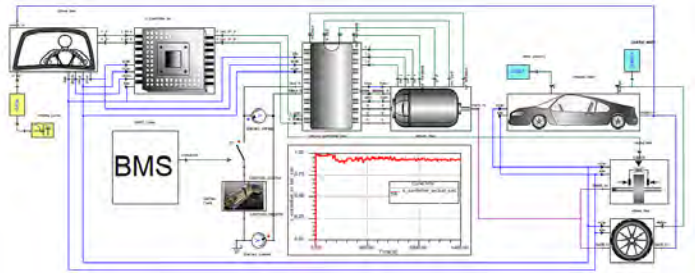

**Battery integration into a vehicle using ANSYS Twin Builder**

The solution came in step 4. Using Fluent, the engineers extracted key thermal characteristics of the system to create a reduced order model (ROM) for the thermal simulation. The ROM is linear and time invariant (LTI), and orders of magnitude smaller than the full CFD model. It yields results that correlate well with the full CFD model, but it runs 10,000 times faster.

In step 5, the ECM and the thermal LTI ROM models were used together to run a two-way coupled multiphysics simulation in Twin Builder. The ECM predicts the electrical performance and how much heat is created. The LTI ROM thermal model takes this heat generation value and predicts temperature, then the temperature is transferred back to the ECM model to determine its effect on electrical performance. This cyclical iteration process continues until the simulation converges on a solution.

Step 6 involves putting the individual battery modules into the full 10-module battery pack that will power the whole EV. Volkswagen used a third-party simulation tool for this final system-level step. The complete battery model predicts the voltage and current relationship to ensure that the battery has sufficient energy for the task at hand — in this case, enough charge to finish the race. It also helps to predict the peak power output of the battery system, and therefore the top speed that the race car can go.

It also predicts battery temperature, making sure the peak temperature is not exceeding the limit.

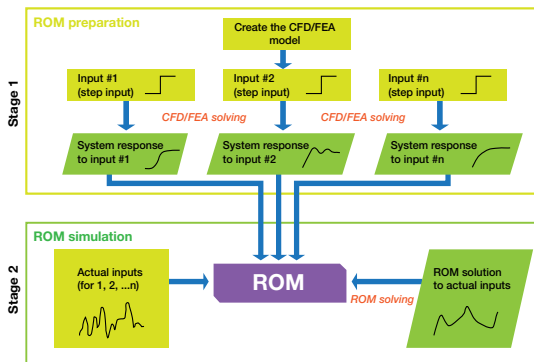

**Battery thermal LTI ROM extraction**

The result of the complete simulation process was to give Volkswagen Motorsport engineers confidence that the battery pack had enough charge to get them to the finish line, and that thermal properties were not a concern in this short race. Solving the battery challenge virtually through simulation instead of building a series of physical prototypes helped them accomplish their goal in the short time frame they were given.

Watching a live stream of the race from their offices in Hannover, the Volkswagen team cheered Dumas and the I.D. R Pikes Peak race car as they climbed the mountain, and they erupted in celebration when the car crossed the finish line in record time. But some of them were not entirely surprised by the result. From practice runs in a driving simulator, the mean time for finishing the race was around 7:57, with a possible faster finish if everything went perfectly and a slower one if they ran into difficulties. Dumas brought the car home in 7:57 — right on the button.

Watching a live stream of the race from their offices in Hannover, the Volkswagen

## LOOKING AHEAD

Having accomplished two years' worth of goals in the first year, Volkswagen was momentarily at a loss as to how to proceed — a great problem for an engineer to have. Should they go back to Pikes Peak to try to improve on their record next year, try to break the record in another race, or switch their focus to the consumer line of I.D. cars that they hope to be selling to the public within a few years?

Whatever they decide, ANSYS engineers are happy to have played a role in Volkswagen Motorsport's outstanding 2018 Pikes Peak victory, and stand ready with their suite of ANSYS simulation solutions to help them solve the challenges ahead. ⚠️



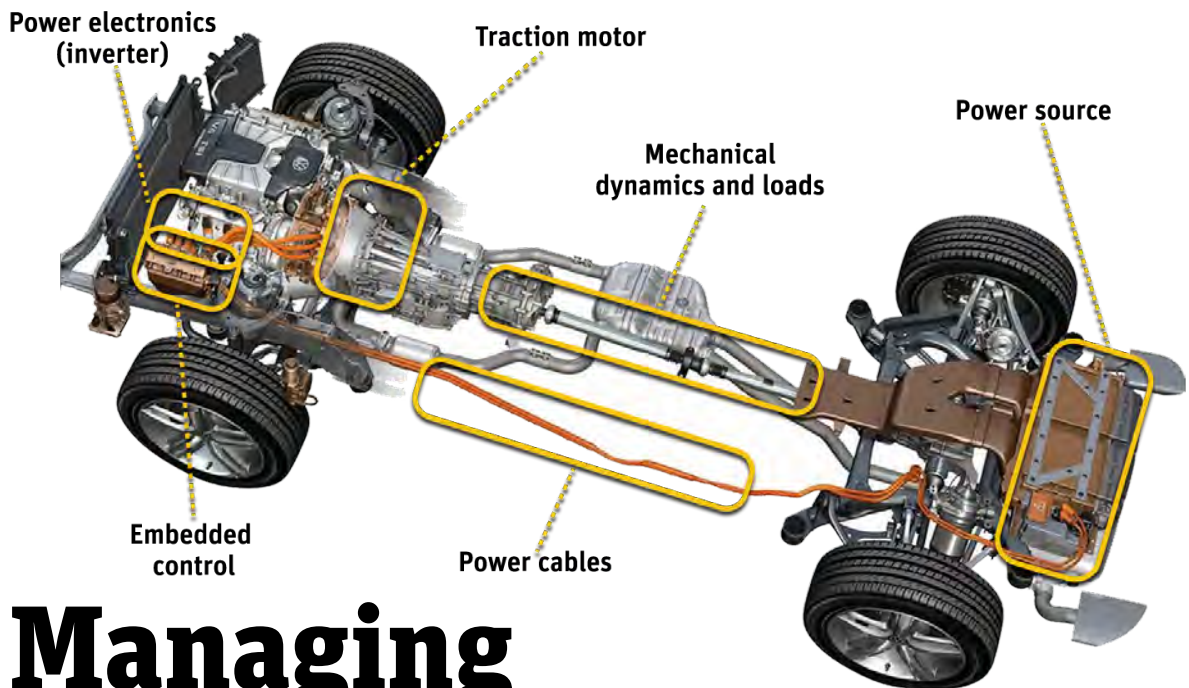

# Managing Large-Scale Battery Systems

By **Marc Born**, Chief Technical Officer  
**Manzoor Tiwana**, Product Manager —  
 ANSYS Twin Builder  
**Pierre Vincent**, Principal Consultant  
 ANSYS

Electrification for use by industries, including electrical mobility and distributed power generation applications, inevitably requires more batteries. This is obvious in rapidly growing transportation applications like automobiles and drones, and gaining prominence for energy storage and development of more electric aircraft. These batteries are not standalone but complex parts of larger systems

that must operate optimally to ensure safe and efficient energy usage. Battery management systems (BMS) include both hardware and embedded software for real-time monitoring and control of rechargeable batteries to provide reliable power in complex applications. ANSYS solutions for embedded software and functional analysis enable BMS development for secure, dependable and efficient battery operation.

**A**ccording to Statista [1], electric vehicles (EVs) are expected to grow from 1 percent of the overall car market in 2017 to 14 percent by 2025. Every major automobile manufacturer is developing vehicles to compete in this growing market. As vehicles become more and more electric, with large banks of batteries powering the engine, air conditioning and heating, and infotainment systems of the car, monitoring and maintaining the operation of the battery system will be a critical function. Engineers are developing battery management systems (BMS) to ensure the smooth operation of this complex network. This requires the use of state-of-the-art software tools.

## BMS Main Functions

A BMS is a sophisticated, software-driven control center of an electric vehicle. It is responsible for monitoring the cell voltage and temperature and preserving healthy operating



# “This combination of simulation tools is essential for rapid *virtual prototyping* of a BMS as more and more systems rely on battery power in the future.”

conditions; monitoring the state of the system connectivity; measuring current; calculating state of charge (SOC) and state of health (SOH); balancing electrical input and output among cells; and establishing connections between the battery and the powertrain or the charging system, among other functions.

In general, a BMS independently ensures the smooth, safe operation of a battery-powered vehicle at optimal performance conditions. It distributes resources where they can be put to best use and notifies the operator of potential problems well in advance. In a worst-case scenario, the BMS could physically disconnect batteries in the system to prevent damage or catastrophic failure that could endanger passengers in the vehicle.

Designing such a complex control center is a challenging proposition. ANSYS solutions help engineers design the BMS throughout the development process and even manage it in real time in its operating environment. ANSYS solutions for battery management include physics-based simulations to develop a system-level view of the battery using ANSYS Twin Builder, ANSYS medini analyze and ANSYS SCADE embedded code for the BMS.

## ANSYS medini analyze and SCADE Embedded Code for Battery Safety

ANSYS medini analyze performs key safety analysis procedures as specified by different standards in

different industries (including hazard and operability analysis [HAZOP], fault tree analysis [FTA], failure mode and effects analysis [FMEA], and failure mode effect and diagnostic analysis [FMEDA]). For automotive systems, it checks that the BMS software satisfies the ISO 26262 functional safety standard for road vehicles.

Safety analysis starts with the identification and description of functions and malfunctions of the BMS. Once malfunctions have been identified, a hazard and risk analysis (HARA) is performed to identify the hazardous events and their impact on safety by determining the automotive safety integrity level (ASIL) and corresponding safety goals and safety requirements. Some functions of the BMS require a rigorous development process, up to ASIL D, the highest safety integrity level in ISO 26262.

This requirement leads to very demanding safety requirements for the software as well.

A BMS typically has three architectural components:

- A battery pack (cell stack) containing several individual cells
- A switch box
- An electronic control unit (ECU) that includes the software controller to monitor the voltage, current and temperature of the battery cells

The embedded software in the ECU can be generated and verified automatically using ANSYS SCADE Suite. The SCADE product line provides a model-based development

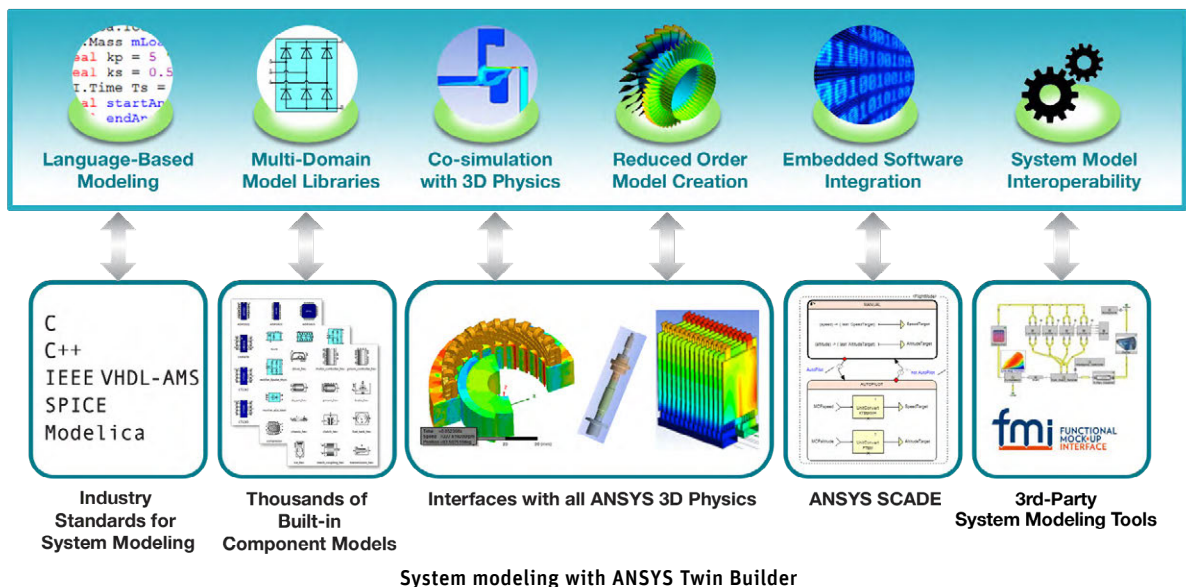

environment for critical embedded software, such as flight control and engine control systems. SCADE Suite drastically reduces project certification costs by simplifying critical control application design and automating verification, qualifiable/certified code generation and documentation generation. This tool generates embedded software that can be certified under various industry standards, including DO-178C up to level A for the aerospace industry, ISO 26262:2011 up to ASIL D for automotive, and IEC 61508 2010 up to SIL 3 for the functional safety of electronic systems.

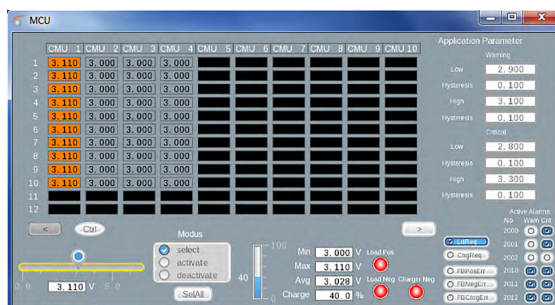

Software simulation with SCADE Rapid Prototyper

## MULTIPHYSICS SIMULATION FOR BATTERY OPTIMIZATION

The most popular batteries currently available are based on Li-ion technology, but researchers are constantly exploring other materials that will be more energy-efficient and less prone to overheating and burning.

For each system explored, scientists must make new discoveries about the fundamental processes of each material system. Because each material has unique thermal, structural, electromagnetic and electrochemical properties, ANSYS multiphysics solutions are needed to thoroughly model a battery system. OEM battery manufacturers and their suppliers use a combination of ANSYS Fluent for cell design, thermal management and thermal runaway; ANSYS Mechanical for structural stresses and strains produced by differential heating and cooling; and ANSYS Twin Builder for system-level modeling of a battery pack's operation. The complete solution helps engineers to account for all physical changes during a battery's design, manufacturing and operating lifecycle.

Fluent provides 3D computational fluid dynamics analysis based on a multiscale, multidimensional (MSMD) approach. This approach is effective for CFD simulation from the level of the materials ( $10^{-9}$  m) through the electrode pair ( $10^{-4}$  m) to the finished cell pack ( $10^{-1}$  m), covering up to 10 orders of magnitude in size. Fluent has three different electrochemistry models to optimize the power generation of the battery system.

Fluent can also be used to analyze heat flow between cells and modules in a battery to determine the temperature of prismatic-cell battery packs or cylindrical-cell battery packs under various forced cooling conditions. Controlling the temperature of a Li-ion battery is essential to prevent it from becoming too hot and, catastrophically, catching on fire.

As temperatures change in various parts of the battery during operation, materials expand and contract due to their different coefficients of thermal expansion. This expansion and contraction can produce compressive or tensile stresses on the battery's components, which could lead to deformation or failure if the induced strain exceeds a critical level for a given material. A two-way multiphysics simulation that couples Mechanical with Fluent can track the effects of temperature on the structure to ensure that the battery's components can withstand any thermal-induced stresses.

In an extreme case, such as when an EV is involved in a crash, thermal abuse of the battery is a concern. It starts with structural failure, which decreases the contact resistance in the impacted battery region. ANSYS Mechanical can simulate structural failure in these conditions and determine whether a new design will prevent failure. Next, electrochemical reactions in the damaged battery generate heat, which can lead to thermal runaway if the heat generation rate exceeds the heat dissipation rate. Fluent simulation can help engineers to design batteries that will be resistant to thermal abuse of this type. Again, multiphysics coupling of Mechanical and Fluent is required to give engineers a complete picture of the structural, thermal and electrochemical response of a battery to rapid changes that occur in unexpected crash conditions.

Finally, when all the components of a battery system are ready to be connected, ANSYS Twin Builder can simulate how they will work together to achieve optimal efficiency. Optimally designed components do not necessarily result in optimal systems. When these components are powered, sensed and controlled together as an integrated system, they might perform differently than when they were tested as standalone components. Twin Builder can perform closed-loop testing that encompasses the entire connected system to detect any component weaknesses and correct them to produce a battery system that operates at maximum efficiency.



# “A BMS independently ensures the smooth, safe operation of a *battery-powered vehicle* at optimal performance conditions.”

In the battery, operating conditions such as cell voltages, temperatures, and the overall pack voltage and current are monitored by the ECU. The ECU then sends data such as SOC and SOH (which compares the present condition of the battery to its ideal condition) to external components. It also transmits cooling and heating information.

Based on these outputs, the BMS can (1) adjust operating parameters to ensure that the battery is performing within its safe operating area (SOA), defined as the voltage and current conditions over which the device can be expected to operate without self-damage, and (2) perform an emergency disconnect of the battery in the case of a crash. If the BMS determines that the SOC or SOH is outside desired boundaries, it will issue a warning and/or move the system to a safe state.

## ANSYS Twin Builder for Complete System Simulation

The final step is to perform a complete closed-loop, system-level battery pack simulation using ANSYS Twin Builder to ensure that all components work together as designed. With Twin Builder, engineers create multiphysics models to design and validate system models of battery cells by simulating different physical effects, including the electrical and thermal behavior of the batteries.

Using Twin Builder, engineers can determine key design parameters like the peak power output of the battery system, the rate of charge and discharge of the batteries, the amount of heat generated by the operations, and the

effect of this heat on electrical performance. Twin Builder has a Modelica-based library that includes four templates for battery equivalent circuit models (ECMs), which are a function of SOC and temperature, to predict battery performance.

Beyond lumped-parameter models for the battery's electric circuits, Twin Builder takes advantage of ANSYS physics solvers' abilities to produce reduced-order models (ROMs). A ROM is a much smaller representation of the full-scale 3D model that can complete a simulation run in minutes or seconds without sacrificing accuracy, which is ideal for system-level modeling. A thermal ROM of the battery pack can be coupled in Twin Builder with the ECM model to determine the effects of heat on electrical performance.

## The Complete BMS Solution from ANSYS

ANSYS medini analyze ensures the safety of the BMS design, ANSYS SCADE Suite produces and verifies the embedded control software, and ANSYS Twin Builder enables engineers to test and validate a complete electrical system in an EV for efficiency and reliability. This combination of simulation tools is essential for rapid virtual prototyping of a BMS as more and more systems rely on battery power in the future. 

### Reference

[1] Statista. Projected U.S. electric vehicle market share between 2017 and 2025. [statista.com/statistics/744946/us-electric-vehicle-market-growth/](https://www.statista.com/statistics/744946/us-electric-vehicle-market-growth/) (01/31/2019)

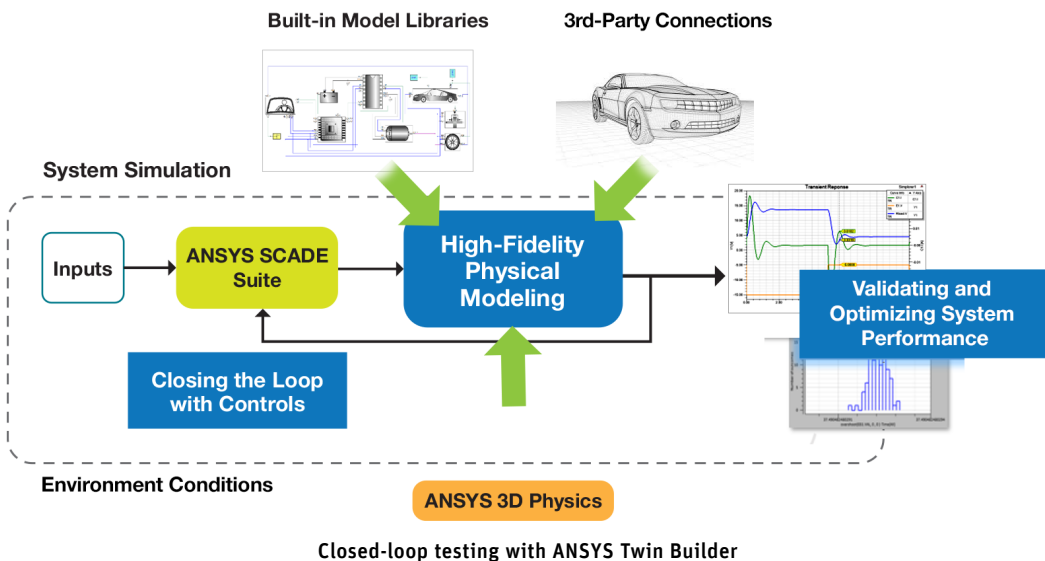

# Electrification of Aircraft Propulsion



To provide aircraft suitable for short-distance travel while reducing emissions, Zunum Aero is turning to electrification to create hybrid-electric systems. The challenge of developing these more electric aircraft requires the deployment of engineering simulation to achieve performance goals and to reduce the time and costs of testing.

By **Patrick Noble**, Propulsion Staff Engineer, Zunum Aero, Seattle, USA

**W**ith 13,500 airports in the United States, short-haul, regional air travel should be easy — a quick drive to a convenient air field and you are ready for takeoff.

Zunum Aero is determined to close the vast regional transport gap with the aid of technology for electric propulsion. The company, which is supported by Boeing HorizonX, Jet Blue Technology Ventures and the State of Washington Clean Energy Fund, envisions a door-to-door air system very different from today's jet-driven hub-and-spoke model of flying. Its coordinated network will eventually reach 5,000 secondary airports across





**“In my career, I have relied on ANSYS Mechanical products for over 20 years to develop the highly optimized solutions required for the aerospace industry.”**

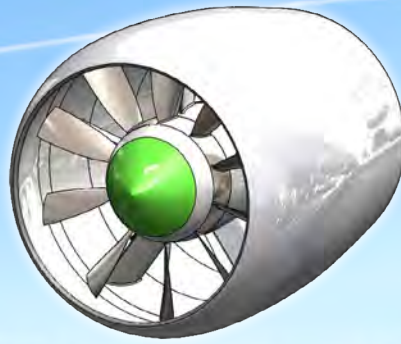

◀ Zunum Aero's Quiet Electric Propulsors offer range-optimized quiet fans with integrated electric motors.

the U.S. — and another 5,000 worldwide — with scale-independent hybrid-electric aircraft that reduce emissions and noise. Countries around the world include electrification in their lower energy, emissions and noise programs, such as CLEEN in the U.S. and Clean Sky in Europe.

#### **HYBRID-ELECTRIC PROPULSION**

Optimizing a quiet, lightweight hybrid-electric propulsion system with efficient aerodynamic designs is paramount to achieving the aircraft's performance objectives. To deliver a propulsor (a ducted fan prototype) for ground-based testing, Zunum Aero simulates component performance with several products from the ANSYS software suite obtained through the ANSYS Startup Program.

By accurately capturing the structural, aerodynamic and thermal loading behavior of each component,

Zunum Aero can make informed decisions about everything from large architectural issues — propulsor size, for example — to detailed system interfaces and joint behavior. Simulation provides a reliable way to prove concept feasibility, improve efficiency and optimize design before the hardware and test phases of product development.

#### **STRUCTURAL TESTING AND THERMAL MANAGEMENT**

The Zunum Aero Quiet Electric Propulsor combines low-pressure fans with integrated fault-tolerant electric motors and controllers. To understand how each propulsor component performs under all operational parameters, operating conditions and failure modes,



Electrifying the Aviation Industry  
[ansys.com/electrifying-aviation](https://www.ansys.com/electrifying-aviation)



Zunum Aero simulates behavior with a combination of ANSYS Mechanical, ANSYS Fluent and ANSYS CFX software.

Specifically, design engineers at Zunum Aero's test facility near Seattle, Washington, analyze the structural integrity of propulsion components with ANSYS Mechanical. Not only does the software allow the engineering team to simulate steady-state, modal and structural dynamics parameters, it also helps engineers to understand the complete response of each component individually and how they work together. In addition, engineers model internal and external flows for aerodynamic pressure loss estimates and design optimization using ANSYS CFD.

Because heat directly affects product reliability, the temperature of electrical components must remain within a set window. Zunum Aero uses ANSYS Fluent for thermal management. Engineers perform CFD fluid flow and heat transfer analysis to predict temperature and heat rejection, and to design the cooling system.

Although the company is still in its initial phases of designing, optimizing and integrating various thermal systems for the best overall aircraft-level performance, Zunum Aero senior principal engineer Dave Bedel says they could not have come this far without ANSYS simulation software.

"The scripting and parametric analysis capability of ANSYS Mechanical is essential for our work on the Zunum Aero Quiet Electric Propulsor," Bedel said. "In my career, I have relied on ANSYS Mechanical products

for over 20 years to develop the highly optimized solutions required for the aerospace industry."

#### APPLYING MULTIPHYSICS SIMULATION

Delivering a propulsion system is not a single-discipline assignment. In this case, it takes collaboration of engineers from Zunum Aero's power and propulsion groups to explore all the possible designs that could meet the propulsion requirements for the lowest-total-cost door-to-door aircraft.

Through its compatibility and integrations capabilities, ANSYS software enables multiphysics evaluations for faster design optimization. By simulating multiple designs, the design team can analyze more components at a proof-of-concept level in the virtual world, without having to spend time or resources on testing. In fact, it is estimated that, without simulation, validating the aircraft would have required nearly double the time. But even more than that, ANSYS helped Zunum Aero save millions of dollars in hardware tests.

#### EFFICIENT LOCAL AIR TRAVEL

Flights from thousands of airports that get travelers to their destinations at a fraction of the cost — with less noise to disturb neighbors and lower emissions for a healthier planet — is a lofty vision. But with the help of ANSYS simulation software, Zunum's goal of delivering a certified hybrid-electric aircraft is in sight. 

***“It is estimated that without simulation, validating the aircraft would have required nearly double the time.”***



# The Path of Least Resistance

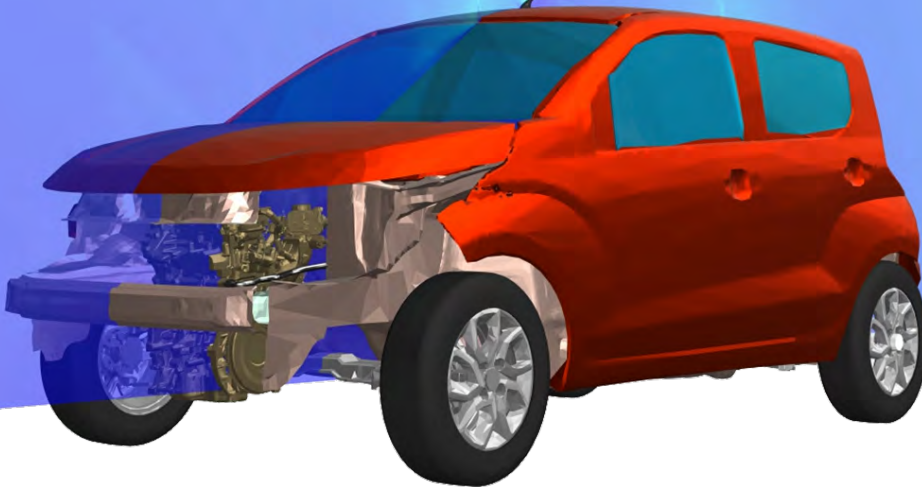

By **Bernardo Nogueira Giarola**  
EMC Product Analyst  
**Gabriel Alexandre Terra Almeida** and  
**Thiago Lucas de Oliveira**, Interns  
Fiat Chrysler Automobiles, Betim, Brazil  
and **Juliano Fujioka Mogni**  
Technical Consultant, ESSS, São Paulo, Brazil

**When lightning strikes an automobile**, the metal frame provides the path of least impedance to the ground, protecting the vehicle's occupants from injury. But as lightning flows over the frame or through the vehicle's electrical systems, it can damage sensitive components or even melt solder joints. The amount of electronics in vehicles is on the rise, so

protection from lightning is becoming more important than ever. Fiat Chrysler Automobiles, with support from ESSS, the ANSYS channel partner in South America, uses ANSYS electromagnetic field simulation software to model lightning strikes and predict their impact on vehicle electronics so that future vehicles can be designed to be more resistant to damage.

**V**ehicles now depend on their electronics systems for safety and reliability, and even to function. A loss of these systems is not only inconvenient but could be dangerous. About 70 percent of lightning strikes occur in the tropical regions of the world because they are more prone to the formation of clouds that produce thunderstorms. Fiat Chrysler Automobiles (FCA) Brazil is particularly interested in protecting vehicles from lightning because Brazil is the largest tropical country in the world and data suggests that lightning strikes Brazil around 80 million times per year. Testing vehicle performance in a lightning strike is expensive because engineers must rent special test facilities and build a prototype which could be destroyed in testing. FCA and ESSS engineers worked together to simulate the effects of a typical lightning strike on a Fiat Mobi city car. This project was not part of standard vehicle development.

 **Simulating Lightning Strikes  
in Maxwell**  
[ansys.com/simulating-lightning](https://ansys.com/simulating-lightning)



**“Engineers used ANSYS Maxwell to calculate the probability of lightning striking different areas of the vehicle.”**

### LIGHTNING AND AUTOMOBILES

Lightning in the vast majority of cases is an electric discharge between the negatively charged bottoms of clouds and the positively charged surface of the ground. When sufficient negative charges build on a cloud, a flow of negative charge, called a stepped leader, rushes toward the earth. The positive charges on the earth are attracted to the stepped leader, so they flow upward from the ground. When the upward and downward leaders meet, the resulting electric current is seen as a bright flash.

Lightning typically flows through conductive structures that have high charge density, such as sharp tips and corners, as it seeks out the path of least electrical impedance. This explains why lightning rods typically consist of pointed metal rods and why automobile antennas are a common lightning target. Lightning flowing over the vehicle body may induce an electric field that generates voltages and currents in wiring harnesses that travel to electronic control units (ECUs). This could potentially damage one or more of the scores of ECUs that function as the brains of the automobile.

The electric fields generated inside an automobile by a lightning strike are highly dependent on the geometry and conductivity of the vehicle exterior. In the case of a perfect sphere, the electrons forming the charge will spread out uniformly over the outer surface, canceling each other out with the result that no charge will be generated inside the sphere. In a vehicle with more complex geometries and differences in the conductivity of components, such as tires and windshields, significant internal electric fields may be generated; determining these fields is a challenging task.

Physical testing is far from an ideal solution because there are only a few facilities in the world capable of simulating a lightning strike. The cost of using these facilities runs into the millions of dollars and requires the construction — and possible destruction — of a prototype vehicle costing hundreds of thousands of dollars.



Lightning Strikes More Than Once  
[ansys.com/lightning-strikes](https://www.ansys.com/lightning-strikes)

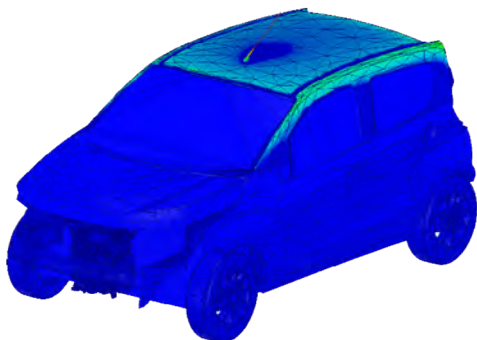

Electrostatic simulation shows electrostatic charge on each area of vehicle in an electromagnetic field.

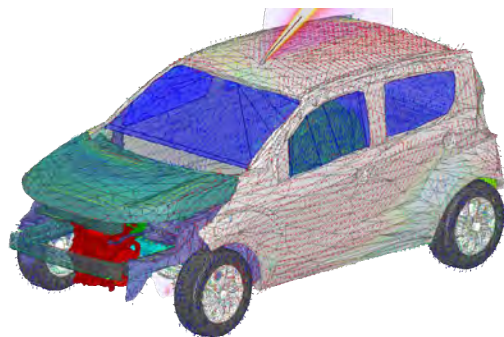

Transient simulation results show currents on the surface of vehicle as a result of a lightning strike.



## DETERMINING WHERE LIGHTNING IS LIKELY TO STRIKE

FCA and ESSS engineers first used the ANSYS Maxwell electrostatic solver to calculate the probability of lightning striking different areas of the vehicle. They generated an electric field throughout the solution domain by placing a charge of 100 coulombs on the top surface of the model and 0 coulombs on the bottom surface. When they first solved the model without a vehicle, the charge was evenly distributed throughout the solution domain.

Next, engineers employed a CAD model of a Fiat Mobi and applied electrical conductivity data to all the components based on data supplied by component suppliers and published data. They created low-impedance connections between metal components. They added this model to the solution domain and repeated the Maxwell simulation. The vehicle model caused the charge distribution to be distorted, and

strong fields were evident on sharp tips and elevated points of the vehicle. The probability of lightning striking any particular spot on the model is proportional to its electric charge. FCA and ESSS engineers confirmed that the antenna is the most likely area for lightning to strike a vehicle.

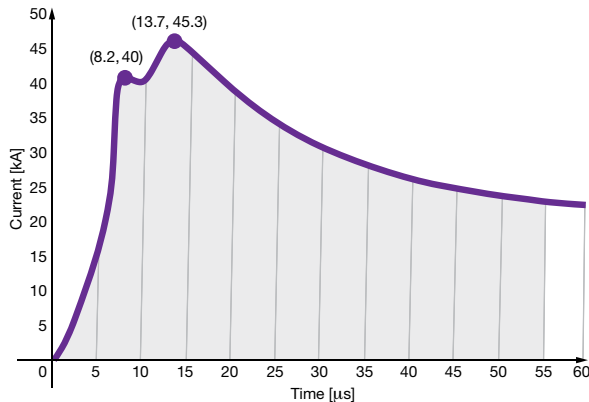

Pulse, modeled according to statistics of discharges, was applied to vehicle in transient simulation.

they applied a 45 kiloamp peak discharge into the vehicle. They also created a low-impedance return path from the ground back to the cloud.

The simulation results showed the electric currents and voltages on the exterior of the vehicle caused by lightning, and revealed the path through which these charges flow to ground. The simulation also showed the electric and magnetic fields created by these currents and the resulting currents induced on vehicle components, including the wiring harnesses. As expected, the highest currents were induced on geometrical features such as tips and edges. However, the effects of the geometry and conductivity of the vehicle exterior on the voltages and currents on the wiring harnesses required 3D transient electromagnetic simulation to unravel.

## IMPROVING THE VEHICLE DESIGN

Because they could simulate the effects of a lightning strike, engineers were able to investigate the potential for design changes to reduce damage to the vehicle. For example, they plan to determine whether increasing the conductivity of high-resistance components such as tires and windshields would reduce the electric fields inside the vehicle. FCA will soon simulate components with different conductivities and then work with suppliers to see what improvements can be made. Engineers also plan to investigate changes in the wiring harness such as changing the number of turns per inch in twisted cables, using different types of shielding for the wiring harness, and installing different connection points between the shielding and the chassis.

There are no standards for protecting automotive electronics against lightning strikes, but the proactive engineers at FCA are using simulation to look for solutions to reduce its impact on automotive electronic control units, antennas and wiring harnesses. Simulation enables engineers to accurately predict the current generated in wiring harnesses and other vehicle components during a lightning strike, making it possible to evaluate potential design improvements at a fraction of the time and cost required for physical testing. ⚠️

The antenna is the most likely area for a lightning strike.

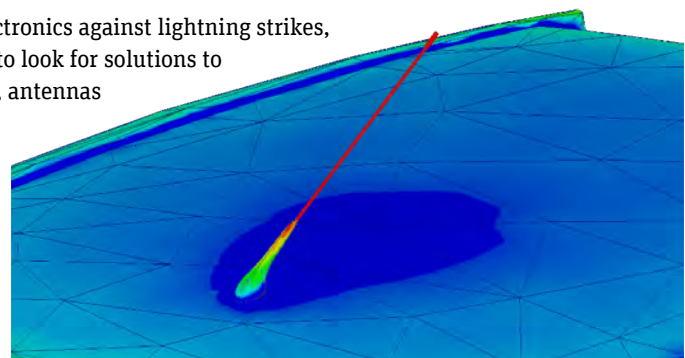

# *Next Generation of Electric Vehicle Motors – The Silent Treatment*

The switched reluctance motor (SRM) is a potential contender for the next-generation electric vehicle traction motor because of its low cost, high efficiency, and ability to operate at higher temperatures and in other harsh environments. However, SRMs are prone to torque ripple, which can generate troublesome noise in vehicles. Continuous Solutions used ANSYS Maxwell electromagnetic simulation software to reduce torque ripple by 90 percent and total noise by 50 percent in an SRM that will be used in the electrification of traction vehicles for agriculture machinery, mining machinery, and civil and tactical applications.

By **Nir Vaks**  
Chief Technology Officer  
and  
**Nyah Zarate**, CEO  
Continuous Solutions  
Portland, USA

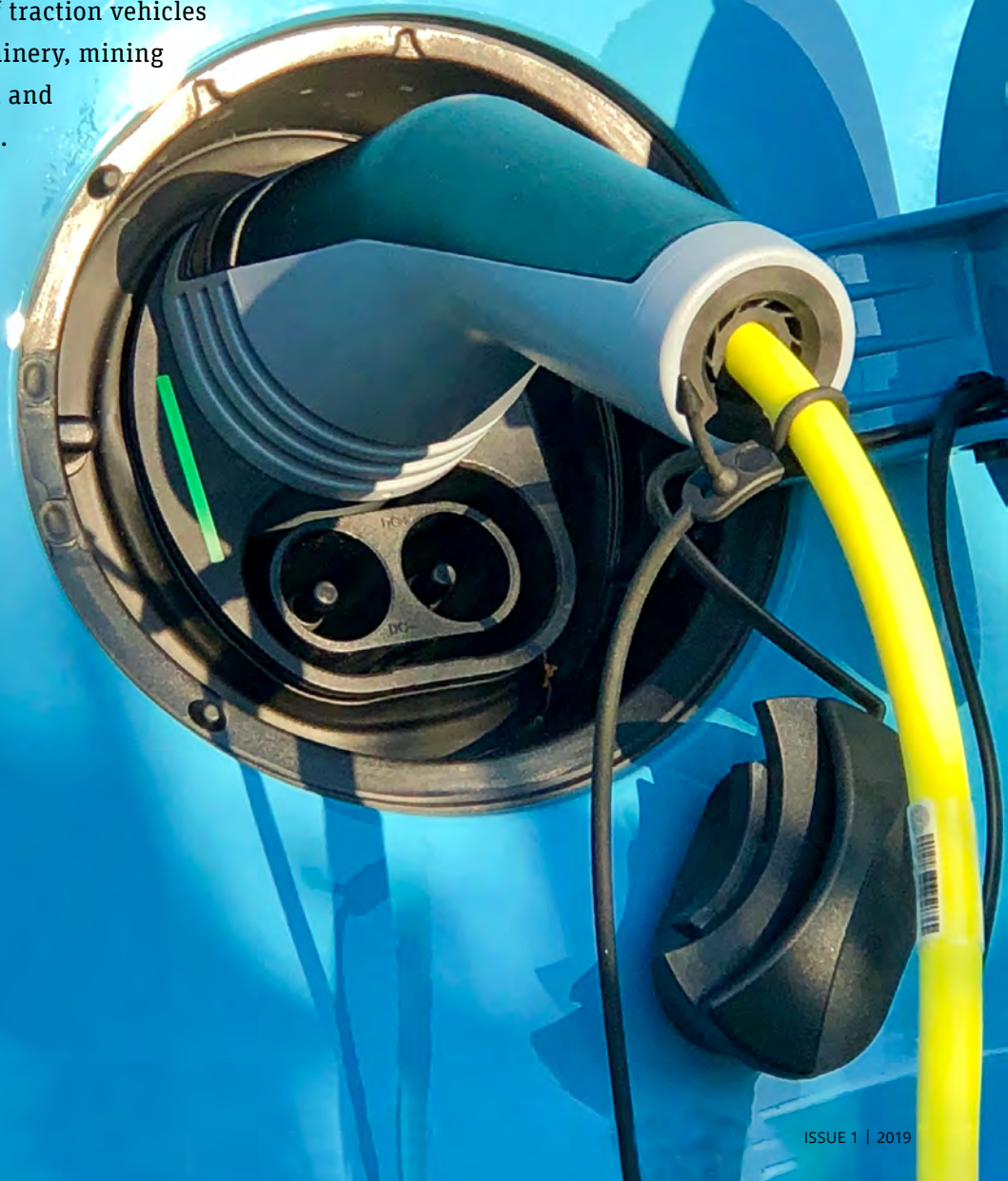

The concept of a switched reluctance motor (SRM) has been around for 180 years, but until recently it has only occasionally been used in industrial applications because of the complex circuitry required to control it. Over the last decade or so, high-powered microcontroller integrated circuits and computationally intensive control strategies have made SRMs more viable. A remaining challenge is the tendency of the SRM to emit considerable noise during its operation. This noise is unacceptable in applications such as luxury passenger cars, tactical vehicles and other machines in harsh environments.

Leveraging the ANSYS Startup Program, Continuous Solutions engineers address these challenges by producing virtual prototypes of prospective SRM designs in ANSYS Maxwell electromagnetic field simulation software. They model their control algorithm in Simplorer, Maxwell’s system simulation feature, and tune the algorithm to cancel out torque ripple, which substantially reduces the overall motor noise and vibration.

**“The new motor is 20 percent less expensive and operates at 50 percent higher temperatures than comparable permanent magnet motors.”**

**SRM BASICS**

The SRM operates based on magnetic flux. Magnetic fields are analogous to electrical current and prefer to travel in the path of least magnetic resistance or flux. This explains why low-reluctance materials such as iron and steel have a strong tendency to align to a magnetic field. The SRM uses phased windings on its stator, and its rotor is made of a low-reluctance material with alternating zones of high and low reluctance. When power is applied to the stator windings, the rotor’s magnetic reluctance generates a force that attempts to align the rotor pole – the low-reluctance peak – with the nearest stator pole. The SRM maintains rotation by switching the stator windings successively on and off so that the magnetic field of the stator causes the rotor to rotate.

The rotor can be made from a solid block of steel or built up from thin steel stampings with notches for the magnetic poles. The elimination of permanent magnets and windings on the rotor makes the SRM considerably less expensive to produce than conventional permanent magnet electric motors. The rotor carries no current, so there is no need for a commutator and armature coils as in a DC motor, nor for a cast-metal squirrel cage as in an induction motor. Furthermore, the elimination of permanent magnets and rotor windings enables the SRM to operate at higher ambient temperatures – a valuable attribute in vehicle traction motors.

**TORQUE RIPPLE CHALLENGE**

One of the greatest challenges in designing SRMs is that the inductance of each phase is proportional to the degree of alignment with the rotor poles. Excessive vibration and acoustic noise are generated

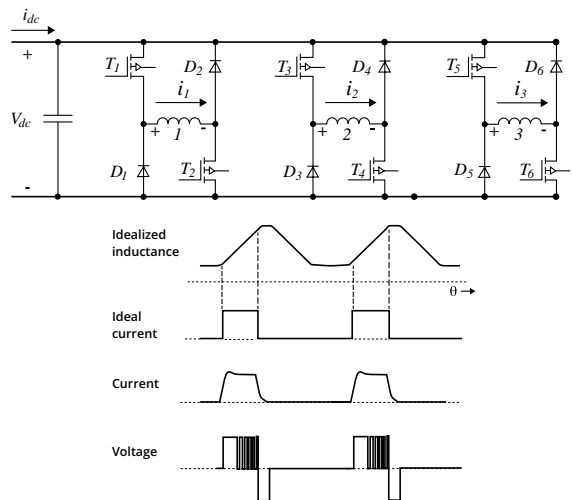

Asymmetric bridge converter circuit diagram (top) and resulting SRM waveforms

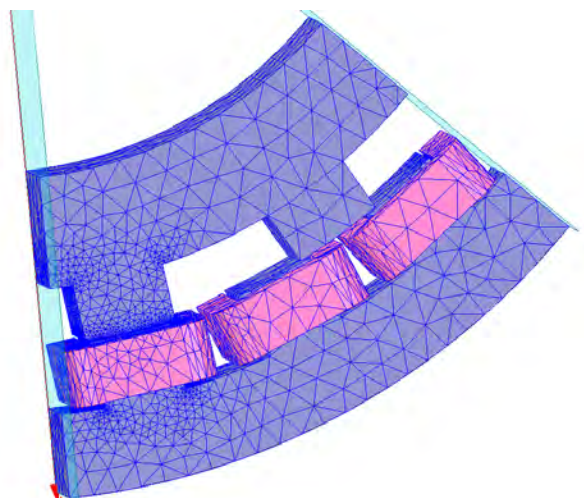

Model of SRM geometry in ANSYS Maxwell



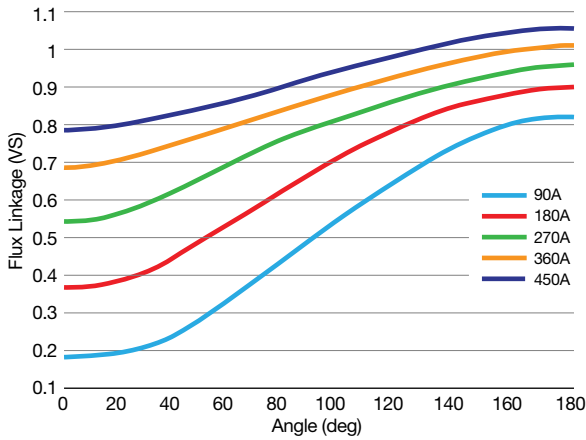

ANSYS Maxwell results show flux linkage as a function of rotor position at various loads.

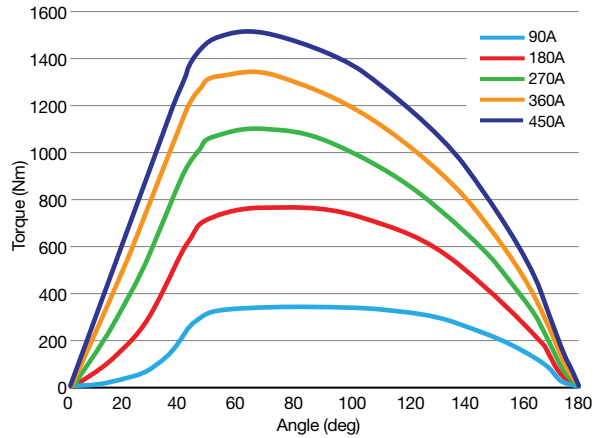

ANSYS Maxwell results show torque as a function of rotor position at various loads.

due to structural deformation and magnetic torque harmonics resulting from the stator-rotor interaction. Adding to this issue is the relative acute change in inductance as a function of rotor position and nonlinear control.

These interactions manifest as changes in torque known as torque ripple. Torque ripple can also be caused by mechanical issues such as imbalances in the rotor or stator. The result is vibrations that generate noise and can reduce the life of the motor.

In designing a new traction drive motor, Continuous Solutions' goal is to create a motor and drive that are less expensive and that can operate at higher temperatures than conventional permanent magnet motors while meeting efficiency, power density and noise targets equal to permanent magnet motors. Continuous Solutions engineers began by utilizing an in-house custom multi-objective 3D magnetic equivalent circuit (MEC) optimization program to speed the process of exploring the design space and identifying promising designs for further investigation. This program uses a genetic algorithm to explore various design parameters such as stator tooth height, excitation current and number of pole pairs, while iterating toward improvements in design objectives such as higher efficiency and lower mass.

### MODELING MOTOR DESIGNS

Continuous Solutions engineers developed detailed models of the promising design points identified by the optimization program in ANSYS Maxwell. They used ANSYS RMXprt, a template-based design tool, to quickly define the motor geometry. Rather than having to draw the components of the motor, they used the parametric design capabilities of RMXprt to define the SRM core. They entered the parameters of the core: the number of poles, and number and gauge of windings. They then created terminals and assigned excitations

to the windings. The engineers then duplicated the windings along the Z-axis of the motor. Next, they defined the stator structure by specifying the number of poles, adding windings and assigning terminals to the windings. They defined the motor enclosure.

Engineers then transferred the 3D geometry along with motion and mechanical setup, core loss in stator and rotor steels, winding and source setup directly to Maxwell for detailed finite element analysis. Maxwell calculated performance data such as torque versus speed, power loss, flux in air gap, power factor and efficiency. Maxwell produced a torque report that showed the moving torque of the motor in newton-meters as a function of rotational angle. For a more detailed diagnostic view, they plotted magnetic flux over a cross section of the rotor and stator at key points in the time history where torque hit peaks or valleys. These plots showed that one of the main sources of noise was the stator being squeezed toward the rotor by

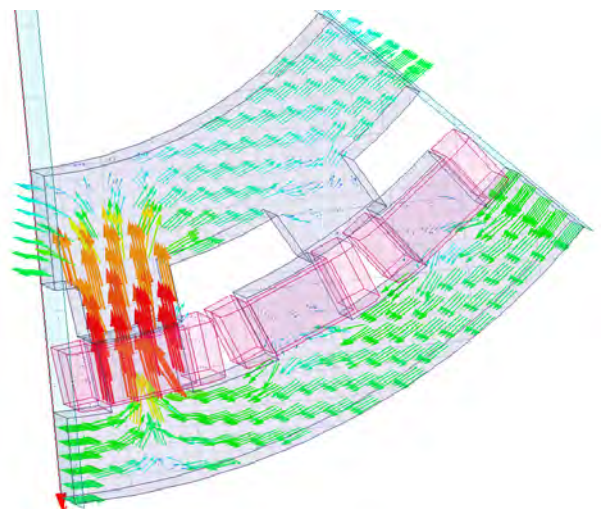

Magnetic flux plotted by ANSYS Maxwell on a cross section of rotor

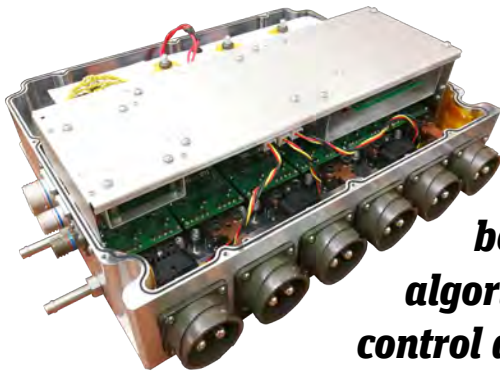

◀ Continuous Solutions 100kW SRM MILSPEC controller running Torque Ripple Mitigation technology

**“Engineers simultaneously improved both the motor design and the control algorithm until the integrated motor and control algorithm met all their objectives.”**

the attractive forces exerted by each pole pair as the stator is energized. One approach to this problem is to make the stator stronger, but this increases the cost and weight of the motor.

### DESIGNING THE CONTROL ALGORITHM

Instead of seeking a mechanical solution, Continuous Solutions designed the control algorithm to inject current into normally inactive windings at precise times to cancel errant force vectors from the active wings. They designed the control algorithm in their in-house analytical tools and embedded it into a regular SRM inverter included in Simplorer. Then they connected the Simplorer inverter to the ANSYS Maxwell model of the motor and drove the motor with the control algorithm. The torque time history and magnetic flux plots guided Continuous Solutions engineers in smoothing out the torque ripples. Just as the motor is about to jerk to the left, the controller injects a signal to jerk to the right, canceling out the

native motion and removing torque ripple wave. At the same time, engineers evaluated multiple design iterations in Maxwell to finalize the motor design. Over a series of iterations, engineers simultaneously improved both the motor design and the control algorithm until the integrated motor and control algorithm met all their objectives.

Continuous Solutions engineers proceeded to build and test a prototype of the new motor design, and its performance closely matched the simulation results. In addition, for mass manufacturing, Continuous Solutions has formed a strategic partnership with Nidec Motor Corporation to make this technology commercially available. The new motor is 20 to 50 percent less expensive and operates at 50 percent higher temperatures than comparable permanent magnet motors, while offering comparable efficiency, power density and noise performance. ⚠

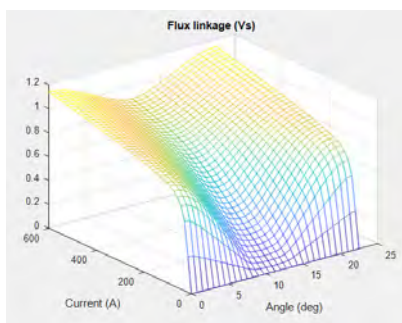

3D map of produced flux linkage as a function of current load and rotor position

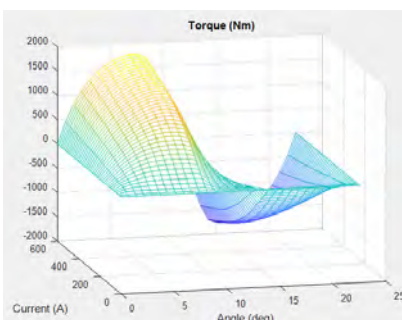

3D map of produced torque as a function of current load and rotor position

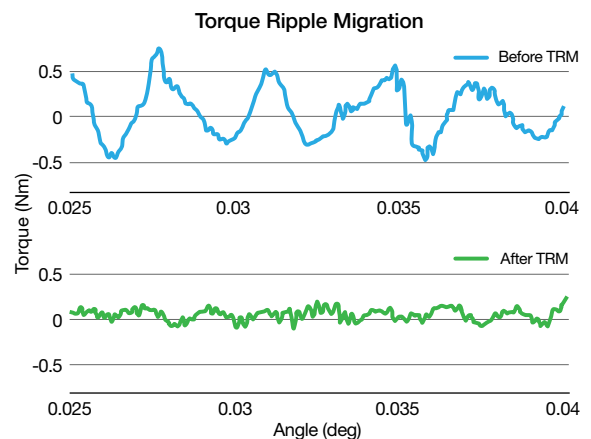

Reduction of torque ripple in SRM provided by Continuous Solutions Torque Ripple Mitigation controller



# Electrifying Solutions in Motors and Generators

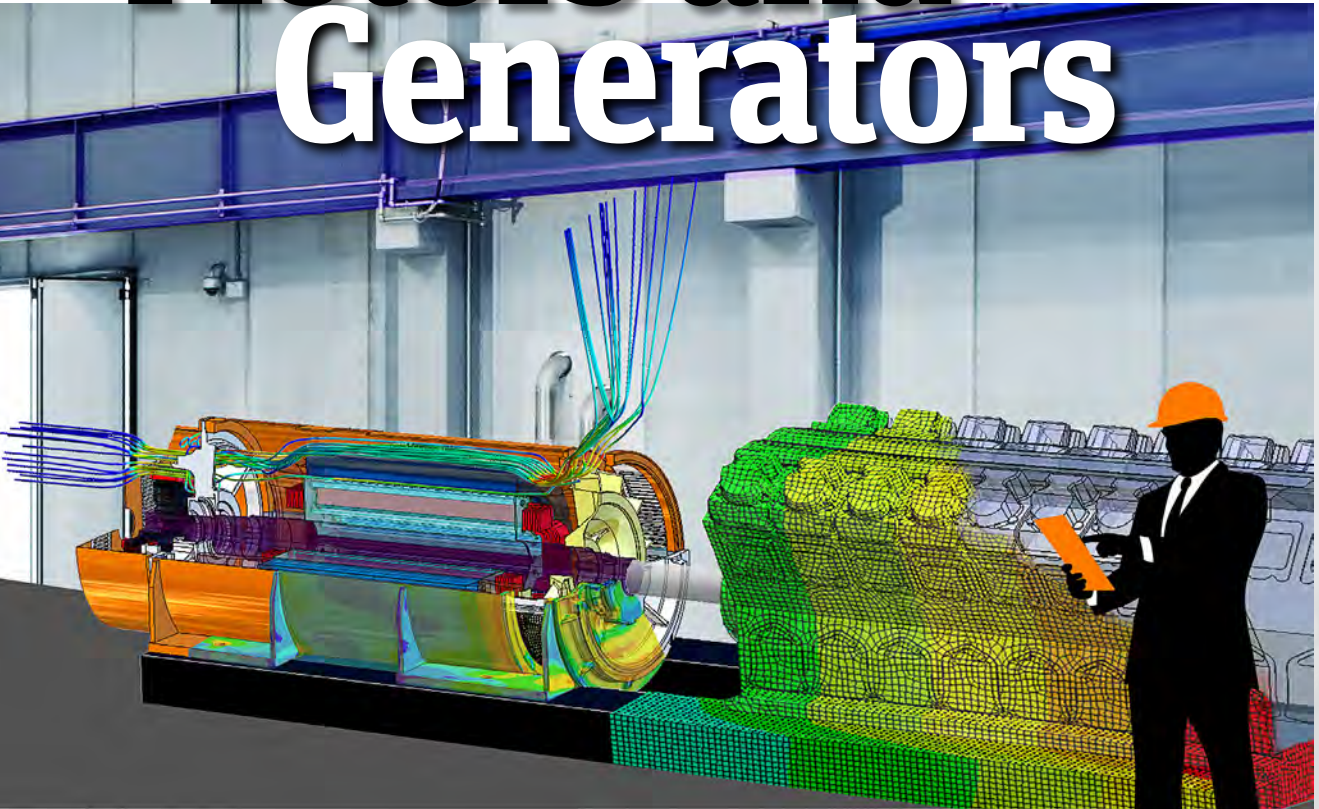

The market for electric power generation equipment is growing more competitive every day, with customers demanding more reliable, eco-friendly products at lower cost. Marelli Motori meets these demands using ANSYS Maxwell, ANSYS Mechanical and ANSYS CFX in multiphysics simulations to deliver the tailor-made solutions their customers have come to rely on. More recently, they have begun using ANSYS Discovery Live to obtain instantaneous simulation results with every on-the-fly change to a product's geometry or operating conditions, greatly reducing design time.

Multiphysics simulation of a genset (combination of diesel and electric generator) using ANSYS Mechanical and CFX

---

By **Nicola Pornaro**, R&D Mechanical Technologies Coordinator  
Marelli Motori S.p.A., Arzignano, Italy



**“The engineers used ANSYS Maxwell to identify hot spots in the coils and combined this analysis with an ANSYS CFX calculation to improve the heat exchange.”**

Electric motors and generators contain rotating magnetic coils through which electrons flow. The resistance of electrons flowing through wires, together with the friction generated by rotating devices, causes heat to build up. Energy lost as heat is unavailable to do work, reducing the efficiency of the motors and generators. Excess heat can also cause structural problems as temperature builds up in structural components and induces stress. Heat can be dissipated with cooling airflow, but the physics of the airflow must be optimized for maximum effect.

Because all these physical effects are happening simultaneously, a multiphysics simulation approach is needed. Marelli Motori engineers use ANSYS multiphysics solutions to custom-design motors and generators to solve challenges in hydropower, cogeneration, oil and gas, civil and commercial marine transport, military applications, and ATEX applications involving motors and generators in explosive atmospheres, among other applications. (ATEX consists of two EU directives describing what equipment and work space is allowed in an environment with an explosive atmosphere.)

#### **MECHANICAL, FLOW AND ELECTROMECHANICAL MULTIPHYSICS SOLUTIONS**

Marelli Motori engineers use ANSYS Mechanical to optimize the design of the frame, shields, cooling fan, motor shaft and generators. Structural simulations focus on reducing the weight of these components while optimizing stiffness. The R&D Team of Marelli Motori also simulates the response of the machine to the static and dynamic forces that are generated by the rotation of the rotor; excessive forces could lead to component failure through deformation, crack formation or fatigue.

Using ANSYS Workbench as a common platform to perform multiphysics simulations, Marelli Motori engineers run ANSYS CFX simulations along with structural ones to determine the design that best combines optimal structural integrity, thermal efficiency and cost reduction. The rotor assembly (including single or double cooling fans, depending on the machine air circuit), the stator and the heat exchangers (when needed) are the core thermal exchange components of the motor or generator. ANSYS CFX computational fluid dynamics (CFD) simulations increase the cooling efficiency and thermal exchange with the surroundings by optimizing the airflow through the machines. This reduces hot spots inside the generators and motors to increase efficiency and maximize power output.

Finally, adding ANSYS Maxwell to Mechanical and CFX in multiphysics simulation completes the optimization process. The only way to reduce forces that create motor vibrations is to extract the magnetic forces using Maxwell and export them into a Mechanical analysis to evaluate the harmonic response of the frame. Maxwell is also used to identify hot spots in the coils and combine this analysis with a CFX calculation

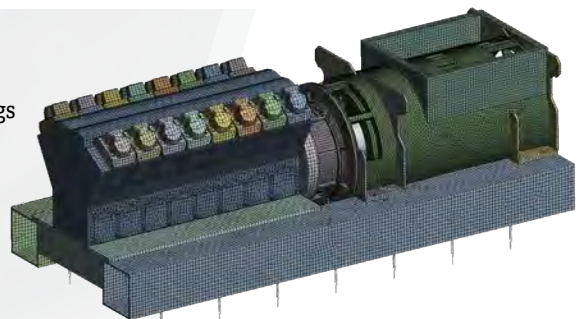

**Example of a genset with Marelli Motori's alternator installed in a hospital in Germany**

to locally optimize the design and improve the heat exchange. ANSYS Multiphysics simulations yield higher-quality results in 60–70 percent less time than other simulation products that Marelli Motori engineers have used in the past.

### MANUFACTURING CHALLENGES

Even after the design has been optimized using mechanical, flow and electromechanical simulations, the challenge of building the motor or generator most efficiently and effectively remains. Marelli Motori engineers want to facilitate the construction operations while keeping mechanical safety and reliability for each operating condition firmly in mind. This is the most challenging part of the engineering workflow, because while the engineers are trying to design a family of components to optimize heat extraction from the machine, they must simultaneously consider constraints regarding shape feasibility, production cost and ease of final assembly. Using ANSYS Mechanical and ANSYS CFX together in a multiphysics simulation guides the engineering team to the best manufacturing process. A recent project to develop a new series of small alternators with the latest technological improvements took much less time using ANSYS simulation.



All the CFD simulations that lead to a redesign are subsequently evaluated in a test room. Here, some of Marelli Motori's motors for industrial applications are being tested.

### APPLICATION EXAMPLES

Obviously, the importance of the various design parameters changes with each application. In marine applications, motors and alternators must be silent with very low vibrations to avoid ruining the experience of the ship's passengers. Structural finite element analysis and harmonic response calculations using ANSYS Mechanical must be performed on the frame and other components to reduce sound and vibrations.

A genset is a combination of an internal combustion engine with an electric motor or alternator, used as a standby electric power supply. Vibrations from the diesel engine can excite natural frequencies and harmonic responses in the system. Marelli Motori engineers run modal analysis in ANSYS Mechanical to find these frequencies and harmonic responses, which vary according to operating conditions, to analyze the dynamic behavior of the alternator. This is followed by a collaboration between the customer and the genset designer to avoid any possible resonances of the entire genset with the surrounding structure for each design project. If this upfront analysis was not done, and the completed genset generated vibrations and structural noise inside a vessel, correcting the problem would result in tremendous additional costs and project delays.

In power generation applications, increasing efficiency is the most essential step. This mainly involves applying CFD simulations to improve the airflow to cool the machines

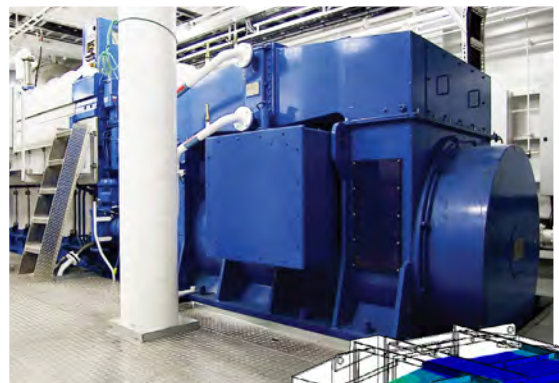

Max power generator in a marine application and simulation of its alternator

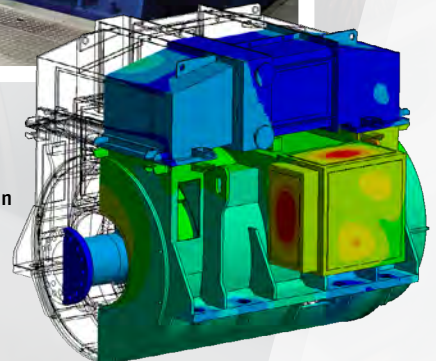



and coupling the results with EM simulations that optimize the electrical parts by reducing losses. Marelli Motori engineers perform this multiphysics simulation daily. All modifications introduced after numerical simulations are evaluated in a test room to demonstrate benefits in terms of temperatures and efficiency according to international norms.

### USING SIMULATION FOR IDEATION

Marelli Motori was one of the first companies to adopt ANSYS Discovery Live when it was released early in 2018. Discovery Live is the first simulation solution to enable engineers and designers to make changes to geometry and other properties while a simulation is running and instantaneously view the results of these changes. With their commitment to promptly satisfy their customers with high-quality, reliable, customized products, Marelli Motori realized that such rapid simulation results would help them to react to their customer's needs faster. In one case involving simulation of a heat exchanger on a closed alternator, an experienced

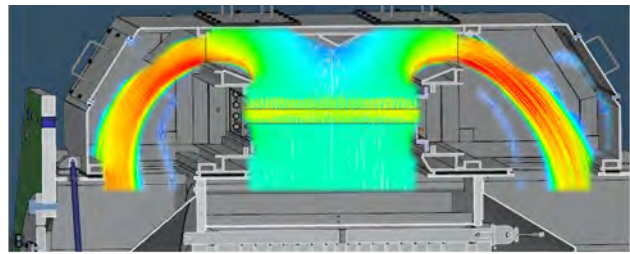
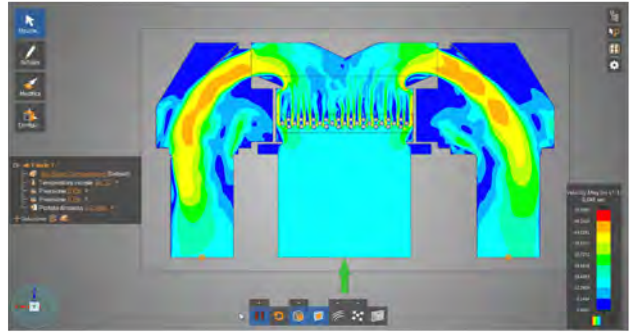

Example of a heat exchanger simulated using ANSYS CFX. An expert user completed five simulations in eight hours. Using ANSYS Discovery Live, a user completed many simulations in two hours to achieve an optimal design.

**“When simulating a heat exchanger on a closed alternator, an experienced ANSYS CFX user analyzed five different designs in eight hours; with ANSYS Discovery Live, the same engineer reached an optimal design in two hours.”**

CFX user analyzed five different designs in eight hours; with Discovery Live, the same engineer reached an optimal design in two hours, a savings of six hours.

ANSYS multiphysics simulations helped Marelli Motori engineers to design the best components for their customized electric motors and generators and become more competitive in the worldwide market. Their customers appreciate the increased efficiency, cost reduction and shorter development times, along with the greater reliability provided by the synergy between Marelli Motori and ANSYS simulation. 

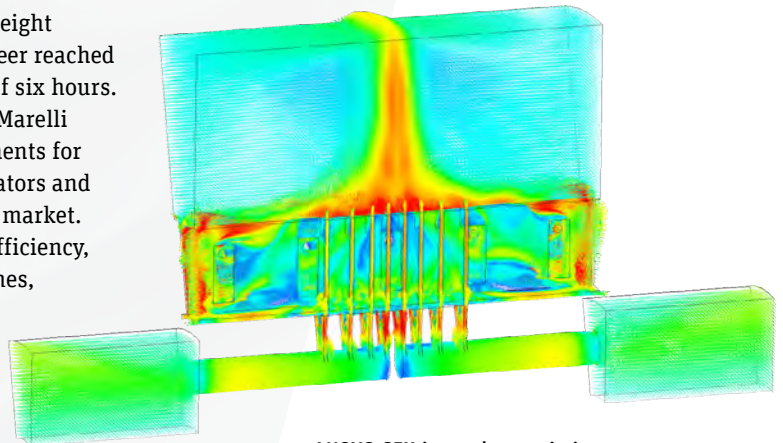

ANSYS CFX is used to optimize the cooling channels inside a rotor.



# Powering Up for the Future

WEG direct-drive wind turbine AGW 110/2.1MW

By **Mateus Nicoladelli de Oliveira**  
Applied Technology – R&D  
WEG Energy  
Jaraguá do Sul – SC, Brazil

As the need for electricity continues to grow around the world, meeting this demand requires renewable energy technologies. Brazilian company WEG, a longtime leader in design and production of electric machines, has the expertise to deliver these renewable energy systems and components. WEG Energy leverages ANSYS solutions throughout the design process – and even during product operation – to develop reliable renewable energy equipment.



Taking Turbomachinery Simulation to the Next Level  
[ansys.com/next-level-turbo](https://ansys.com/next-level-turbo)

**T**he size of the global renewable energy market will reach approximately \$1062.4 billion by the end of 2024, growing at a compound annual growth rate of 13.1 percent from 2018 to 2024, according to market research company Envision Intelligence. To decrease greenhouse gas emissions while meeting increasing demand for electricity, many countries are investing in renewable technologies for their power plants. WEG supplies solutions for such plants.

Founded in 1961 as a small factory producing electric motors, today WEG is a global manufacturer and provider of a range of energy solutions.

Renewable energy technologies within WEG’s Energy division include wind turbines, turbogenerators and hydrogenerators. Engineers must produce these high-quality products according to demanding schedules and within cost constraints. Testing these large, complex machines at every stage of development would be too costly and time-consuming, so the team applies engineering simulation from the early stages of the design process and throughout product development. WEG engineers rely on ANSYS’ comprehensive solutions for structural, electromagnetic and thermal simulation.

Most of WEG’s renewable energy solutions are nonstandard designs that must be customized according to each project’s requirements and operating conditions. This level of customization requires flexible, comprehensive and accurate engineering simulation. For WEG’s new 4 MW direct-drive wind turbine platform, engineers used ANSYS Mechanical and ANSYS Maxwell simulation solutions from the start of the design process and throughout development. Turbogenerators in steam turbines that are used in thermoelectric plants have a high power density. This intrinsically generates excess heat that must be properly cooled. WEG engineers used ANSYS CFX computational fluid dynamics (CFD) simulation software for thermal management, resulting in efficiency improvements. For hydroelectric generation, the hydraulic turbine design requires combinations of ANSYS BladeModeler, ANSYS TurboGrid, ANSYS CFX and ANSYS DesignXplorer to explore the turbine construction parameters combined with system variables to develop efficient, robust equipment.

---

**“The WEG team applies engineering simulation from the early stages of the design process and throughout product development.”**

---

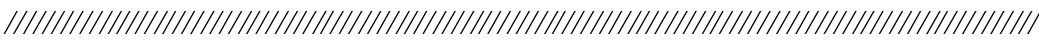

## Doubling Wind Turbine Output

With increased competition in the wind power market, WEG is developing a 4 MW direct-drive wind turbine that almost doubles the output of its current 2.1 MW platform. Being developed in partnership with WEG engineers in the U.S., this new, larger turbine exhibits high efficiency and low maintenance.

High dynamic loading caused by increased power output required ANSYS Mechanical for structural simulations of the wind turbine’s various components. The main challenges in designing the rear chassis of the wind turbine were the geometrical complexity of the component and the evaluation of many different load cases. Using ANSYS Mechanical and ANSYS DesignXplorer,

WEG engineers simulated all structural aspects of the part, including the evaluation of critical welding spots that have high loads and manufacturing process characteristics, to produce a tough, reliable component.

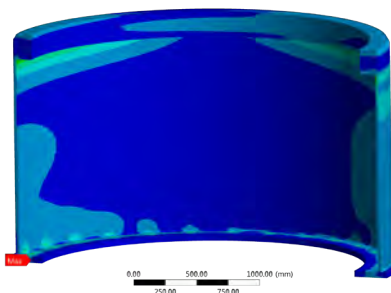
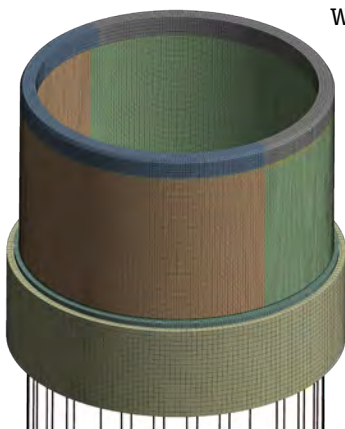

◀ Nacelle tower-top adapter (left). Evaluation of neck stress and welding point (right).

The nacelle tower-top adapter, which couples the top of the concrete tower to the bottom of the nacelle and its yaw bearing, must withstand extreme loads, avoid plastic deformation and not slip during the wind turbine's lifetime. Engineers used structural simulation to evaluate stresses at the neck and at welding points and ANSYS nCode DesignLife for fatigue failure analysis.

In addition to ANSYS Mechanical, WEG engineers used ANSYS Maxwell extensively to simulate low-frequency electromagnetic fields to evaluate torque, induced voltage, losses and magnetic core saturation. One of the key criteria when developing electrical equipment such as wind turbines is to minimize harmonic currents between the generator and the power converter. To maintain low total harmonic distortion (THD), engineers used simulation to analyze magnet positioning to determine the generated voltage and harmonic spectrum.

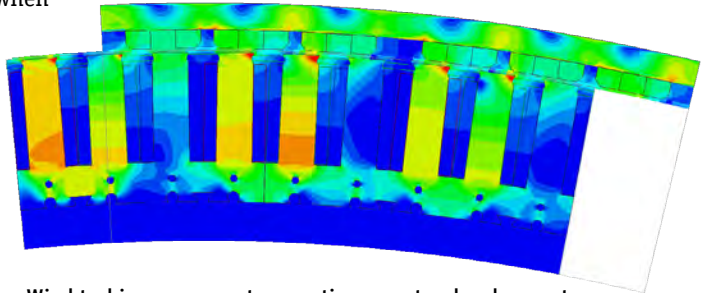

Wind turbine permanent magnetic generator development using ANSYS Maxwell

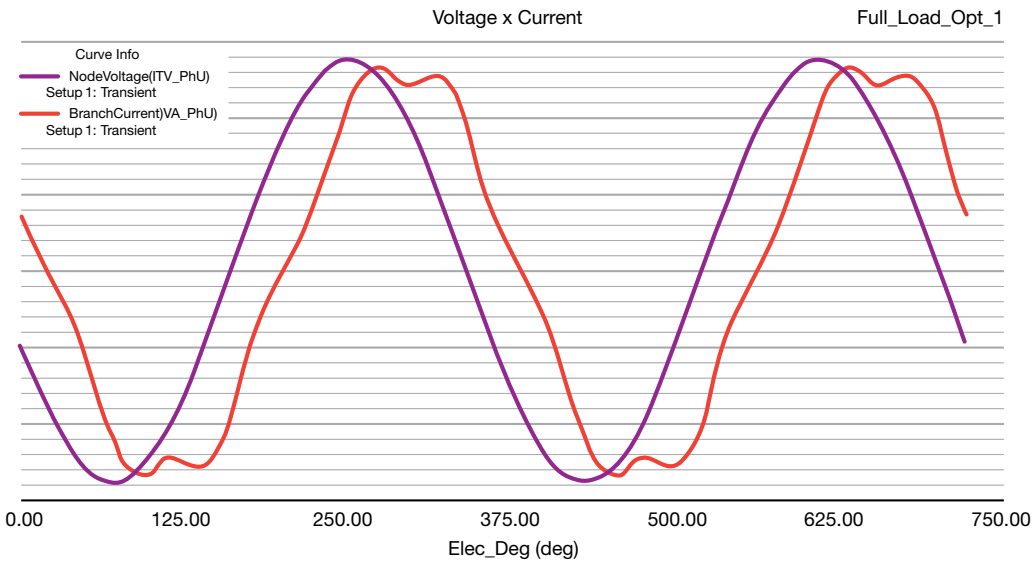

Voltage and current of the wind turbine with a full load operation

Overall, ANSYS simulation solutions proved to be invaluable in the development of the 4 MW platform, enabling the engineering team to rapidly validate and refine the design.

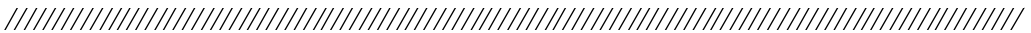

### Developing and Evaluating Electric Generators

WEG has been producing electric generators for over 30 years. For each new product, engineers evaluate every innovative feature through in-depth simulation. For example, a new project usually requires thermal analysis because an increase in power output or a machine size reduction intrinsically impacts the machine's thermal heating versus cooling balance.

To illustrate one innovation, WEG wanted to replace the steel cover that contains the rotor coil head with an alternative material in a new line of turbogenerators. The engineering team explored the use of a pre-impregnated composite material in the form of a banding tape instead of a retaining ring. They used ANSYS Mechanical to evaluate the radial displacements of the banding for two imposed conditions: the strain in the components of the coil head and the residual contact pressure of the banding. The result was a fully validated component with a lower rotor mass that is also cost-effective to manufacture. New materials, like the composites in this case, can reduce feedstock costs by as much as 77 percent and wound rotor manufacturing costs by 18 to 20 percent.



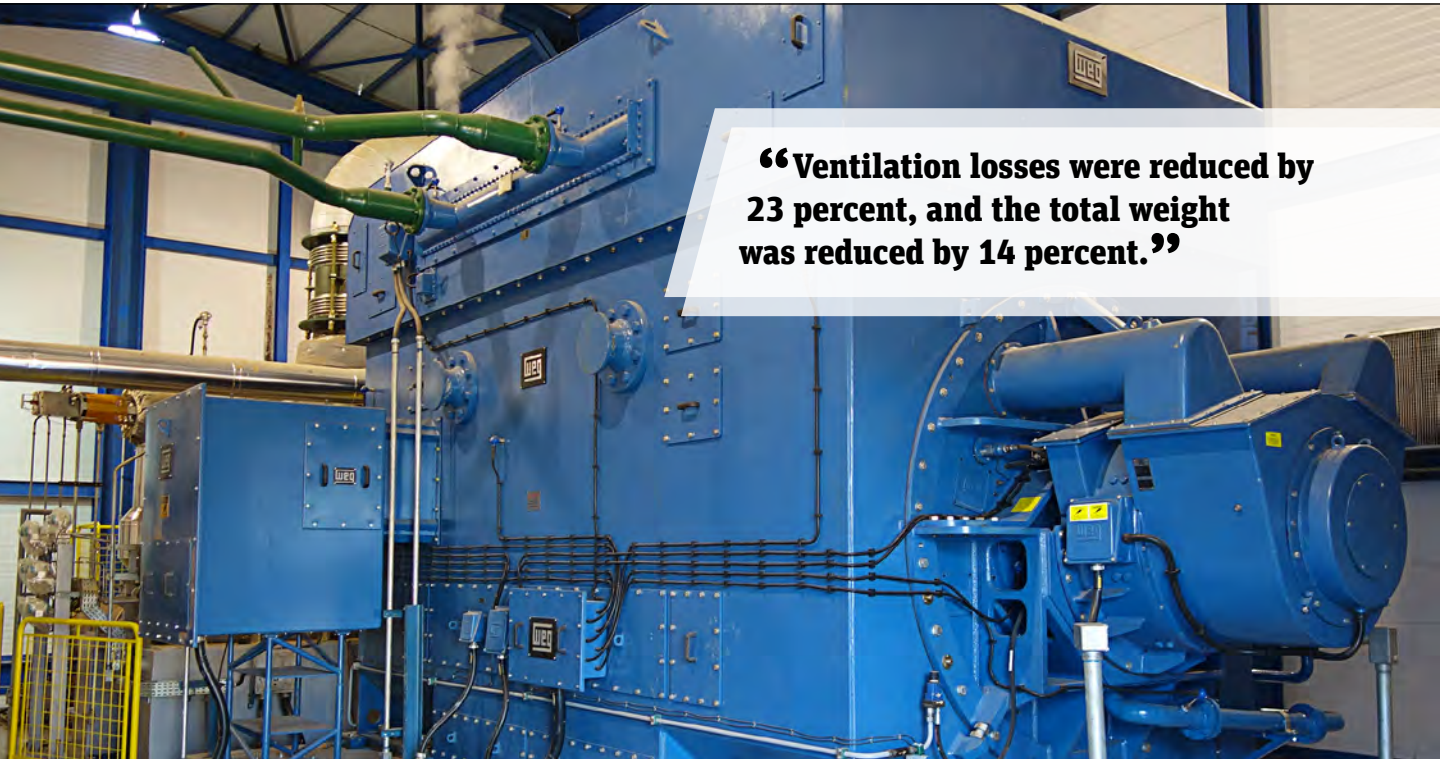

**“Ventilation losses were reduced by 23 percent, and the total weight was reduced by 14 percent.”**

**WEG generator installed at end-user plant**

Besides structural improvement in these generators, WEG also wanted to increase the efficiency of the generator cooling system through better air distribution. WEG engineers used ANSYS CFX to determine the airflow through the rotor and stator coils to detect any hot spots. The result was a more uniform thermal distribution, leading to increased machine performance and reduction of windage (air resistance) losses. Ventilation losses were reduced by 23 percent, and the total weight was reduced by 14 percent.

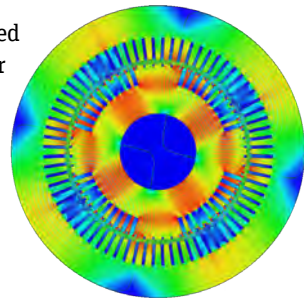

**Cylindrical pole generator simulation using ANSYS Maxwell showing induction and flux lines for an asymmetric model with full load operation**

For electromagnetic analysis during development, ANSYS Maxwell provides valuable insights about the generated voltage as well as magnetic core saturation and losses. Additionally, the versatility of Maxwell helps WEG engineers to evaluate design alternatives, predict performance and diagnose potential faults under certain operating conditions. For instance, if a machine shuts down due to a stator coil short circuit, or if the stator requires repair or specific coils need to be replaced, the machine might be out of service for some time. To continue operation, the failed stator coils can be disconnected as a temporary repair. However, the resulting nonsymmetrical current distribution tends to cause overheating. Using the ANSYS Maxwell transient solver, WEG engineers can determine the effect of the temporary repair on the machine’s performance by carrying out a detailed electromagnetic analysis to predict the phase and path current distribution, estimate the harmonic impact and calculate the derating factors. The derating factor indicates the level to which the machine output power must be limited based on the temporary repair. ANSYS tools enable WEG engineers to view complex phenomena and address any issues.

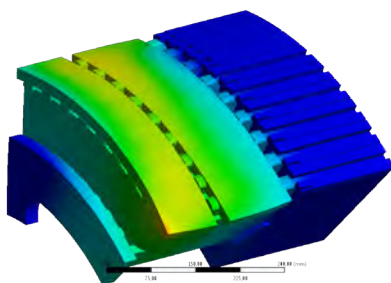

**Banding radial displacement evaluation with ANSYS Mechanical**

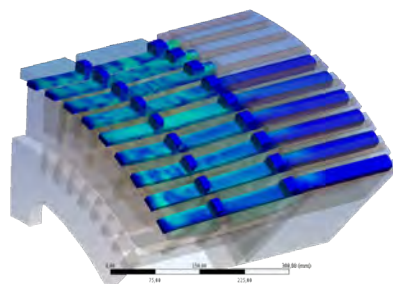

**Banding residual contact pressure evaluation with ANSYS Mechanical**

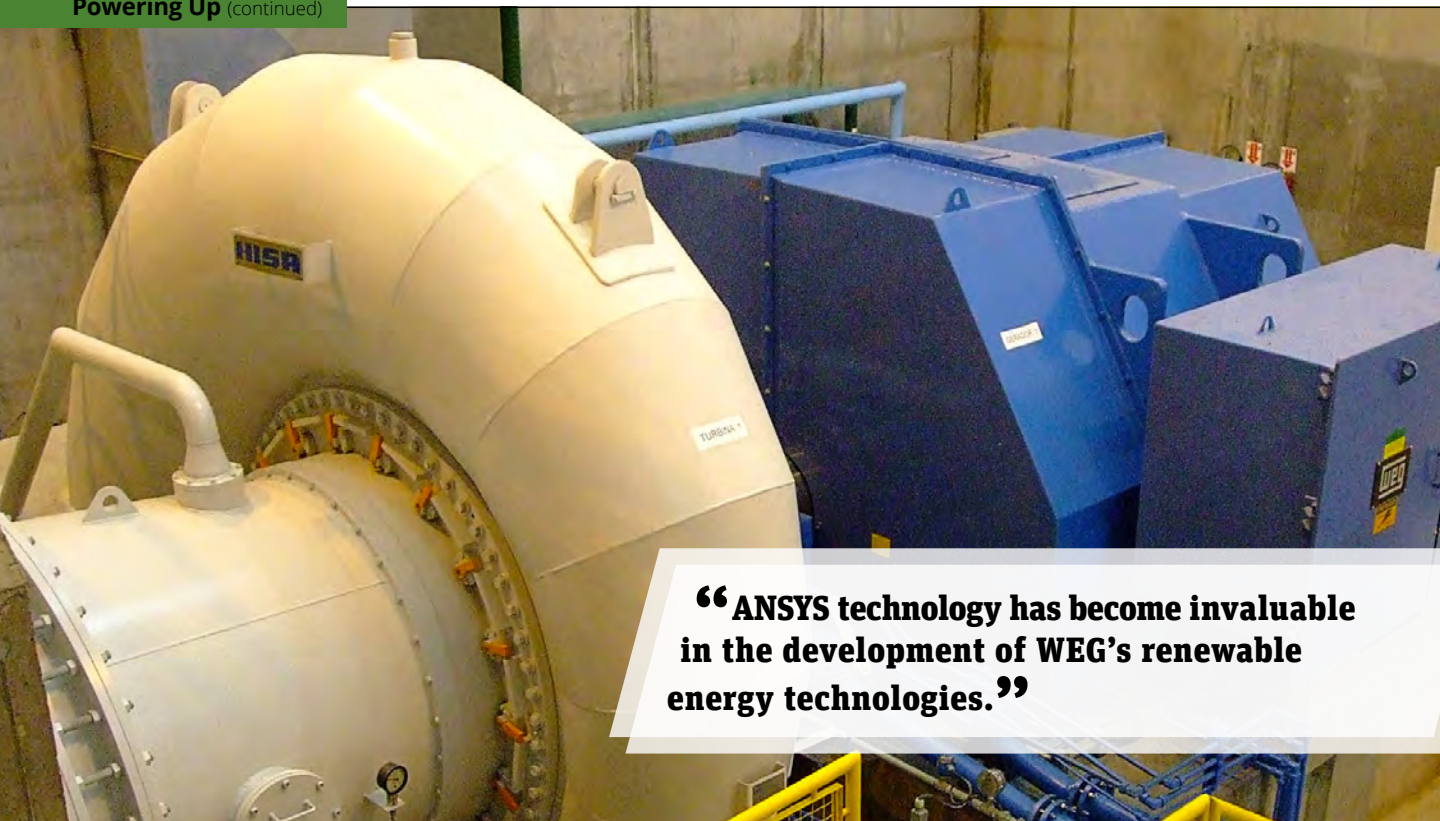

**“ANSYS technology has become invaluable in the development of WEG’s renewable energy technologies.”**

Francis turbine and WEG generator during a commissioning event

### Hydraulic Turbine Design Exploration

The fluid dynamics of a hydraulic turbine during operation are quite complex. For hydro-power generation, the location and the unique geographic characteristics of each project affect conditions like pressure, water flow rate and water head level. Simulation is used to effectively account for all the parameters involved and can be combined with turbine construction parameters, such as in a Francis turbine, which includes radial and axial flows.

Using ANSYS CFX, WEG’s engineers examined the working pressure fields and velocity profile to estimate the turbine parameters for a wide range of operating conditions. Using ANSYS Workbench, they parameterized components such as stay and guide vanes and easily deployed ANSYS turbo tools to evaluate important characteristics through meridional cross section and blade-to-blade section. This enabled engineers to virtually observe the water flow through the hydraulic contour and blade profiles.

Optimizing the efficiency of a hydraulic turbine for a wide range of operating conditions is a challenging task. To assist in creating the most efficient turbine, engineers use ANSYS CFX to generate a turbine Hill Chart for each nonstandard project, consisting of efficiency rate curves that describe the performance for different combinations of operational conditions. WEG’s engineers input data from simulations carried out using CFX in conjunction with ANSYS DesignXplorer into this chart.

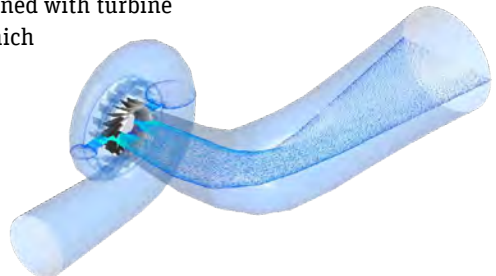

Complete model of Francis turbine simulated with ANSYS CFX

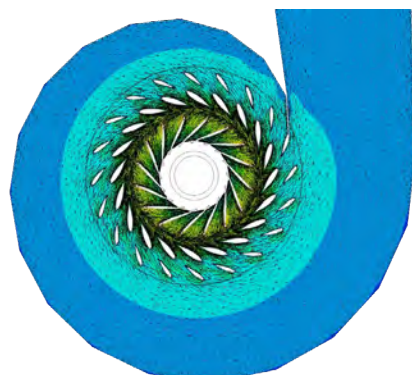

Velocity simulation for stay guide vanes and runner blades of a Francis turbine



Turbomachinery Simulation 10x  
[ansys.com/turbo-10x](https://www.ansys.com/turbo-10x)



This enables them to explore and experiment with a range of different machine parameters such as blade shape, guide vane positioning, and spiral case and draft tube behavior.

The engineering team also carries out complex studies, including the verification of runaway turbine speed and the existence of cavitation regions, which can damage the runner blades. In the event of runaway turbine speed, critical parameters, such as overspeed and spiral case overpressure need to be deeply analyzed to ensure safe mechanical levels.

Virtual models help to evaluate these parameters before machine manufacture. One method of studying cavitation is to identify and evaluate areas of low water pressure in the liquid state. However, the most accurate method is to study the state of the water (from fluid to vapor) as the machine operates in these low-pressure areas. Simulation is an effective method of doing this.

Having discovered the most efficient combination of input parameters on a virtual model, WEG makes the product and gets field data to close the engineering information loop. Using simulation, WEG can manufacture hydro turbines with the confidence that they will be reliable, efficient, high-performing machines. ⚠

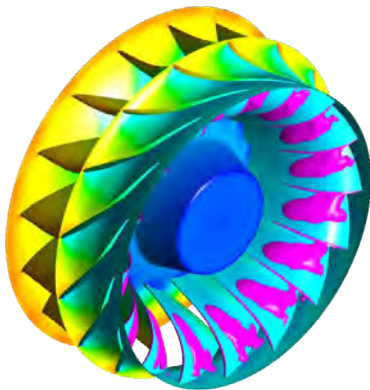

Francis turbine runner design simulation using ANSYS CFX

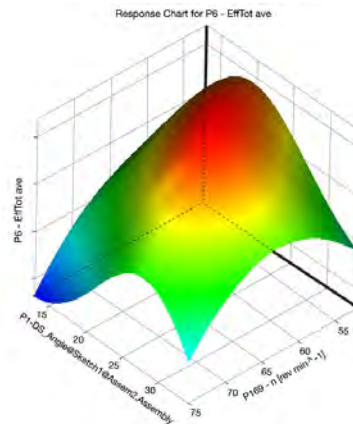

Francis turbine Hill Chart curve, wherein red indicates the better efficiency values

## Expanding the Use of ANSYS Simulation Solutions

ANSYS technology has become invaluable in the development of WEG's renewable energy technologies, particularly in the design of customized and nonstandard solutions. Simulation enables the engineering team to minimize uncertainty and mitigate risk. WEG engineers use simulation for product inception, design iteration, virtual prototyping and even forensic analysis after operation. It is applied to most of the company's products to determine the optimal design based on a wide range of physics. WEG Energy is expecting to expand its use of engineering simulation; the team that uses ANSYS software is growing. In WEG's vision of the future, engineers anticipate using ANSYS tools in digital twins, which are real-time, virtual copies of operating machines.

At WEG Energy division, simulation helps engineers cut time and cost from the development process and create reliable, high-performance machines. In 2018, Milton Castella, director of engineering at WEG, accepted the Innovation Brazil Award for WEG. During the ceremony he stated, "In 2016, approximately 50 percent of our revenue was generated with products developed within the past five years." ANSYS has played a vital role in helping WEG achieve this milestone.

*ANSYS elite channel partner ESSS provides training in ANSYS simulation software for both beginners and experts.*

*Contributors to this article from the WEG Energy team are Rodrigo C. Cossalter, Andre Eger, Diego S. Montero, Ricardo L. Sartori, Jhonattan Dias, Guilherme S. Porepp, Danielle R. Voltolini, Elissa S. de Carvalho, Angelo P. de Carvalho, Leandro Schemmer, Tarcisio W. Junior, Lessandro Bertagnolli and Carlos Ogawa.*



# Protecting Fusion Reactors from Extreme Heat

By **Julien Hillairet**, RF Research Engineer  
**Zhaoxi Chen**, Mechanical Research Engineer  
**Jonathan Gerardin**, Thermal Transfer Research Engineer and  
**Marie-Hélène Aumeunier**, Optical Research Engineer  
French Alternative Energies and Atomic Energy Commission (CEA)  
Cadarache, France

< 30 to 60 MHz ion-heating antenna installed into the CEA WEST machine



**NUCLEAR FUSION**, the process that powers the sun, has the potential to generate virtually unlimited amounts of greenhouse-gas-free and safe energy on earth. Although fusion power has long been pursued, the benefits of developing a reliable system to generate this energy is well worth the effort. French Atomic Energy Commission engineers are using ANSYS software

to overcome the difficult challenges involved in designing and protecting fusion reactor components, which must face plasma temperatures that reach 150 million degrees C. ANSYS electromagnetic and structural simulations are leveraged to design components to withstand enormous thermal loads; ANSYS fluid dynamics software is applied to cooling system design; and optical simulation is used to calibrate infrared temperature measurement systems so that engineers can accurately distinguish bright spots caused by direct heat flux from heat flux merely caused by reflections.

***“With a single antenna prototype costing millions of euros, accurate simulation is critical to the development of nuclear fusion as a potential energy source.”***

Generating electricity from fusion reactions requires that hot plasmas be maintained at enormous temperatures. To achieve these temperatures, CEA's tungsten (W) experimental superconducting tokamak (EST) reactor injects several megawatts of high-energy radio-frequency (RF) radiation into the plasma using antennas that are a few meters long and half a meter wide, and weigh several tons. Because these antennas are extremely close to the hot plasma, CEA uses ANSYS multiphysics software to design the antennas to resist thermal stresses generated by the plasma's heat flux, ohmic heating and RF reflections. ANSYS software can simulate infrared measurements of the plasma-facing components to ensure their accuracy. Simulation helps CEA increase the RF performance of these antennas and reduce their cost and the number of prototypes required, resulting in a savings of millions of euros.

#### **ANTENNA DESIGN CHALLENGES**

Plasma is a state of matter in which the electrons have been torn from their parent atoms, so the electrons and ions move independently. Plasma is conductive, so running an electric current through it heats it as if

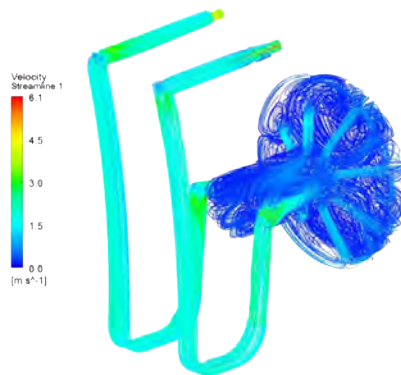

**ANSYS Fluent simulation shows pressure distribution in water-cooling circuit of antenna.**

it were a radiant space heater. Because plasma resistivity decreases as its temperature rises, this method can achieve temperatures of a few tens of millions of degrees, but still higher temperatures are needed. To raise the temperature beyond this level, the CEA research machine WEST (tungsten [W] environment in steady-state tokamak) injects powerful RF waves in the plasma. As the plasma radiates an intense heat load on the antennas — a few tens

of kilowatts per square meter ( $\text{kW}/\text{m}^2$ ) on average and megawatts per square meter ( $\text{MW}/\text{m}^2$ ) in the hottest areas — the antennas must be cooled by internal circulating-water channels to limit the temperature to a maximum of a few hundreds of degrees. In addition, the megawatts of RF power generate additional heat fluxes from ohmic losses in the antenna, and some of the RF power is reflected from the plasma back to the antenna. The antenna must also withstand mechanical





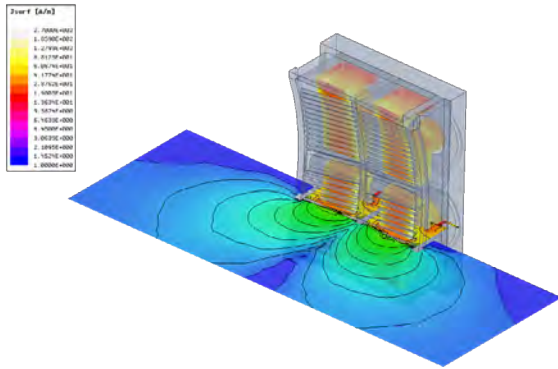

ANSYS HFSS model of the magnetic field generated by 50 MHz antenna

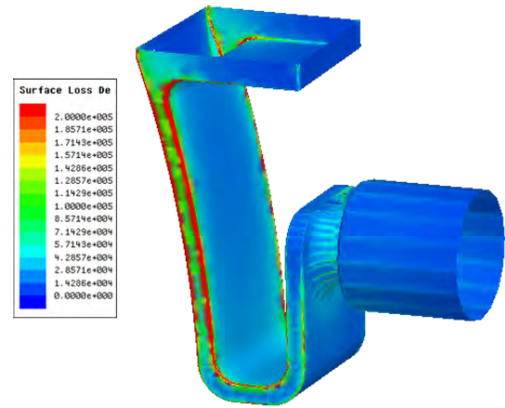

HFSS simulation shows ohmic losses on 50 MHz antenna.

loading during the sudden loss of plasma confinement, a phenomenon — called disruption — that occurs when plasma becomes unstable. During this event, the electrical current circulating in the plasma falls from a few million amperes to zero in 10 milliseconds or less. This generates substantial mechanical torque on the plasma-facing components such as the antenna.

**SIMULATING THERMAL LOADS**

CEA engineers use ANSYS HFSS to optimize the RF design of the antenna to maximize the energy transferred from antenna to plasma and to predict ohmic loads for subsequent thermal stress analysis. Modeling the radiating medium is complicated by the fact that the magnetic plasma is inhomogeneous — its density and temperature increases from its edge to its center — and nonlinear in both the frequency and the spatial domains. At the plasma edge near the antenna, the plasma can be approximated

with a gyrotropic medium, which has been altered by the presence of a quasi-static magnetic field. At the request of CEA and the International Thermonuclear Experimental Reactor (ITER), a multinational experimental fusion reactor under construction, ANSYS added the ability to support complex gyrotropic mediums to HFSS so it can be used to model the plasma edge facing the antenna.

The thermal loads on the antenna include the ohmic losses, the heat flux

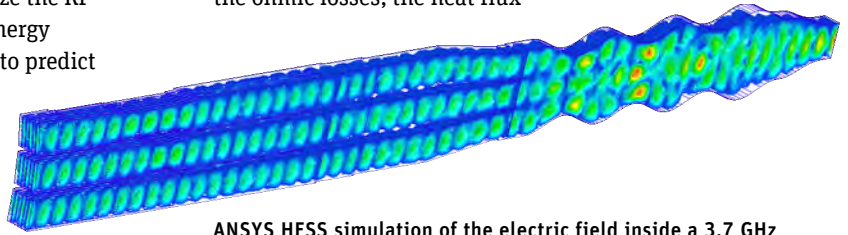

ANSYS HFSS simulation of the electric field inside a 3.7 GHz antenna. The RF power is injected from the right side of the picture and flows toward the left side. The power is divided in three (in the vertical direction) then in six (in the horizontal direction) and is phase-shifted before being launched to the plasma.

**FUSION POWER**

Fusion power could be an ideal energy source. It runs on hydrogen isotopes (such as deuterium, which can be found in sea water, and tritium, which can be generated inside the reactor), does not generate greenhouse gas and creates no radioactive waste except the reactor vessel itself. It requires much less land mass than wind or solar power installations for similar power and could produce power 24/7. But producing a self-sustaining fusion reaction requires that isotopes of hydrogen — deuterium and tritium — be heated to over 150 million C, a temperature at which they become plasma: an electrically charged gas that is common in space but rare on earth. At these temperatures, deuterium and tritium fuse to form helium, a neutron and large amounts of energy. Sustaining such a high temperature requires that the plasma be contained by magnetic fields generated by superconducting electromagnets.



generated by the plasma, and the RF power reflected by the plasma back to the antenna. The plasma heat flux and the reflected RF power are determined by previous physical experiments and physics models. The ohmic losses, as mentioned earlier, are calculated by HFSS. ANSYS Fluent computational fluid dynamics (CFD) software is used to optimize the fluid flow and heat transfer through the cooling channels. ANSYS Mechanical finite element analysis (FEA) software takes all these thermal loads into account and calculates the temperatures at every point in the antenna. ANSYS Mechanical then converts these temperatures into thermal stresses, adds them to the mechanical stresses, especially the torques generated by disruption events, and determines the stresses and deflections throughout the antenna. Fatigue analysis using ANSYS Mechanical is performed to determine the lifetime of proposed designs, especially the number of disruption events they can handle.

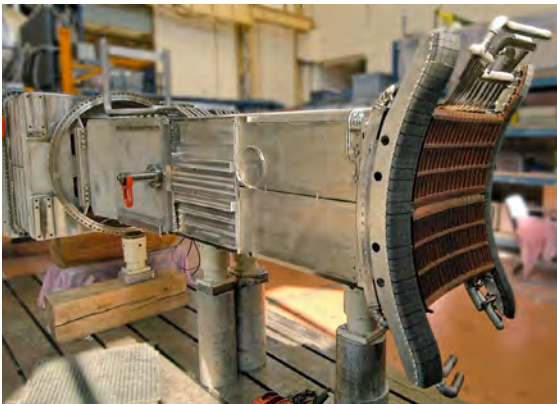

Plasma current drive antenna in isolation  
*Courtesy: C. Roux, R. Volpe, CEA*

### SIMULATING INFRARED MEASUREMENTS

The heat load on the antenna and other plasma-facing components depends upon many factors that cannot be fully simulated in advance. In particular, infrared (IR) cameras are used to monitor the antenna's surface temperatures so that the plasma can be safely shut down before these expensive components are damaged. Verifying the accuracy of these temperature measurements is critical. For example, the IR system needs to be able to detect very small hot spots and temperature gradients. Because the metallic environment of the tokamak is highly reflective, multiple reflections from hot regions will interfere with the thermal signals used to evaluate surface temperatures, leading to inaccuracies. Inaccurate temperature measurements could result in unnecessary (and expensive) shutdowns of the reactor if the temperature is overestimated. In the inverse case, if the temperature is underestimated, there is a risk of damage to the in-vessel components.

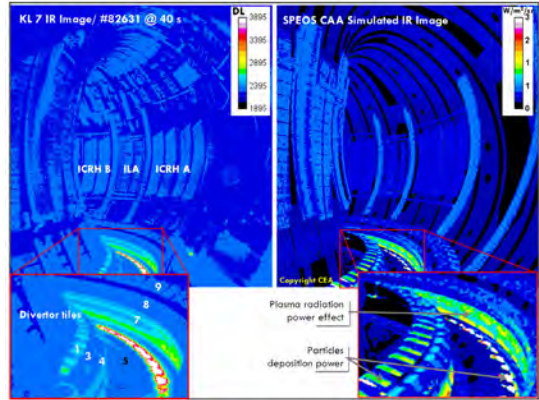

ANSYS SPEOS simulation (right) correlates well with IR image of fusion reactor (left).

To address these challenges, CEA uses ANSYS SPEOS software to simulate the ability of the IR system to measure the temperature of the antennas and other components in the vessel such as the lower divertor (a region of the tokamak that receives the largest part of the heat load from the plasma). SPEOS models the complex physical phenomena involved in the interactions of photons with matter and their propagation inside the IR system. This software predicts the radiometric images that will be generated by different types of materials in order to anticipate how the aging of materials will affect future IR imaging. SPEOS is used to predict the global response of the complete IR system by considering all the infrared sources, the 3D geometry of the tokamak, and material properties as determined by the surface bidirectional scattering distribution function (BSDF). SPEOS is also used to model the IR camera, including its geometrical optical properties such as its dimensions, wavelength range, spectral transmittance and pixel count. The simulations determine the actual IR images that will result from different surface temperatures, enabling the IR system to be calibrated to deliver accurate measurements (for example, to correct false hot spots due to reflection).

With a single antenna prototype costing millions of euros, accurate simulation of the electromagnetic interactions between magnetized plasmas and RF antennas, the thermal stresses on the antenna, and IR temperature measurements on the antennas are critical to the development of nuclear fusion as a potential energy source. ANSYS multiphysics software helps CEA engineers address all these challenges as they move toward producing fusion power on the scale of modern electric power plants. The result is that the number of full antenna prototypes has been substantially reduced, and the time to design antennas has been reduced from five years to one year. Simulation has also helped CEA engineers increase the performance and reduce the manufacturing cost of these antennas. ⚠

# Catching the SUN

By rotating solar panels to follow the sun across the sky, solar trackers can generate more power. These solar power plants can be damaged by aeroelastic instability at modest wind speeds. CPP Wind Engineering used simulation to determine the nature of the instability and to identify operating procedures and design changes that can prevent them.

By **Christian Rohr**, CFD Manager and **Peter Bourke**, Operations Manager, CPP Wind Engineering, St. Peters, Australia

**Single-axis solar trackers that automatically rotate to follow the sun from east to west** can generate 10 percent to 30 percent more power than stationary or “fixed tilt” solar panels. Certain wind conditions can cause a torsional instability that damages solar trackers. CPP was commissioned by several tracking companies, including NEXTracker, to investigate these kinds of failures and develop a solution. CPP used ANSYS Fluent computational fluid dynamics (CFD) software in conjunction with wind tunnel testing to re-create the conditions under which the trackers became unstable. CPP identified the cause of the problem and demonstrated how it could be solved through adjustments in operating conditions and design changes.

## SOLAR TRACKERS

Single-axis trackers consist of photovoltaic panels mounted to a long shaft, called a torque tube, that rotates the panels. The torque tube provides stiffness to resist wind forces, and some trackers also have torsional dampers that look like automotive shock absorbers to reduce vibration. Most single-axis trackers are mounted so that the axis of rotation is horizontal to the ground. The torque tube is supported by vertical piers or posts at intervals along its span that are mounted to the ground.

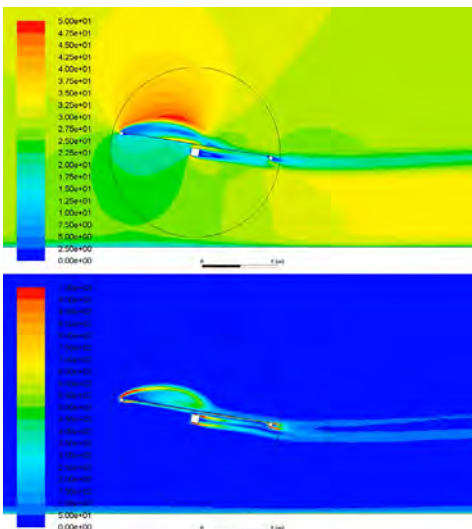

A vortex forms along the upper side of the panel during the simulation at 0.30 seconds.

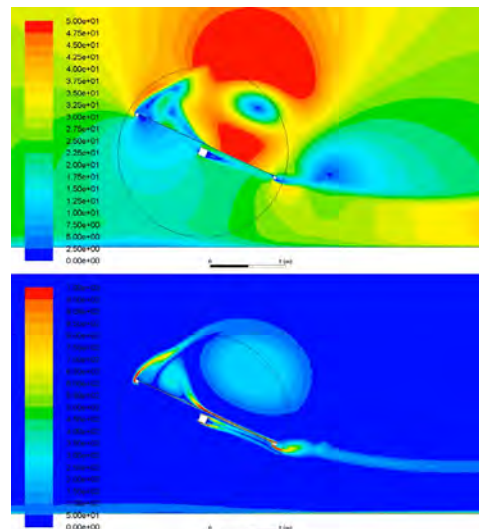

At 0.55 seconds, a vortex separates from the panel, and upward moment drops to zero.



When winds are high, trackers are often rotated into a stow position. Traditionally, this stow position places the panels parallel to the ground to reduce horizontal wind forces. In a series of incidents, trackers from multiple suppliers stowed in this manner have experienced large deflections in their first mode of vibration, a helical twisting mode with opposite ends of the solar panel rotating in opposite directions. Reports from the field indicate that the panels were oscillating more than 20 degrees in the positive and negative directions, causing damage.

In the flat stow position (parallel to the ground), the trackers bear a resemblance to an airplane wing, so CPP engineers postulated that their instability might be caused by flutter, which occurs when aerodynamic response amplifies the vibration of blades. Calculations with handbook equations indicated that classical flutter was not likely because the trackers cannot heave up and down while twisting because vertical motion is constrained at regular intervals by the support posts. Furthermore, handbook equations could not supply adequate results because they rely on assumptions that were not true for field conditions. For example, most of the handbook equations pertaining to flutter are based on oscillations that are much smaller than what was reported in the field with the solar trackers.

Neither CFD nor wind tunnel testing alone can provide a complete understanding of these phenomena. Aeroelastic wind tunnel testing does not reveal the flow mechanism that causes the instability, and the geometries and conditions that can be tested in this way are limited. CFD is well-suited to simulating many different design points and virtually any geometry or condition but requires validation comparison to physical testing when applied to a new problem. CFD also provides a deeper dive into the physics than can be obtained with wind tunnel testing, providing full-field pressure and velocity patterns that reveal the flow structures responsible for the tracker's motion.

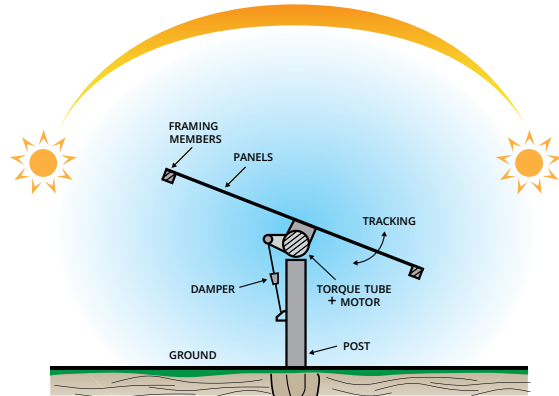

Typical solar tracker configuration

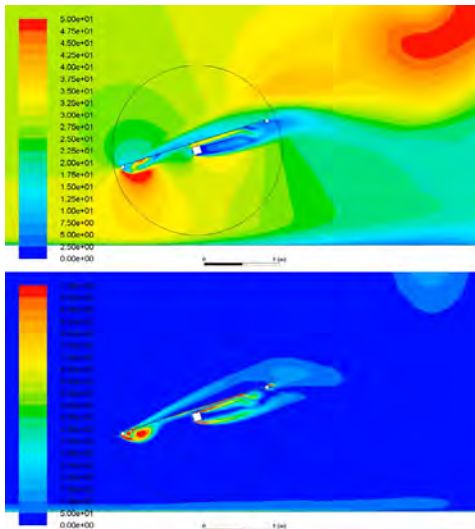

At 0.77 seconds, the leading edge of the tracker's panel has rotated downward and a vortex has formed on the lower edge.

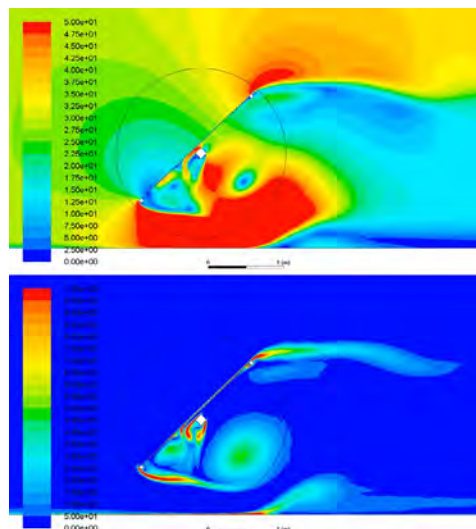

At 0.90 seconds, a vortex has separated and the leading edge is about to rotate upward.



**CFD MODELING OF A SECTION**

CPP engineers wanted to evaluate many different design points in order to tell their clients which were stable and which were unstable. To obtain short solution times, they used a 2D CFD model. While this model was not able to reproduce the 3D twisting seen in real solar trackers, CPP engineers calibrated the stiffness and damping of the 2D model to match the behavior of real 3D trackers as observed in the wind tunnel and in the field.

In the CFD model, the panel was mounted just barely high enough above the ground to spin without contacting the ground. The domain was meshed with approximately half a million quadrilateral cells with refinement around the panel and wake regions. Engineers applied the realizable  $k-\epsilon$  turbulence model to observe the threshold at which instability occurs. They ran a 10-second transient simulation with minimal computing resources to determine the stability of the tracker.

Engineers substantially reduced the computational effort required to perform the simulation by embedding the equations of motion for this model into a user-defined function (UDF), and using the UDF to calculate the deflection of the structure at each time step in the simulation. This information feeds back to the CFD solver, which adjusts a rotating mesh to alter the position of the tracker to account for the deflection. This approach provided reasonable results quickly.

Engineers created a table of design points in ANSYS Workbench by varying the windspeed, wind direction, elevation angle, structural stiffness and damping of the tracker. They then entered values in the table of the design parameters that they were interested in exploring. Next, engineers used Workbench to automatically generate models and execute CFD simulations to evaluate each of the design points and store the results.

**WIND TUNNEL TESTING VALIDATES SIMULATION**

At the same time, engineers built a physical section model that matched the geometry of the 2D CFD model and used a variable stiffness torsional spring to match the stiffness and damping of the CFD



model. The physical model was placed horizontally in CPP's atmospheric boundary layer wind tunnel. The spring was attached to the axis of rotation, and angular displacement was measured with a laser sensor. The wind tunnel model showed good agreement with the CFD results, providing assurance that the CFD model could be used to accurately evaluate alternative designs.

Next, the engineers built a 3D CFD model to run steady-state simulations of several key design points, allowing them to check whether the behavior of these points matched 2D CFD. They also built a fully three-dimensional aeroelastic wind tunnel model to further validate both the 2D and the 3D CFD models. All of these simulations and tests correlated well with each other.



Model used for wind tunnel testing

**NATURAL VENTILATION STRATEGIES**

The complementary benefits of wind tunnel testing and CFD have also been used by CPP engineers on several occasions to improve comfort levels in interior locations. Although wind tunnel testing is the most appropriate tool for accurately measuring wind speeds and turbulence in urban environments, it is primarily limited by Reynolds number effects to outdoor spaces. CPP engineers used a combination of wind tunnel pressure measurements and CFD studies of internal spaces to determine comfort levels in interior locations not accessible to wind tunnel testing. The computational models also enabled evaluation of thermal loads generated by occupants, equipment and solar heating that cannot be measured in the tunnel.

## WIND-DRIVEN RAIN

CPP engineers also synergistically combined CFD with wind tunnel testing to determine the extent of wet patches under awnings and close to building entries. They used both discrete particle models and Eulerian multiphase strategies in ANSYS Fluent and matched the predicted flow field against concurrent pedestrian-level wind tunnel testing to validate or scale the CFD results.

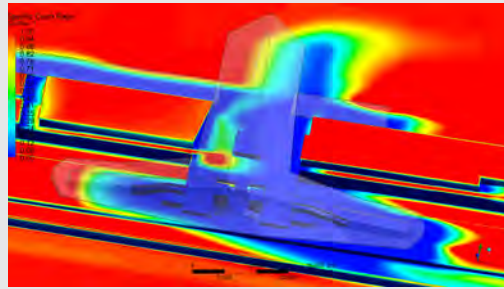

CFD results for wind-driven rain

## IDENTIFYING THE CAUSE OF THE INSTABILITY

The simulation showed that, in flat stow, a vortex forms above the leading edge of the tracker, creating a substantial moment across the central chord. This causes the tracker to twist and, as it does, the size of the flow separation increases and the zone of significant uplift crosses the midpoint of the chord. As the vortex is shed by the tracker, the moment suddenly drops to zero. The tracker then bounces back past the flat position so that its leading edge is twisted downward into the wind. A vortex then forms on the underside of the leading edge, and the process described above is repeated. The simulations showed that this instability is based on torsional divergence, and is not easily treated with damping.

Simulation showed that it is possible to excite twisting in the first mode shape with only a fraction of the full span participating in the vortex shedding, and that significant amplitudes can be reached in just a few cycles. Simulations were run at different conditions, and the time series was examined to determine whether the tracker was stable or unstable.

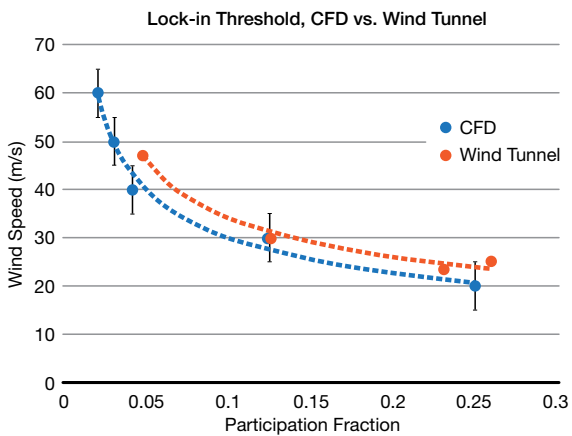

### ◀ Critical wind speed determined by simulation vs. wind tunnel testing

with maps of tracker angles, wind speeds and directions that indicate which types of trackers work under which weather and operating conditions. They also provided guidance on what results could be expected by upgrading the stiffness and damping of trackers. This project provides a good example of how CFD and wind tunnel testing can be combined to solve problems that would have been difficult or impossible to solve with either testing or simulation alone. Wind tunnel testing was also used to validate both 2D and 3D CFD models. CFD, on the other hand, made it possible to identify the exact cause and solve the problem. Engineers were able to evaluate many different design points in a reasonable amount of time while providing voluminous diagnostic information on each point. ⚠

CPP Wind is supported by ANSYS Channel  
Partner LEAP Australia.

Simulating the tracker over a wide range of conditions showed that the system has a critical velocity above which instability will always occur. The results revealed that, in many cases, instability could be avoided by stowing the trackers at an angle rather than parallel to the ground. However, the results also showed that tilting the tracker introduces the potential for vortex lock-in instability (where alternating vortices are shed from the leeward face of the tracker). Greater static loads and greater dynamic excitation due to buffeting also result from higher tilt stow. These issues can be addressed by increasing the stiffness and damping of the tracker.

CPP engineers provided their clients

# Less Pain to Predict Strain



By **Nathan Marks**  
Sr. Mechanical Engineer  
Applied Technology  
Cummins Power Systems  
Fridley, USA

◀ An initial skid assembly tested by Cummins

## Cummins provides generator sets to support the global demand for

reliable electricity in backup and remote

installations. Vibrations from large generator equipment can steadily weaken its supporting structures over time, which is often characterized by fatigue analysis. However, pure analytical models of the strain history on the metal frame are not accurate enough for fatigue prediction.

The challenge is to achieve good experimental correlation. The Cummins Power Systems team developed a new spin on a decades-old challenge of generator set durability modeling by integrating True-Load's strain correlation models

with overall structural analysis in ANSYS Mechanical to rev up its simulation workflow.



Direct Modeling Solutions for Reducing Model Setup Time and Driving Product Optimization  
[ansys.com/direct-modeling](https://ansys.com/direct-modeling)



How long will it last? This question about a product's useful lifespan before it needs to be repaired or replaced is pertinent for almost every tool, component or system. But, when the equipment supplies off-grid electricity for large-scale continuous or backup power for hospitals, water treatment centers, data centers or military units, organizations must be confident in the durability of the generator sets (gensets) that supply that power.

The size of the gensets required to meet electricity demands in the absence of grid power often means that they are isolated in a room. Repairing them might require taking the room apart at great cost. A genset's components, including the engine, crankshaft, generator, fans and radiators, are mounted on a metal frame that is known as a skid. Loading from the engine vibrations causes fatigue in the frame structure and connecting welds, which is the skid's primary failure mode of concern. For engineers at Cummins Power Systems, increasingly accurate prediction of the fatigue life of a skid based on a genset's actual operating conditions was desired.

### A NON-TRADITIONAL APPROACH

Previously, the process used by the Cummins team was to develop an analytical modal model of the structure and perform an experimental survey using accelerometers under operating conditions. The engineers used these measurements to determine an overall modal scaling factor for each mode.

Looking at each mode separately, the results from ANSYS Mechanical would be scaled by this factor to review the stress and strain predictions. It was not possible to look at the summed modal response with this method.

The team knew they needed a better process, because they were spending a lot of time and effort fixing problems that did not exist. Fatigue prediction is a log-log phenomenon, so an error of 15 to 20 percent in the strain history could result in a 200 percent error in the life model. It would thus be important to consider the complete participation of all the modes and to leverage industry standard tools for fatigue analysis. However, developing a better correlated strain history was paramount.

Cummins needed insight about where to place strain gauges on the skid to capture the right test data to correlate a model for the fatigue analysis. By adding the True-Load software package from Wolf Star Technologies into the simulation workflow with ANSYS SpaceClaim Direct Modeler and ANSYS Mechanical, the engineers were able to greatly improve speed and accuracy of skid durability modeling.

Beginning with an imported CAD geometry of the skid, the team deployed the defeaturing capabilities of the SpaceClaim technology to remove small gaps and faces that would not be important to the structural simulation. This reduced the overall mesh complexity. The mesh for the genset assembly model contained about 4 million elements. Using the model assembly function in the latest version of ANSYS Mechanical, the team was able to build the mesh three times faster than it would take to build a single model in the previous workflow. This model had much higher fidelity than any of the previous generations, largely due to the capabilities of SpaceClaim and Mechanical.

The structural simulation in Mechanical focused on a modal analysis, that is, determining the frequencies and shapes of the modes that are characteristic of the structure based on the



Natural gas genset in Cummins testing facility. The gas combustion engine, alternator, cooling system and control system are all mounted on top of a metal support frame, or skid.

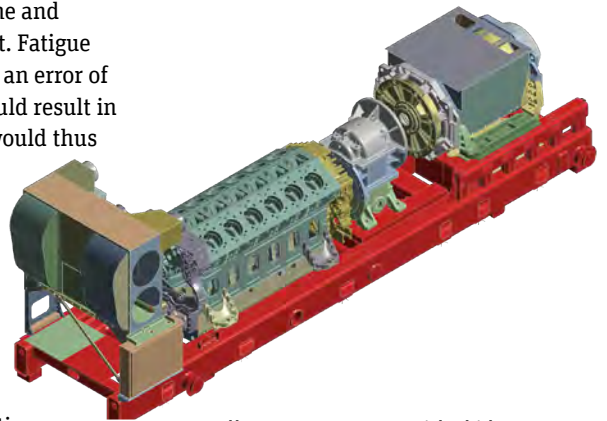
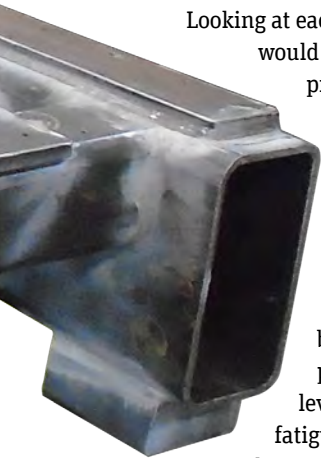

Full genset geometry with skid components shown in red in ANSYS Mechanical

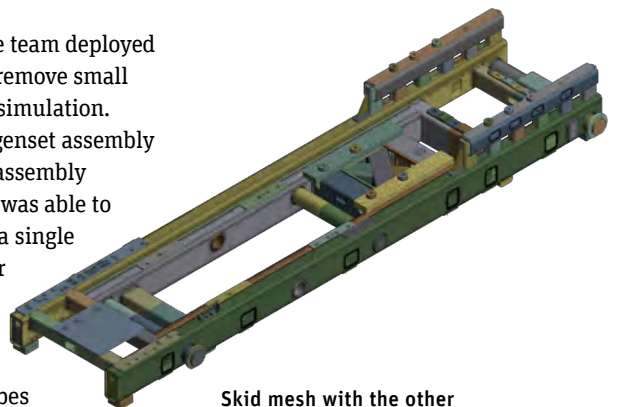

Skid mesh with the other genset structures removed

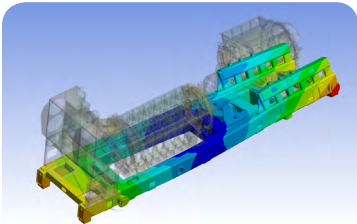
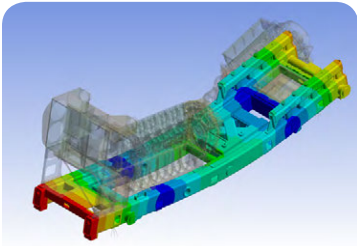

ANSYS Mechanical results showing the first and second modes of the vibration frequency modal analysis for the skid, representing vertical bending (top) and twisting mode shapes (bottom)

forcing functions that come from the engine vibrations. The team needed to understand both the total number of modes and the dominant modes that would determine the overall dynamic response. These modal excitations are what produce the stresses and strains on the skid, which is important for the downstream fatigue analysis. Using Mechanical’s parallel computing capabilities with a 16-core desktop workstation, the time to solution was accelerated by a factor of 3 to 10, depending on the analysis settings and complexity of the mesh. The computational speedup was enabled, in part, by creating the bonded contact definitions in a way to allow the model to solve more efficiently. The result of the modal analysis was 24 modes that the team could use as unit loads for use with True-Load.

**CORRELATING THE STRAIN HISTORY**

From the Mechanical solution, the Cummins team brought the results file with the modal analysis into True-Load. Using True-Load/Pre-Test, the engineers obtained guidance for the best places on the skid structure to lay physical strain gauges for experimental testing. The team found that a major benefit of True-Load/Pre-Test was that they avoided laying gauges in the wrong places and thereby getting unreliable data.

Generally, the guidance for experimental testing is that about one and a half to two gauges are needed for each unit load or mode. True-Load uses the deflected shapes from the Mechanical model. These shapes can be caused by static loads or eigen modes. In general, True-Load allows for the mixing of constraint modes (unit displacements), attachment modes (unit forces) and eigen modes (flexible modes).

The testing team was interested in 24 modes, which led them to use about 40 to 50 gauges for the skid. True-Load provided the team with the gauge locations by identifying the primary load paths for the structure based on the provided unit loads. With traditional techniques, a gauge may have been placed at what experience told the team was a relative hot spot, such as a weld, pin or notch. Using this new approach, True-Load instead guided them to place it at a more appropriate location for later use in the strain correlation.

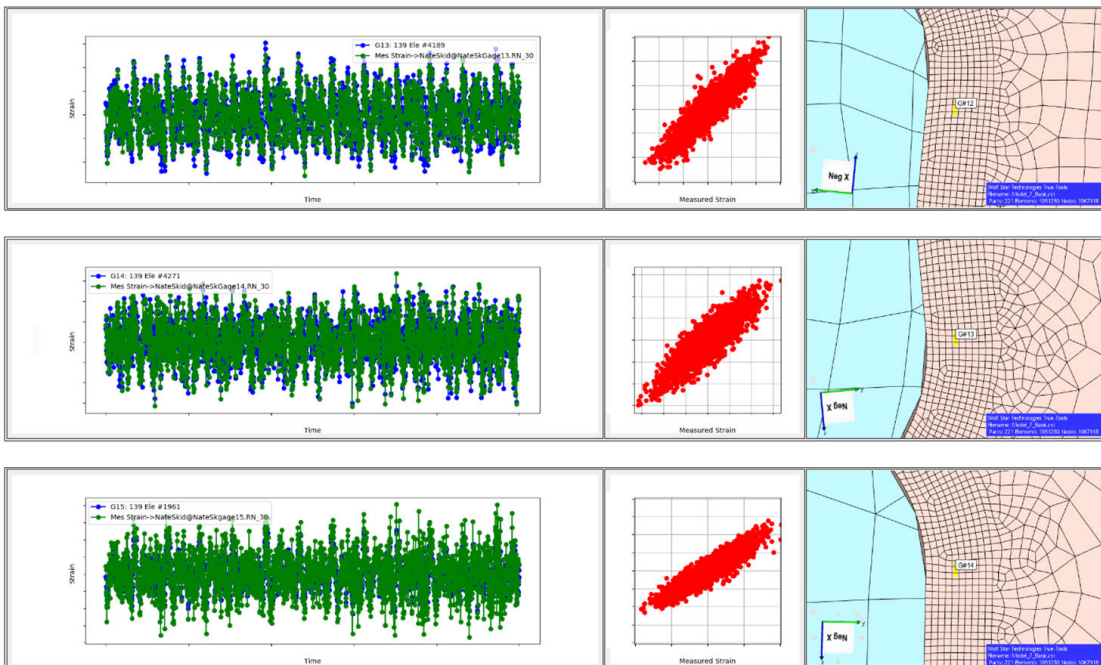

Left: Time history of measured strain data (green) compared to strain predictions using True-Load modal participation functions (blue). Right: Correlation graphs showing the strain predictions plotted against the measured data at three representative gauge locations for a test run. Perfect correlation would be a straight line with a slope of 1.

With the gauge locations in hand, the Cummins experimentalists collected data running the genset engine at speeds ranging from 1,350 to 1,650 rpm in one-minute intervals, including starting and stopping. At a high sampling rate, the team amassed a tremendous amount of data. This was not an issue since True-Load had no limit on the size of the data set and Cummins had plenty of hardware capacity to perform the correlation analysis. Using the experimental data with the unit loads from the Mechanical solution, True-Load/Post-Test calculated the modal participation functions. This produced the right combination of modes to correlate the simulated results to the measured strain data with an average error of about 6 percent (normalized root-mean-square). From there, the engineers took the True-Load load scale factors combined with the stress predictions from Mechanical and fed them into a fatigue analysis tool to generate the life contours for the skid.

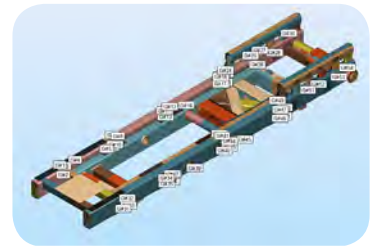

Recommended locations for 54 strain gauges from True-Load/Pre-Test based on the modal analysis data

Range of Amplitude for Each Mode

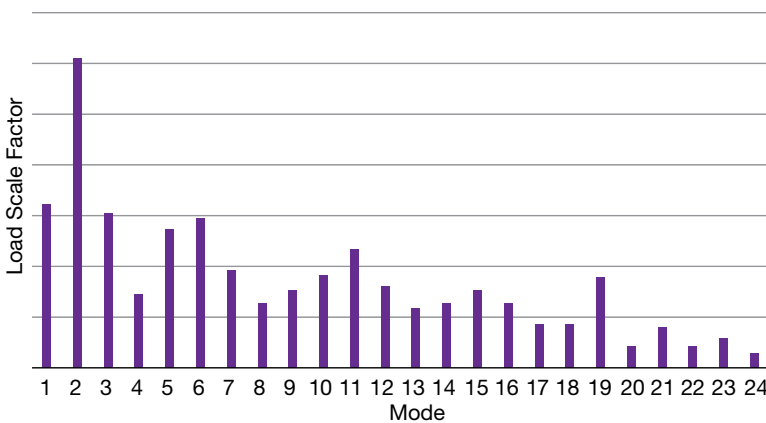

Modal participation functions calculated by True-Load/Post-Test define how much each mode is contributing to the total response. The graph shows that the amplitude range decreases as the modes and frequency increase, which should be the case.

### RESULTS AND PROCESS IMPROVEMENTS

The fatigue predictions showed that no damage to the skid would result from the specified duty cycle, which theoretically results in an infinite life for the structure. The team found that subsequent redesigns to reduce the skid’s weight did not appreciably change the predicted mode shapes and frequencies for the first few modes in Mechanical. Since the first few modes were the most significant contributions to the total response, the loading functions of the tested design could then be used as an approximation to evaluate the redesign in True-Load and the fatigue software package.

Because the full-field strain results could be extracted from relatively few discrete measurement locations, the Cummins engineers found this to be a huge value-add through both reduced development and testing time and overall reduced part cost by eliminating overdesign. Furthermore, in comparison to the traditional approach, the new process has promoted additional collaboration between the analytic and experimental groups as part of a straightforward end-to-end workflow for fatigue evaluation. Due to the significant design and analysis process speedup, the team plans to use the new approach in the future for other genset structures where the modal response is of interest, including the fans, radiators, shrouds and crankshafts. <sup>A</sup>

**“Using the model assembly function in the latest version of ANSYS Mechanical, the team was able to build the mesh three times faster than it would take to build a single model in the previous workflow.”**

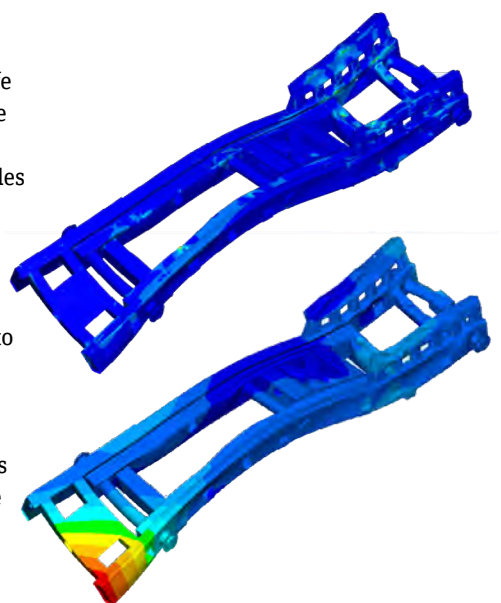

True-Load results showing first principal strain (top) and total displacement (bottom) over the entire skid at the same instant in time





# FAIL-SAFE DIGITAL



**Configurable safety relays** help to prevent injuries and damage in factory automation systems by cutting off electrical power in response to data received from sensors. When a safety relay fails, the production line must be halted until the relay can be repaired or replaced, resulting in expensive downtime. Phoenix Contact Electronics engineers used ANSYS software to develop a digital twin of its safety relays that will integrate real-time sensor data with simulation results to predict failures in advance. The relay can then be replaced or repaired while the line is not operating.

By **Ralf Hoffmann**, Senior Consulting Engineer, Phoenix Contact Electronics GmbH, Berlin, Germany

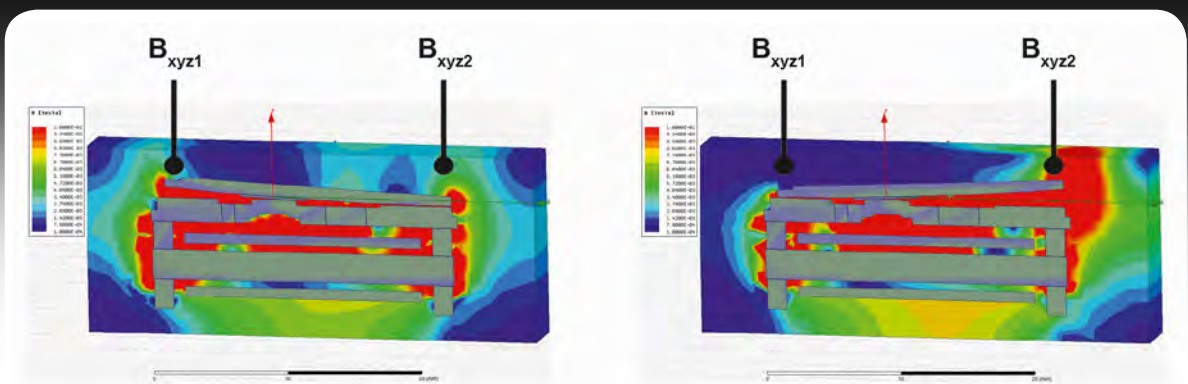

ANSYS Maxwell simulation shows magnetic field at different armature positions.

# “Phoenix Contact Electronics engineers use ANSYS Twin Builder to create a digital twin to accurately predict the remaining life of each relay.”

The remaining lifetime of a safety relay can be predicted empirically based on physical measurements in a laboratory on a specially instrumented relay. But when operating in real applications, relays cannot be instrumented to that level, in part because they must be sealed to protect them from often harsh factory environments. Phoenix Contact

Electronics engineers used a precursor version of ANSYS Twin Builder systems design software to integrate the limited measurements that can be performed on operating relays with reduced-order models (ROMs) of ANSYS multiphysics simulations to provide the data required for remaining lifetime predictions. Two different types of ROMs are integrated into the digital twin – ROMs that represent electromagnetic and mechanical behaviors of the relay and ROMs that are surrogate models for how input variability will affect result variability. The latter ROM, also known as a data-based ROM, was generated with ANSYS optiSLang’s metamodel of optimal prognosis (MOP) workflow to predict contact erosion and armature rotation angle before shutdown. Phoenix Contact Electronics has validated the digital twin on a special demonstrator relay and is now working to integrate the digital twin into relays used in real-world applications.

## RELAY LIFETIME TRADE-OFFS

In service, each safety relay encounters a unique history of load and environmental conditions that have a major impact on its longevity. Estimates of relay lifetime are based on worst-case scenarios to minimize downtime, so most relays are replaced long before the end of their lifetime. Despite this, the relays that

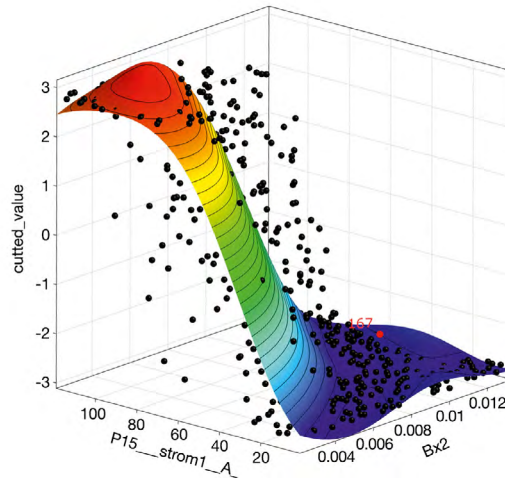

Metamodel of optimal prognosis predicts the armature position.

are subject to the most challenging loads and environmental conditions often fail for a number of reasons, the most common being contact abrasion.

Redundant arrangements and other internal safety functions usually shut down or bypass the relay in the event of a failure. Nevertheless, a failure

often makes it necessary to shut down the equipment controlled by the relay until the relay is fixed or replaced. Production lines controlled by relays often produce tens of thousands of dollars’ worth of product every hour, so even a short shutdown can be expensive. Until now there has been no practical way to predict an impending failure in a safety relay so that it can be replaced before failure during a period when the equipment it protects is not scheduled to operate.

The mechanical characteristics of relays are typically measured in laboratories on open relays. However, in actual usage, relays are normally encapsulated to survive harsh operating conditions. This encapsulation prevents determination of important mechanical characteristics such as the armature rotation angle. This angle has a major impact on the magnetic flux density, which is an important element in the life calculation. Another parameter that cannot be measured on a sealed operating relay is the contact bouncing time: the amount of time that the contacts vibrate against each other when the relay



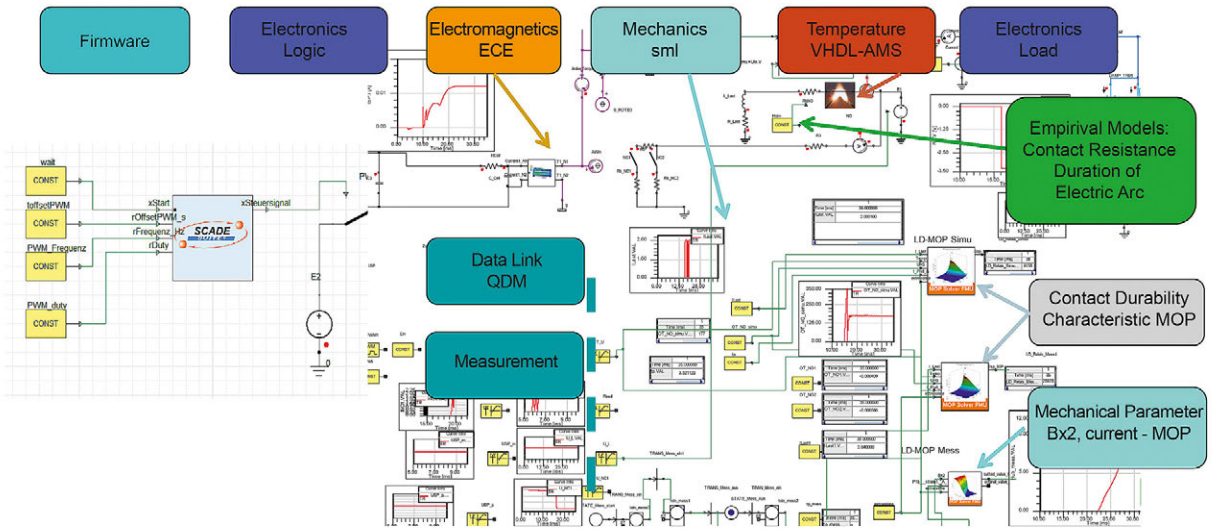

Schematic of the digital twin

closes before they settle into a stationary position. Contact bouncing has a major effect on the wear experienced by the contacts on each closure.

**CREATING A DIGITAL TWIN OF THE RELAY**

Phoenix Contact Electronics engineers use ANSYS Twin Builder software to create a digital twin, which integrates simulation results with physical measurements from the relay (and other components) to accurately predict the remaining life of each relay. This will enable factories to operate relays over nearly their full lifetime while minimizing failures and downtime.

The mechanical operation of the relay is simulated with static and transient ANSYS Mechanical finite element models. These simulations determine the motion, operating forces and stress conditions of the springs, transmission elements and other mechanical components. Full system simulation models for the relevant physics require a considerable amount of time to solve, so these models are converted to ROMs that preserve nearly all the accuracy of the original simulation model while providing results in a fraction of the time. ANSYS Twin Builder transforms the transient model into a ROM by dividing the model into individual linear parts, connecting them with coupling elements and transforming the natural modes into space-state matrices.

**SIMULATING ELECTROMAGNETIC PERFORMANCE**

Phoenix Contact engineers employ ANSYS Maxwell software to simulate the electromagnetic performance of the relay. Using co-simulation to couple the mechanical and electromagnetic models would have been computationally intensive, so engineers leveraged ANSYS Twin Builder to incorporate the torques and loads calculated by ANSYS Maxwell into a characteristic diagram to provide input to the mechanical simulation as a function of the rotation angle, stroke and electrical excitation, among other factors.

The effects of ambient temperature on internal temperatures in the relay are determined by analytical formulas in combination with empirical studies. These thermal correlations are incorporated into the digital twin using numerical

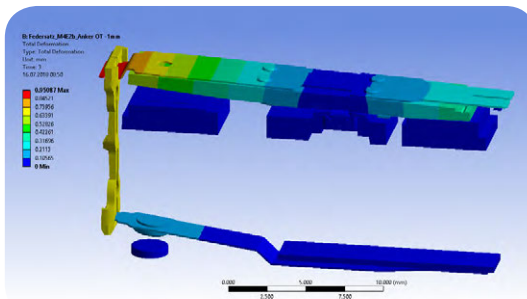

Static structural analysis of the contact spring

blocks. Handbook formulas are employed to derive some electrical characteristics, such as the contact resistance, as a function of the mechanical state of the system. The firmware used in the relay is developed with ANSYS SCADE and incorporated into the digital twin as a functional mock-up unit (FMU).

Two important components of the relay lifetime forecast cannot currently be measured in the field directly or forecast by simulation: the status of contact erosion and the position of the armature rotation angle before shutdown. The contact



erosion of the relays was measured under laboratory conditions for different load ranges, temperatures, operating voltages and installation types. Based on these measurements, an MOP was generated in ANSYS optiSLang to represent the contact lifetime as a function of relay operating parameters. From measurements of the magnetic field, the armature rotation angle can be identified. By scanning the whole range of possible orientations under laboratory conditions, an additional MOP was generated to predict the armature rotation angle in the digital twin based on sensor data of the magnetic field.

### **CALCULATING CONTACT BOUNCING**

The contact bouncing time depends on the speed of the armature and spring, contact force, contact gap and excitation voltage. Physical measurements of the actual relay update the simulation model, which calculates the bouncing. The results of the simulation in turn update the MOP that predicts the remaining lifetime of the relay. The importance of bouncing is shown by a simulation for one set of operating parameters, where a bouncing time of 1.592 milliseconds yielded a remaining lifetime of

292 switches to failure. By reducing bouncing time to 0.826 milliseconds, the remaining lifetime was increased to 29,343 switches to failure.

At present, Phoenix Contact Electronics is operating the digital twin with a demonstrator relay via a quality data model (QDM) structured data interface. On-demand, sensor readings such as temperature and voltage from the relay are transmitted to the digital twin and used to simulate the relay behavior. The simulation outputs along with measurement values are used as inputs to the MOP, which predicts the relay's remaining life.

Phoenix Contact Electronics has developed a digital twin methodology with the ability to accurately predict the remaining life of the demonstrator relay. Engineers are now working on integrating digital twins into production relays that will eventually provide accurate estimates of their remaining lifetime. These digital twins will enable manufacturers to use relays for their full lifetime while preventing failures and resulting downtime. 

*This article was based on "Metamodels in a Cyber-Physical System," first published in RDO Journal, Issue 2, 2017.*

## **SIMULATION IN THE NEWS**

### **ANSYS Acquires Material Intelligence Leader Granta Design**

*3D Printing Industry, January 2019*

The acquisition of Granta Design, the premier provider of materials information technology, expands ANSYS' portfolio into this important area, giving customers access to material intelligence, including data that is critical to successful simulations.

With advances in the performance of metals, plastics, ceramics and other materials, including innovations in areas such as composites and additive manufacturing, manufacturers have a wealth of material choices when developing products. At the same time, they require accurate, traceable and reliable materials information to make smart materials choices and to ensure simulation accuracy. With this acquisition, ANSYS customers can benefit from access to the world's premier system for managing corporate material intelligence and the market-leading solution for materials sources, selection and management. Granta customers can expect even easier access to ANSYS' simulation technology.

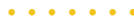

### **ANSYS Buys Electromagnetic Simulation Specialist, Helic**

*EE News Europe, January 2019*

The acquisition of Helic, the industry-leading provider of electromagnetic crosstalk solutions for systems on chips (SoCs), combined with ANSYS' flagship electromagnetic and semiconductor solvers, will provide a comprehensive solution for on-chip, 3D integrated circuit and chip-package-system electromagnetics and noise analysis.

# Speeding

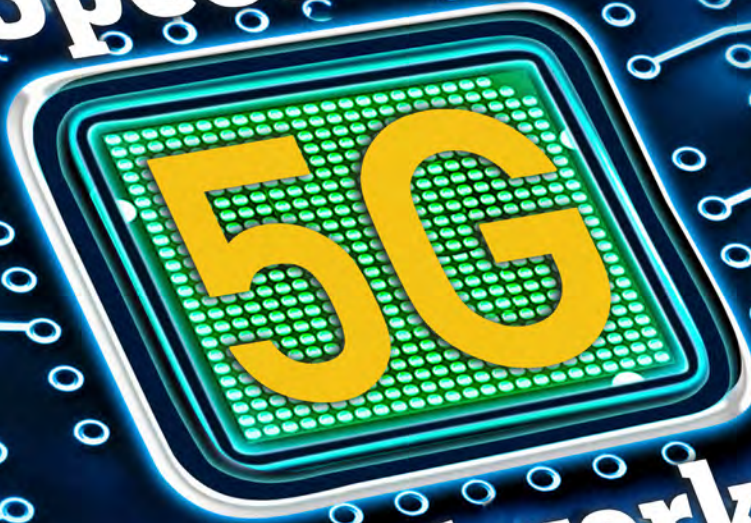

# Network Infrastructure Design

As the world becomes more connected and digital, the need for more data and higher speed is evident. The increase in global internet traffic, along with decentralization of cloud and data centers, has driven wired and wireless networks to support 5G network infrastructures. 5G technology promises to enable 1,000 times more traffic, 10 times faster speed and a 10 times increase in throughput. These systems are highly complex and push the boundaries of silicon and manufacturing technologies. eSilicon uses ANSYS' chip-package-system modeling and simulation software in a design-and-verification methodology that serves this ever-evolving market with timeliness and precision.

By **Teddy Lee**, Architect SI/PI, eSilicon Corporation, San Jose, USA



System-Level Chip-Package-System Power  
Integrity Co-Analysis Solutions for 3DICS  
[ansys.com/cps-solution-3dics](https://ansys.com/cps-solution-3dics)

**“With design costs in the tens of millions of dollars and re-spins resulting in schedule delays and missed market opportunities, eSilicon relies on ANSYS’ chip-package-system (CPS) modeling and simulation software.”**

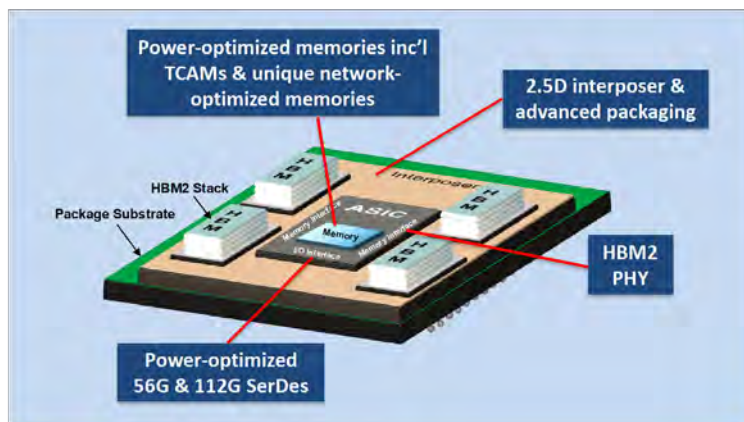

**Example of a hyperscale data center ASIC**

eSilicon’s highly configurable FinFET-class 7nm IP platform includes application-optimized processor core and a number of high-bandwidth memory (HBM) stacks integrated on a silicon interposer, built into a complex 2.5D package.

**W**hen designing at the bleeding edge of technology, companies require total system performance, not just chips working to specification. eSilicon addresses these needs with advanced application-specific integrated circuits (ASIC) and intellectual property (IP) for tier-one system original equipment manufacturers (OEMs) in 5G infrastructure, networking, high-performance computing and artificial intelligence markets. eSilicon delivers FinFET ASICs that integrate advanced IP developed by eSilicon at 14nm and 7nm as well as leading-edge 2.5D packaging. This allows the company to deliver lower-power, higher-bandwidth and more flexible products that meet the computational performance and system reliability requirements of customers. As both a developer and a user of advanced IP, eSilicon can deliver a more predictable and robust design.

The complexities associated with smaller semiconductor technology nodes, higher density and tighter margins do increase the risk for system failure during design bring-up or after the product has been out in the market for some time. With design costs in the tens of millions of dollars and re-spins resulting in schedule delays and missed market opportunities, eSilicon relies on ANSYS’ chip-package-system (CPS) modeling and simulation software, including ANSYS SIwave, RedHawk, HFSS and CMA, to test and validate their design before tapeout. ANSYS software models every component across chip, package, substrate and system at a very detailed level and provides an environment that seamlessly integrates each component into a single simulation. Verifying the full system from front to back, as early as possible, is critical to the company’s success. Design methodology that incorporates all the pieces (chip, memory, substrate, package) and ensures that the ASIC works by itself, as well as within the context of the entire system with other uncertainties, lowers risk and shortens time to market.

eSilicon engineers work closely with their customers to manage the complexity of their design and the interfaces. They pay careful attention to the effects of signal integrity (SI) and power integrity (PI) across the chip, package substrate, package and system. Partnering with ANSYS, they developed a CPS SI/PI modeling and analysis flow that models every component in a system from die to package to board in detail and simulates all of them together to better understand the impact each component has on the others.



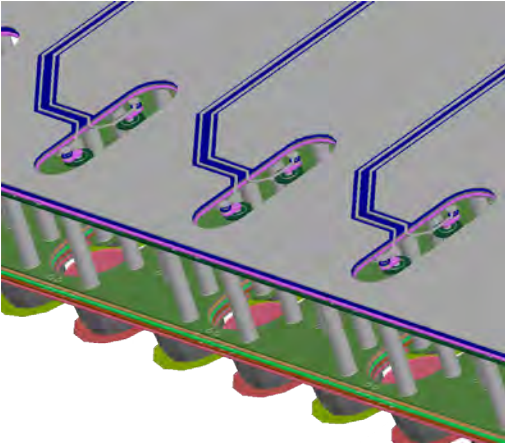

The antipads of the BGA region of the package substrate are enlarged and differentially bridged to reduce capacitance and boost impedance.

customers to use in an IBIS-AMI channel analysis to verify the transmitter and receiver performance in the time domain.

Material properties and geometric dimensions of passive interconnects in package substrates can affect the final S-parameter performance. For 2D designs, there are a number of field solvers that can calculate the impedance and SI performance, but the 2.5D packages designed by eSilicon engineers require ANSYS HFSS, a true 3D field solver for high-frequency SerDes designs. Inside a package or interposer with dense geometries, nearby structures can have a significant impact on signal performance, especially at high frequencies.

#### VERIFYING DC POWER INTEGRITY

For DC power integrity, eSilicon engineers model DC voltage drop from the voltage regulator module (VRM) on the board through the trace to the package substrate and silicon interposer. They use ANSYS SIwave to extract these components and combine them into a system model. They also use SIwave to run DC simulation for IR/voltage drop, current and power density verification. If any bottlenecks or violations are found, the engineers perform another iteration to improve the power distribution network. By using ANSYS tools with high-level accuracy, fast throughput and seamless integration, the engineers are able to improve their design, as well as run quick what-if analyses of design tweaks.

Having an accurate view of the board-to-die power routing, with detailed parasitic extractions at each level, is essential for reliable PI analysis. When engineers assume an idealized voltage regulator module (VRM) on the system board, the simulation results can significantly diverge from real-world performance because localized currents could exceed the average current for the voltage source. Therefore, it is important to define the exact location of the VRM and extract the real traces that will drive the package. By using SIwave, engineers are able to perform a fine-grained analysis of the power distribution network all the way from the VRM to the die ports.

#### VERIFYING AC POWER INTEGRITY

Managing the impact of noise generated by the die on the system is critical to design success. To have a comprehensive view of power integrity, it is important to understand how power is delivered through the silicon interposer, package substrate and board. eSilicon engineers employ CPS methodology by extracting and modeling each component starting from the die through the interposer, package substrate and PCB. They then simulate the whole system in frequency and time domains. Engineers use ANSYS RedHawk to model the die and interposer, ANSYS SIwave for the package and PCB analysis, and ANSYS CMA for simulation. One of the challenges in verifying the full system with fine-grain accuracy is the varying frequency range of components from VRM to chip.

#### VERIFYING SIGNAL INTEGRITY

As soon as initial layouts for the substrate and silicon interposer are available, eSilicon engineers extract complex 3D structures using ANSYS HFSS and ANSYS SIwave to generate S-parameter models for insertion loss, return loss and crosstalk performance analyses of high-speed nets. The frequency responses of passive elements are compared to the package specification. Any violations or insufficient margins will result in a design change with additional iterations of extraction and analysis until the requirements are met. For 2.5D package designs, eSilicon engineers connect the substrate and interposer S-parameter models to create a final package model. This model is delivered to the

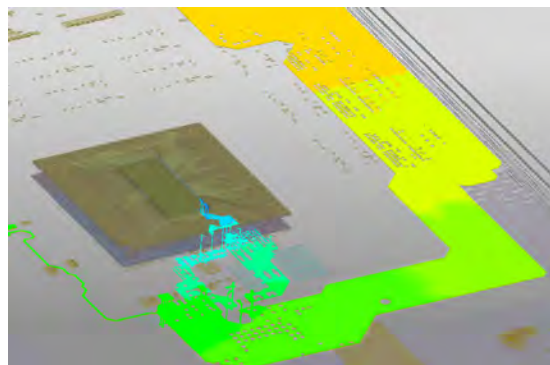

3D model of the voltage plot shows simulated voltage gradients from the VRM to the package, helping eSilicon engineers localize where the drop is happening, such as vias on the PCB, swiss-cheese planes underneath BGA and the package layers.

ANSYS CMA models the full power-delivery network current profile across a wide frequency spectrum of the chip, package and board. It can simulate the large current transients — from a few nanoseconds to milliseconds in duration — in the chip, package and board boundaries that lead to catastrophic global rail voltage collapse.

The goal of AC power integrity analysis is to ensure acceptable transient supply noise by optimizing impedance. If supply noise is too high or its margin is too low, the engineers will loop back to the frequency domain for more decap optimization, or even further back to the layout. By performing analysis early in the design phase, eSilicon engineers are able to optimize the performance instead of simply verifying it.

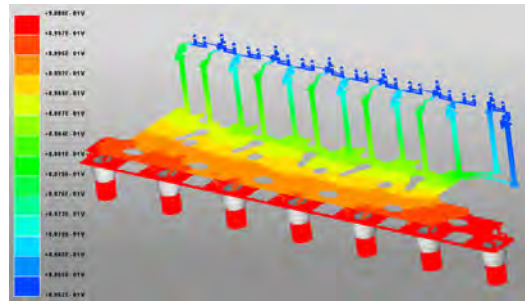

Simulated voltage gradient from package to chip interface, from BGA balls through substrate vias and finally to the traces leading to C4 interface. Since power distribution network in the package is smaller and denser than the PCB, there is less opportunity for significant IR drop improvement in package design.

### FREQUENCY DOMAIN SELF-IMPEDANCE AND CAPACITOR OPTIMIZATION

As part of the frequency-domain analysis, eSilicon engineers observe the self-impedance from the die and its effects on each component in the system. They need to determine if any package-level capacitors are needed to lower system-level resonance at the package. Using ANSYS SIwave, they calculate target impedance and detune the resonance frequencies by adding different capacitor values and quantities.

### TIME-DOMAIN SIMULATION

Once decaps are optimized in the frequency domain, eSilicon engineers perform time-domain simulation to analyze the power-supply noise at the die. They use ANSYS RedHawk to generate the current profile and extract an electrical model of the die's power delivery network. RedHawk is primarily a die-level tool, so simulation

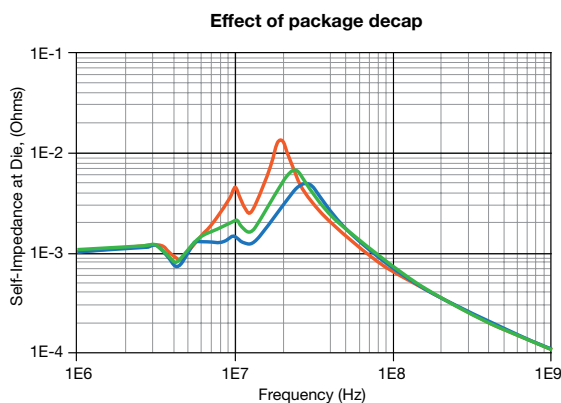

Observation of the effect of adding more 1 uF capacitors at the package level. Increase in quantity showed lower impedance at the parallel resonance. Once target impedance was reached, further optimization focused on effectiveness of mixes of capacitor values and quantities.

produces a current profile with high-frequency data but only for a very short duration. However, a longer period is required for the lower bandwidth in system-level analysis. Extending the current profile is not as simple as repeating the waveform, since current modulation is used to excite specific resonant frequencies or to model some functional mode such as TCAM memory access. ANSYS CMA allows eSilicon engineers to modulate the current profile to any envelope and output frequency domain impedance, as well as any time domain transient noise. In addition, ANSYS CMA automatically connects complex interfaces between the die, interposer and package, which saves a significant amount of manual effort and reduces the risk of error.

Once the extended and modulated current stimulus is available, eSilicon engineers analyze the entire power-distribution network using time-domain simulation with ANSYS CMA. They compare simulation results against the allowable noise specification to see if there are any violations. If additional margin is needed, the engineers will go back to frequency-domain simulation to further optimize the design by changing capacitance on the die, package or board; they may even go back further in the design process to optimize the layout of the power distribution network.

Once the extended and modulated current stimulus is available, eSilicon engineers analyze

eSilicon services tier-one system OEMs whose challenges go beyond lower power, higher performance and smaller size. They are concerned about lifetime performance, thermal and mechanical reliability, and integration with firmware and software. With the level of complexity involved in getting this scale of project to market, design and verification methodology around CPS flow using ANSYS' suite of tools helps eSilicon to accelerate time-to-profit. 📈

### References

- Multi-Die Packaging and Thermal Superposition Modeling, [info.esilicon.com/esilicon-white-paper-downloads-4?submissionGuid=c5150914-7c85-4e78-9668-aff0482d4345](https://info.esilicon.com/esilicon-white-paper-downloads-4?submissionGuid=c5150914-7c85-4e78-9668-aff0482d4345) (12/19/2018)
- 2.5D/HBM2 Packaging & Solutions, [esilicon.com/capabilities/custom-2-5d-3d-packaging/](https://esilicon.com/capabilities/custom-2-5d-3d-packaging/) (12/19/2018)





# Framing a Lighter, Stronger Race Car

By **Paolo Bosetti**  
Assistant Professor  
Department of Industrial Engineering  
University of Trento, Italy

Engineering student teams in universities around the world compete in the Formula SAE (FSAE) competition to build a race car, giving them an opportunity to apply their engineering knowledge in a practical and fun way. The E-AGLE Trento racing team takes advantage of ANSYS additive manufacturing solutions and topology optimization in ANSYS Mechanical to design a car that is lighter, has stronger joints and is easier to build than a typical FSAE car.

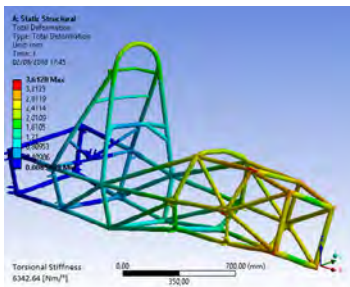

FSAE car frame with increased torsional stiffness due to 3D-printed joints

For the E-AGLE Trento racing team at the University of Trento, Italy, Formula SAE is not just about the race — it is also about implementing a groundbreaking idea for the design and manufacture of the vehicle frame. Working closely with the ANSYS technical support team, they performed simulations using ANSYS Workbench Additive (part of ANSYS Additive Suite) to produce an innovative frame joint that relies more on the mechanical properties of the materials and less on a potentially weaker weld for its strength. The joint also makes the manufacturing phase easier by minimizing the need for external dies or fixtures to hold components in place during the welding phase. Workbench Additive enabled the team to make a traditionally weak part of the frame — the so-called “hard point,” where the suspension is attached to the car frame — an integral part of the 3D-printed joint instead of consisting of a metal tab welded to the outside of



the joint. By eliminating this typically weak point, the team made the vehicle frame more rigid and less susceptible to breakage during a race. Finally, topology optimization using ANSYS Mechanical helped them to reduce the mass of one component of the car by 55 percent.

### ORIGINS

The E-AGLE Trento team was formed in 2016 under the direction of faculty from the University of Trento. Realizing that they would need to use additive manufacturing for some components of the race car they planned to build, the team partnered with the industrial development company Trentino Sviluppo, which is owned by the local government and funded by the EU, and its facility for prototyping mechatronics systems, named ProM. The latter is managed by Trentino Sviluppo SpA, the University of Trento and the Bruno Kessler Foundation, with some help from Confindustria Trento.

This partnership was a win-win arrangement. The E-AGLE Trento team needed to use ProM's 3D printers, laser cutters and other leading-edge equipment. ProM needed a first test case to demonstrate their capabilities to the market. The FSAE car project was an ideal test case.

### ENGINEERING THE BASICS

The team started with an open-frame design instead of the monocoque design used by many teams in the competition. The open-frame design focused the engineering challenge on designing the best configuration of metal tubes and joints. The overall goal was to determine the high-level geometry of the frame by optimizing a parameter defined as the torsional stiffness of the car frame divided by the weight of the frame.

With a wide range of variables possible for the diameters, thicknesses and relative positions of joints between three tubes in the car frame, student engineers performed parametric studies using ANSYS Mechanical within the ANSYS Workbench environment to investigate all the options. Finding the optimal cross sections and thicknesses of tubes at each point in the frame was critical to strengthening the frame at points of high stress while minimizing the total weight of the frame. Parametric simulation studies enabled the students to determine the optimum configuration of each tube and joint in a fraction of the time it would have taken them had they been limited to traditional manual iterations.

### GETTING DOWN TO DETAILS

E-AGLE Trento team engineers wanted to go beyond merely designing a satisfactory FSAE car frame — they aspired to introduce a revolutionary element that would greatly improve the strength and manufacturability of the vehicle. This innovative element would be the frame joint. This is the point at which three or more frame tubes intersect to form a corner. Traditionally, the tubes are simply welded end-to-end to form the joint, but welds can be weak points in a frame. Using ANSYS Mechanical and Workbench Additive, the engineers concentrated on making a frame joint whose strength depended more on the mechanical properties of the metal and less on the weld itself. They also incorporated the hard points of the suspension connections into the 3D-printed joint to eliminate another weakness.

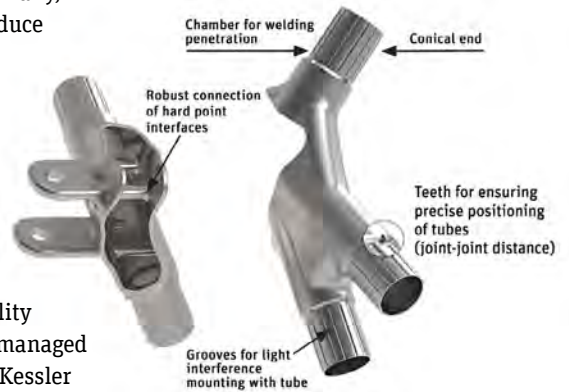

3D-printed joint for greater strength and torsional stiffness



Close-up view of an assembled car frame section showing a four-way joint with integral hard point connectors

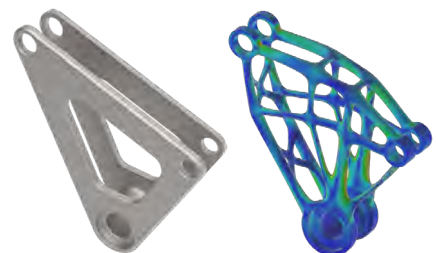

Original bellcrank

New bellcrank

Bellcrank designed using ANSYS topology optimization, which reduced the weight of the part from 345 g to 220 g, a decrease of 37 percent

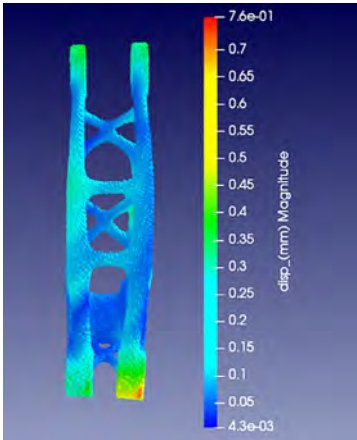

Simulated thermal distortion of FSAE car component

**“Using topology optimization, student engineers reduced the bellcrank’s mass from 345 g to 220 g, a 37 percent reduction.”**

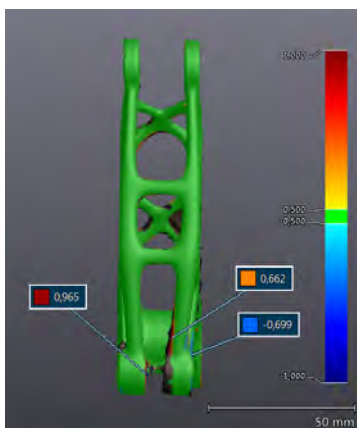

Measured thermal distortion of actual physical component

Having already determined the optimal frame tube dimensions, they used Workbench Additive to design the joint with a slightly larger diameter so that the joint ends would fit inside the tails of the frame tubes. The resulting inner joint has a set of longitudinal crests that are designed to contact with the outer frame tube. This ensures that the mechanical stresses between tubes and joints are mainly sustained by the mechanical fit of the joints in the tube rather than by the subsequent weld. The end of the frame tube has a slight chamfer to accommodate the welding alloy. Small, tooth-like protrusions spaced at regular intervals along this chamfer ensure the right distance between the tube and joint. This very precise relative positioning of tubes and joints has two big advantages:

- Only a single die is needed during assembly of the car frame. This single die helps join the main hoop of the car frame with the rear part of the vehicle during welding. FSAE regulations stipulate that the main hoop has to be one single tube, so it cannot be joined, only welded. Assembly of the rear part of the car frame requires no dies because the structure is fixed by precise positioning of tubes relative to joints. This arrangement enables welding precision and greatly reduces the welding time needed for the whole car frame.
- The resulting frame is much more robust and rigid when compared with a purely welded open-space frame design.

#### LIGHTWEIGHTING COMPONENTS

Reducing weight is an obvious way to make a car quicker in acceleration and able to go faster while consuming the same amount of fuel — critical to any race car. E-AGLE Trento engineers used topological optimization with ANSYS Mechanical to redesign three components that were initially made of solid metal: the bellcrank, the suspension rockers and the steering support mechanism. Topology optimization automatically determines where material should exist within a given volume so that loads and stresses can be efficiently managed when the part is loaded. The resulting framework has open spaces where no material is needed and thicker struts where stresses are high. Overall, topology optimization reduces the weight of each component. In this case, the student engineers reduced the bellcrank’s mass from 345 g to 220 g, a 37 percent reduction. For the steering support, they reduced the mass by 55 percent, from 450 g to 210 g.

#### COMPENSATING FOR THERMAL DEFORMATION IN ADDITIVE MANUFACTURING DESIGNS

Powder-bed metal additive manufacturing involves adding layers of material and heating them with a laser to fuse the powder. This heating and cooling can result in deformations, which will result in a non-ideal shape. The E-AGLE Trento team used ANSYS Workbench Additive to simulate the amount of thermal distortion before performing the 3D print run so they could adjust the geometry of the part to compensate for the distortion. While distortion still occurred, it happened in a predictable manner that was taken into account by the modified geometry. The resulting part met specifications exactly.

#### COOPERATION WINS THE RACE

By working closely with the ANSYS technical support team, E-AGLE Trento student engineers learned how to use Workbench Additive and Mechanical efficiently and effectively to design a groundbreaking frame design for their FSAE car. The car is lighter and stronger with increased torsional stiffness, which should lead to higher speeds, reduced wear and greater safety. 🏆

# Simulation in the News

## ANSYS 2019 R1 DELIVERS SPEED AND EASE OF USE FOR NEXT-GENERATION INNOVATIONS

MCADCafe, January 2018

The arrival of 5G, autonomous driving and electrification continues to spark unprecedented change across the product development landscape, requiring engineers to increase their speed of new concept ideation, simulation and validation, all without compromising power or accuracy. ANSYS 2019 R1 introduces new, portfolio-wide capability upgrades to support this increasingly rapid pace of innovation.

From a revolutionary user experience in ANSYS Fluent to the super-accurate additive manufacturing solutions and groundbreaking capabilities in the new ANSYS Motion product line, ANSYS 2019 R1 maximizes productivity across a multitude of industries.

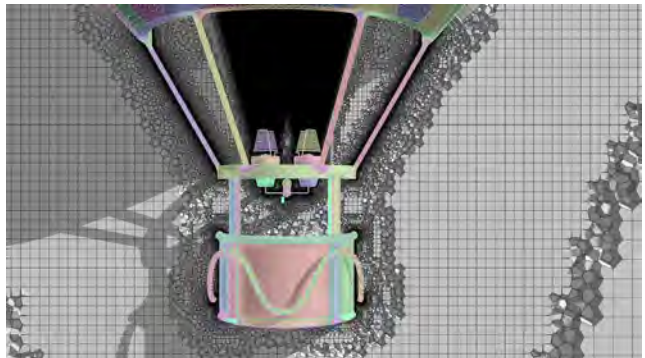

ANSYS Fluent's task-based workflow enables users to quickly and easily create high-quality Mosaic-enabled meshes, even for complex geometries.

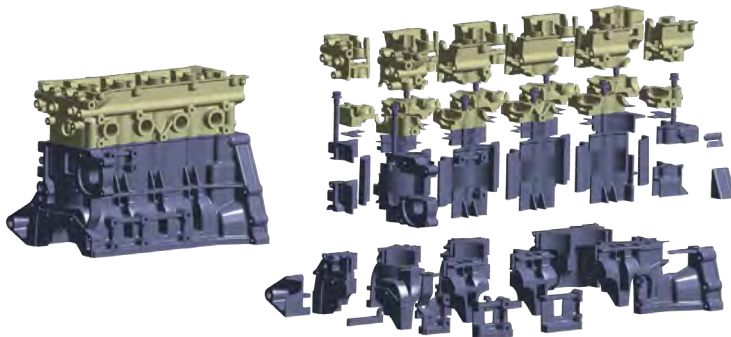

ANSYS Mechanical can run models with large contact areas up to two times faster.

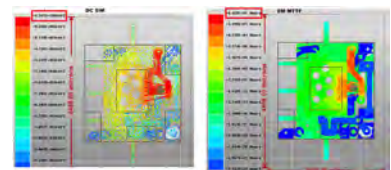

EMI Scanner in ANSYS HFSS and ANSYS SIwave enables design-rule checking to identify potential EMI issues in a design prior to full simulation.



ANSYS 2019 R1  
[ansys.com/r1](https://www.ansys.com/r1)

## ANSYS TEAMS WITH MICROSOFT TO ENABLE COMPLEX MODELING IN THE CLOUD

DE247, February 2019



Challenged by pressures to accelerate innovation, reduce time to market and overcome limited compute resources, engineers around the world can now leverage ANSYS Cloud, a new service teaming ANSYS Mechanical and ANSYS Fluent software with Microsoft Azure data centers and high-performance computing (HPC) infrastructure. ANSYS Cloud empowers engineers with seamless and secure access to on-demand HPC, boosting their productivity while saving valuable time and resources.

Featuring virtually unlimited compute capacity, ANSYS Cloud provides a robust and secure environment to run high-fidelity simulations in the cloud and evaluate more design variations in less time. This allows organizations to increase their simulation throughput to solve larger, more complex models instantly and effortlessly, significantly expediting new product development.



ANSYS Cloud  
[ansys.com/ansys-cloud](https://www.ansys.com/ansys-cloud)



ANSYS, Inc.  
Southpointe  
2600 ANSYS Drive  
Canonsburg, PA U.S.A. 15317

Send address corrections to  
[AdvantageAddressChange@ansys.com](mailto:AdvantageAddressChange@ansys.com)



# POWERING THE ELECTRIFICATION REVOLUTION

ANSYS SIMULATION ACCELERATES THE DESIGN AND DEVELOPMENT OF ELECTRIFIED SYSTEMS — FROM ELECTRIC CARS AND AIRCRAFT TO INDUSTRIAL EQUIPMENT AND POWER PLANTS — ACROSS ALL INDUSTRIES.

[ANSYS.COM/ELECTRIFICATION](https://www.ansys.com/electrification)

**ANSYS**<sup>®</sup>