

Innovation Through Pervasive Engineering Simulation

Investor Presentation

Q4 & FY 2020

NASDAQ: ANSS



Cautionary Statement Regarding Forward-Looking and Non-GAAP Financial Information

This presentation contains forward-looking statements within the meaning of the Private Securities Litigation Reform Act of 1995. Forward-looking statements are statements that provide current expectations or forecasts of future events based on certain assumptions. Forward-looking statements are subject to risks, uncertainties, and factors relating to our business which could cause our actual results to differ materially from the expectations expressed in or implied by such forward-looking statements. Many of these risks, uncertainties, and factors are currently amplified by, and may continue to be amplified by, the COVID-19 pandemic.

Forward-looking statements use words such as “anticipate,” “believe,” “could,” “estimate,” “expect,” “forecast,” “intend,” “likely,” “may,” “outlook,” “plan,” “predict,” “project,” “should,” “target,” or other words of similar meaning. Forward-looking statements include those about market opportunity, including our total addressable market. We caution readers not to place undue reliance upon any such forward-looking statements, which speak only as of the date they are made. We undertake no obligation to update forward-looking statements, whether as a result of new information, future events or otherwise.

The following risks, among others, could cause actual results to differ materially from those described in any forward-looking statements:

- current and potential future impacts of the COVID-19 pandemic on the global economy and our business, and consolidated financial statements; adverse changes in global economic and/or political conditions; and political, economic, regulatory and public health and safety risks and uncertainties in the countries and regions in which we operate;
- declines in our customers’ businesses resulting in adverse changes in procurement patterns; disruptions in accounts receivable and cash flow due to customers’ liquidity challenges and commercial deterioration; uncertainties regarding demand for our products and services in the future and our customers’ acceptance of new products; and delays or declines in anticipated sales due to reduced or altered sales and marketing interactions with customers;
- impacts from tariffs, trade sanctions, export license requirements or other trade barriers; disruptions in the global economy and financial markets that may limit or delay availability of credit under existing or new credit facilities, or that may limit our ability to obtain credit or financing on acceptable terms or at all; and the effect of changes in currency exchange rates or interest rates;
- our ability to protect our proprietary technology; cybersecurity threats or other security breaches, including in relation to an increased level of our activity that is occurring from remote global off-site locations; and disclosure and misuse of employee or customer data whether as a result of a cybersecurity incident or otherwise;
- the quality of our products, including the strength of features, functionality and integrated multi-physics capabilities; our ability to develop and market new products to address the industry’s rapidly changing technology; the failures or errors in our products and services; and increased pricing pressure as a result of the competitive environment in which we operate;
- plans for future capital spending; the extent of corporate benefits from such spending including with respect to customer relationship management; and higher than anticipated costs for research and development or slowdown in our research and development activities;

Cautionary Statement Regarding Forward-Looking and Non-GAAP Financial Information

- investments in complementary companies, products, services and technologies; our ability to complete and successfully integrate our acquisitions and realize the financial and business benefits of the transactions; and the impact indebtedness incurred in connection with any acquisition could have on our operations;
- investments in global sales and marketing organizations and global business infrastructure; and dependence on our channel partners for the distribution of our products;
- our ability to recruit and retain key personnel including any delays in recruitment caused by restrictions on travel and in person interactions; and the absence of key personnel or teams due to illness or recuperation;
- increased volatility in our revenue due to the timing, duration and value of multi-year lease contracts; our reliance on high renewal rates for annual lease and maintenance contracts; the volatility of our stock price; the potential variations in our sales forecasts compared to actual sales; and the uncertainty of estimates associated with the acquisition accounting treatment of deferred revenue;
- operational disruptions generally or specifically in connection with transitions to and from remote work environments; and the failure of our technological infrastructure or those of the service providers upon whom we rely including for infrastructure and cloud services;
- our and our channel partners' ability to comply with laws and regulations in relevant jurisdictions; the outcome of contingencies, including legal proceedings, government or regulatory investigations and service tax audit cases;
- uncertainty regarding income tax estimates in the jurisdictions in which we operate; and the effect of changes in tax laws and regulations in the jurisdictions in which we operate;
- and other risks and uncertainties described in our reports filed from time to time with the Securities and Exchange Commission.

We include non-GAAP financial information in this presentation. Reconciliations for such financial information may be found in our presentation, in these slides including in the Appendix, in other materials on our corporate website, and in our SEC filings. This information supplements our GAAP results and should not be viewed in isolation from, or as a substitute for, GAAP results. We believe that this information and the related reconciliations may be useful to investors, analysts and others to help understand and evaluate our financial results, and with respect to adjusted metrics, because we believe they better reflect the ongoing financial results and trends of our businesses and increase comparability of period-to-period results.

COVID-19 Update (as of February 24, 2021)

Information from 4Q & FY 2020 Earnings

Operational Impact

- The health and safety of our employees and their families, our partners and our broad Ansys community around the world continue to be a high priority. We are continuing to closely monitor the situation, but as of now remote access remains the primary means of work for a majority of our workforce. Additionally, we are operating under certain travel restrictions. These actions have disrupted how we operate the business.
- Our sales teams continue to close contracts, despite the purchasing process being slowed, particularly for customers with lower levels of remote working sophistication.
- Our R&D teams continued to be productive, meeting their product release targets, as evidenced by the recent release of Ansys 2021 R1. We expect to continue to maintain effective financial operations, systems and internal controls as we work remotely during the pandemic. In January, we hosted our annual sales conference virtually, a three-day event with over 2,000 attendees.

Financial Impact

- Despite the continued effects of COVID-19 on the business environment, the resilience of our business contributed to the delivery of ACV, revenue, operating margin, earnings and cash flow that exceeded the high end of our financial guidance.

Liquidity Impact

- Our cash and cash equivalents increased during the quarter, ending with a balance of \$912.7 million as of December 31, 2020. We believe that this balance, together with cash generated from operations and access to our \$500.0 million revolving credit facility, are in excess of the cash required for our ongoing operations over the next twelve months.
- Our cash flows from operations in Q4 and FY 2020 totaled \$173.8 million and \$547.3 million, respectively. The FY 2020 cash flow significantly exceeded our guidance range and was driven by strong customer receipts in Q4, including both the recovery of payments delayed from earlier in the year due to COVID-19, as well as the receipt of payments that were scheduled to be received in 2021. The growth was further aided by our ability to delay certain income, employment and indirect tax payments to 2021. While benefiting the FY 2020 results, the early receipt of customer payments and the deferral of tax payments into 2021 will adversely impact operating cash flow in 2021. Despite the strong Q4 cash flow, as the COVID-19 crisis lengthens, we continue to experience longer-term payment requests, primarily related to larger contract commitments.
- We have two unsecured term loans with an aggregate outstanding principal balance of \$800.0 million as of December 31, 2020. We are compliant with our debt covenants. Our debt agreements require no principal payments until 2022. Our only debt service requirements are interest payments in the current low-rate environment. We believe we will have adequate liquidity to service this debt over the next twelve months.

Well Positioned in a Growing Market

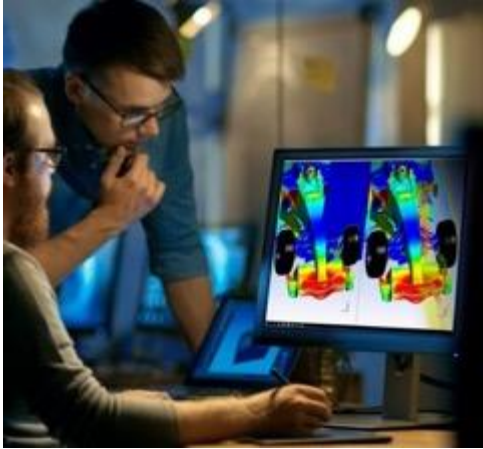

**ANSYS IS THE
SIMULATION
MARKET LEADER**

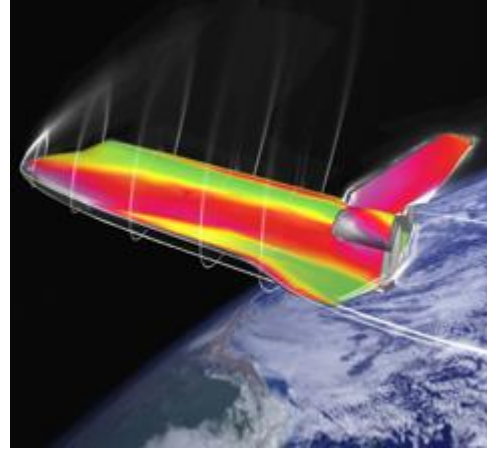

**THE SIMULATION
MARKET IS STRONG
AND GROWING**

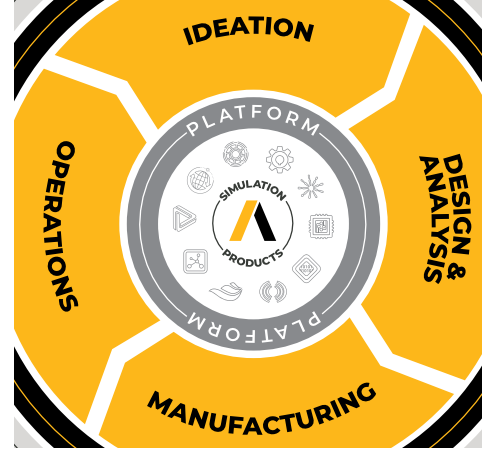

**OUR STRATEGY
CAPITALIZES ON
THIS GROWING
MARKET**



**WE HAVE A
PROVEN RECORD
OF EXECUTION**

A Leader in the Simulation Market for 50 Years

~2X THE SIZE OF OUR
NEAREST COMPETITOR

(CIMdata June 2020 Report)*

#1 IN
SIMULATION

FOCUSED
SIMULATION IS ALL WE DO

PROVEN

MEMBER OF PRESTIGIOUS

STANDARD
& POOR'S

Nasdaq
100 Index

\$32B market capitalization

(as of February 23, 2021)

COMMITTED

OVERALL CUSTOMER SATISFACTION
GLOBALLY (2020): 89%

CAPABLE

4,800 EMPLOYEES GLOBALLY

85 ANSYS OFFICES

>150 CHANNEL PARTNERS GLOBALLY

Commitment to Corporate Responsibility

People

ONE/Ansys

Engagement Scores

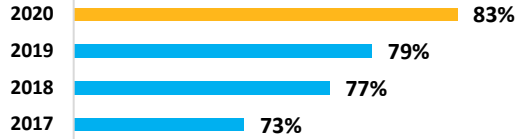

22% Women Employees Globally

24% Women on Senior Leadership Team

6.0% Employee Turnover Rate

Metrics for full-year 2020

Planet

CLEAN TECHNOLOGY CONTRIBUTIONS – OUR PRODUCT HANDPRINT

Ansys solutions support our customers in their efforts in sustainability as well as improving the efficiency, performance and durability of products. This has the positive effect of reducing total material use, increasing energy efficiency, reducing greenhouse gas emission, supporting the circular economy and increasing operational performance.

Practice

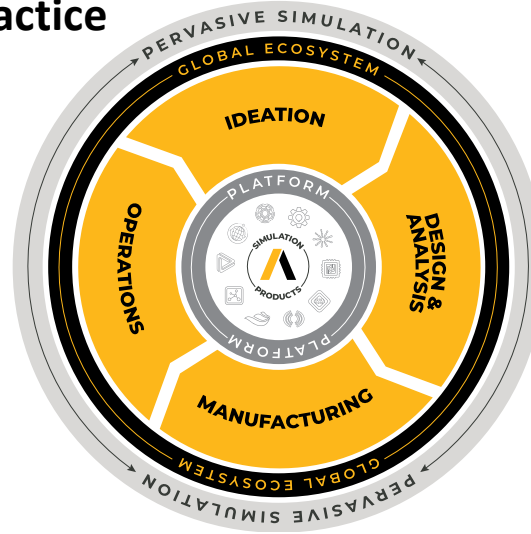

Innovation is one of our eight Ansys values. Our growth and financial strength reflect our leading technology position and commitment to innovation. This commitment to innovation ensures that we continue our progress toward our goal of enabling Pervasive Engineering Simulation™.

Product

Electrified Powertrain System Integration

Ansys' multiphysics and embedded software capabilities are applied at the system level, incorporating high fidelity models of key components to optimize the powertrain system for performance, safety and cost.

Power Electronics

Ansys' multiphysics capabilities are used to increase power density and lifetime, while reducing losses, thermal derating, noise and over-voltages

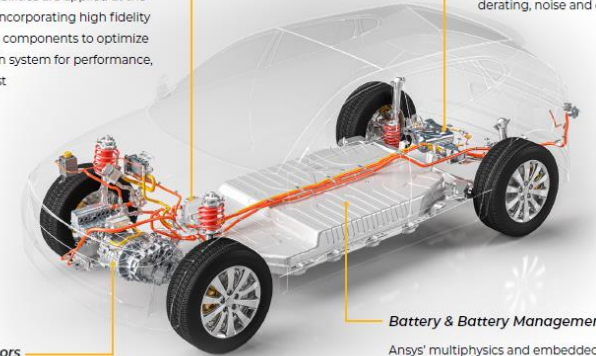

Electric Motors

Ansys' multiphysics and embedded software capabilities are used to evaluate motor efficiency and torque speed characteristics, optimize thermal management, address noise, vibration and harshness challenges and integrate the motor design with the control system

Battery & Battery Management Systems

Ansys' multiphysics and embedded software capabilities are used to advance and optimize battery and BMS development from the electrochemistry of the cell to the safety and performance of the system

Additional details and sources related to the Ansys Product Handprint use case for electric vehicles can be found here: [Ansys Product Handprint Use Cases](#)

Awards & Recognition



Ansys Simulation Solution Applied to Four Critical Electrification Technologies

Ansys simulation solutions are used by more than 90% of the world's leading automotive suppliers. As a leading provider of simulation solutions to the industry, in addition to traditional vehicle engineering challenges such as light-weighting and aerodynamic improvements, Ansys simulation solutions for electrification are applied in four critical technology areas, as shown above.

Our Priority ESG Topics

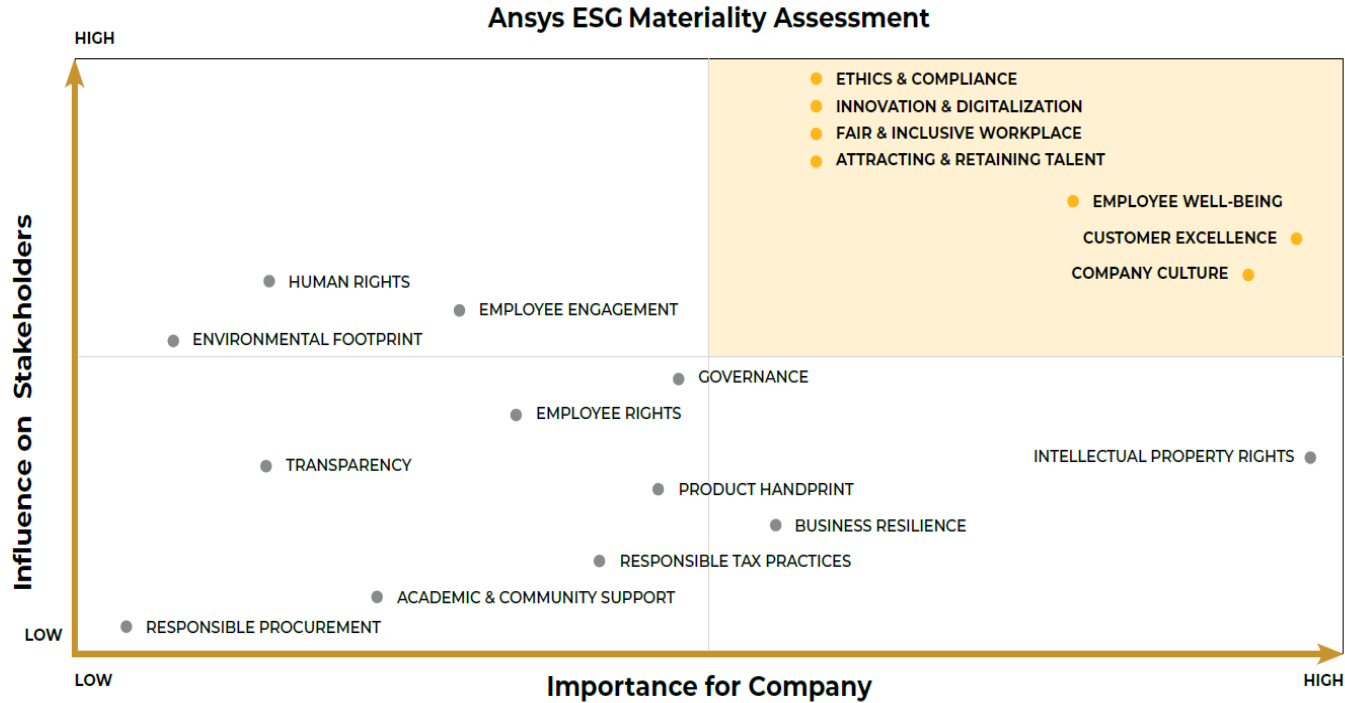

By collaborating with a materiality tool provider, Ansys conducted a formal, non-financial materiality assessment to identify sustainability areas that are important and priority ('material') for the company.

In addition to the internal and external stakeholder feedback, we also considered indirect stakeholder data, like news, social, policy and regulations and peer companies.

This assessment will be used to inform our corporate responsibility strategy and program, monitor potential risks and opportunities, or emerging issues that could affect our long-term business success, and to guide our environmental social and governance (ESG) decisions, disclosures and metrics.

The matrix presents priority topics to our stakeholders and our company. While all are important for us to manage and monitor, we have prioritized the seven that have the greatest importance to our stakeholders and our business. These are:

- Ethics & Compliance
- Innovation & Digitalization
- Fair & Inclusive Workplace
- Attracting & Retaining Talent
- Employee Well-being
- Customer Excellence
- Company Culture

World-class Companies Leveraging our Platform



ANSYS Offers the Only True Simulation Platform

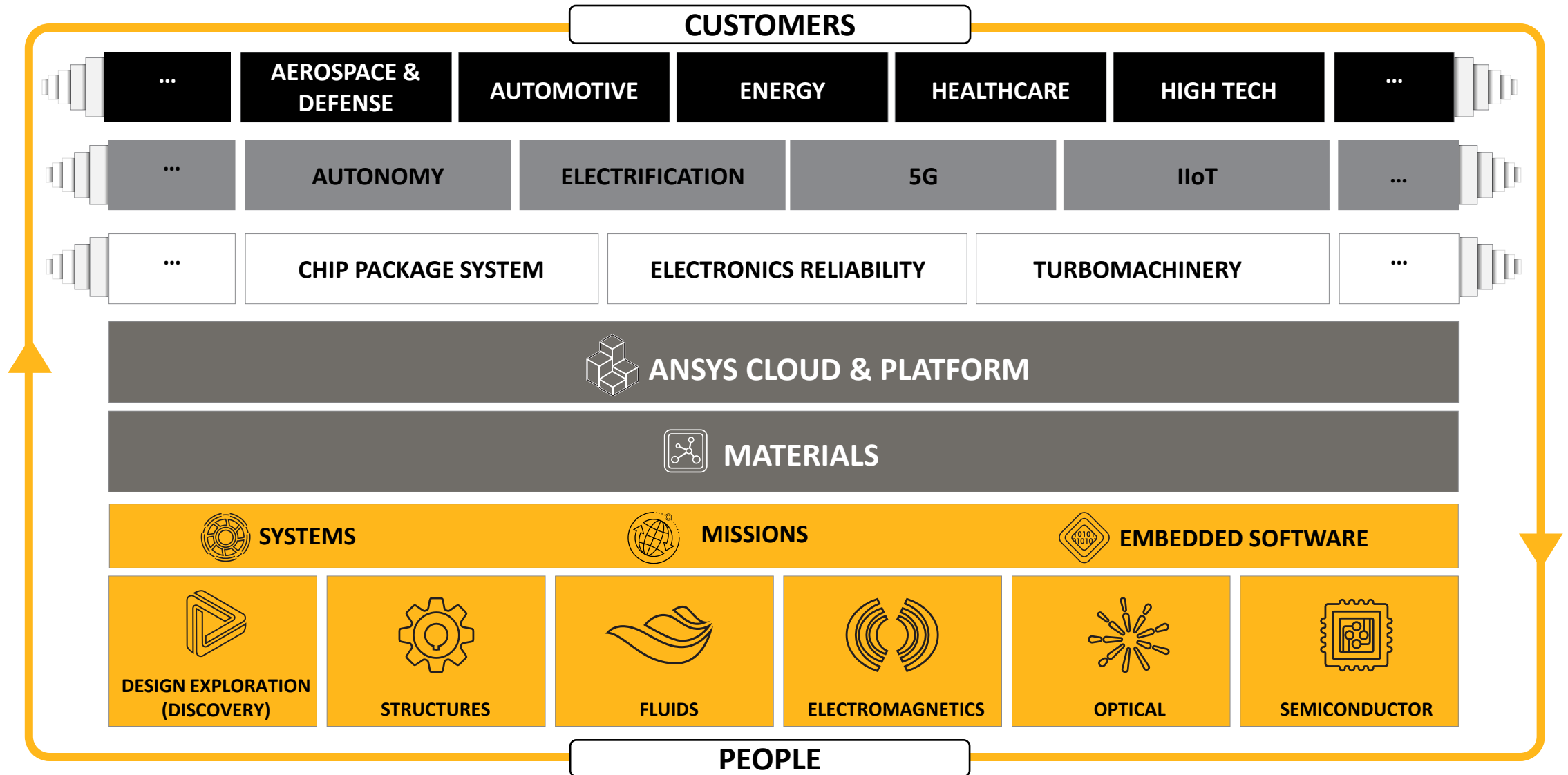

ANSYS' Simulation Provides Customers Top-Line Growth and Bottom-Line Savings

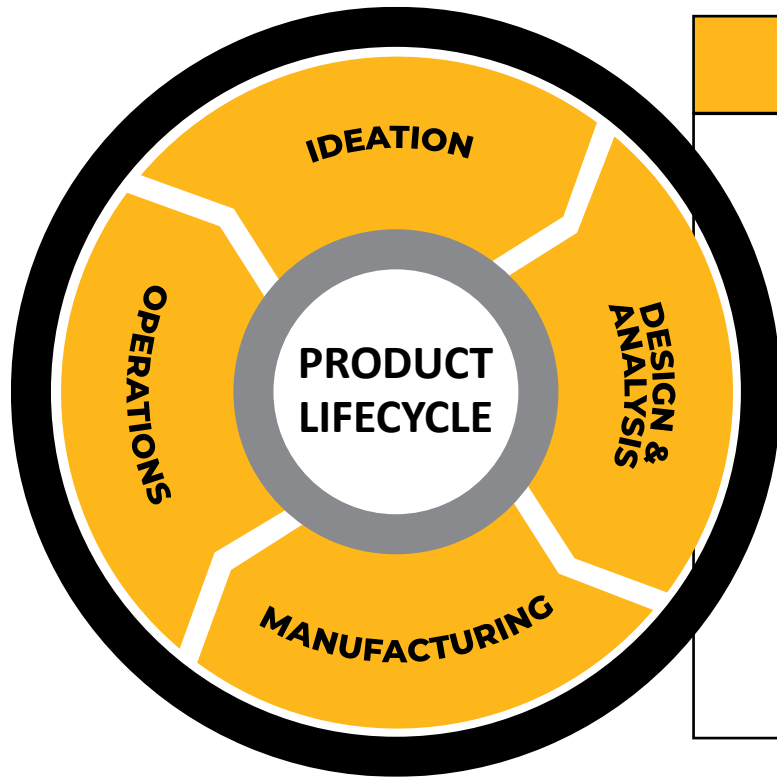

Simulation Impact

- Rapid innovation
- Lower cycle time
- Reduced risks
- Increased quality
- Manage complexity

Revenue Growth

- Offer more products
- Launch right products
- Faster time to market

Cost Savings

- Improved R&D efficiency
- Fewer physical prototypes
- Lower warranty costs

Strong Customer Trust Creating High Barriers to Entry

Our Differentiators

Degree of fidelity

Best-in-class and proven physics solutions

Advanced methods

Industry-leading platform

Delivered on-premises and in the cloud

Open ecosystem

World-class customer engagement

High
Barriers
to
Entry

Well Positioned in a Growing Market



**ANSYS IS THE
SIMULATION
MARKET LEADER**

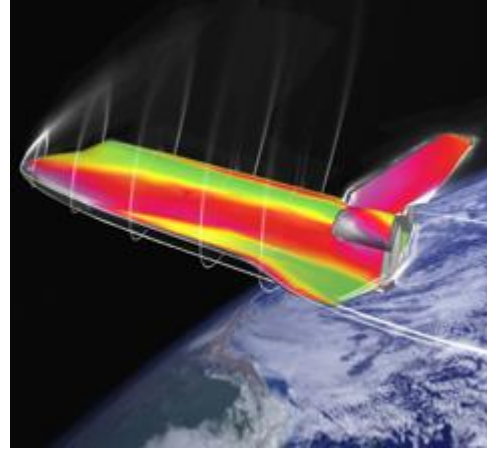

**THE SIMULATION
MARKET IS STRONG
AND GROWING**

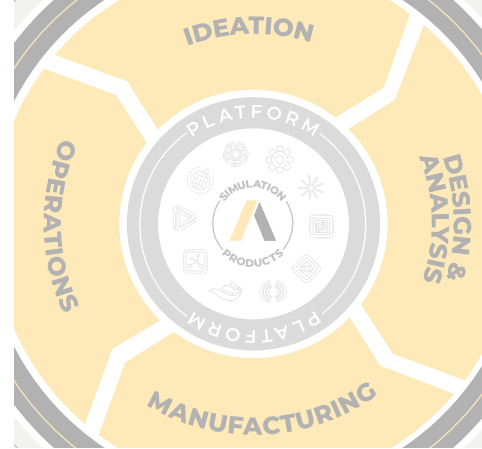

**OUR STRATEGY
CAPITALIZES ON
THIS GROWING
MARKET**



**WE HAVE A
PROVEN RECORD
OF EXECUTION**

The Ansys Total Addressable Market for Simulation will ~Triple in the Next 7-10 Years

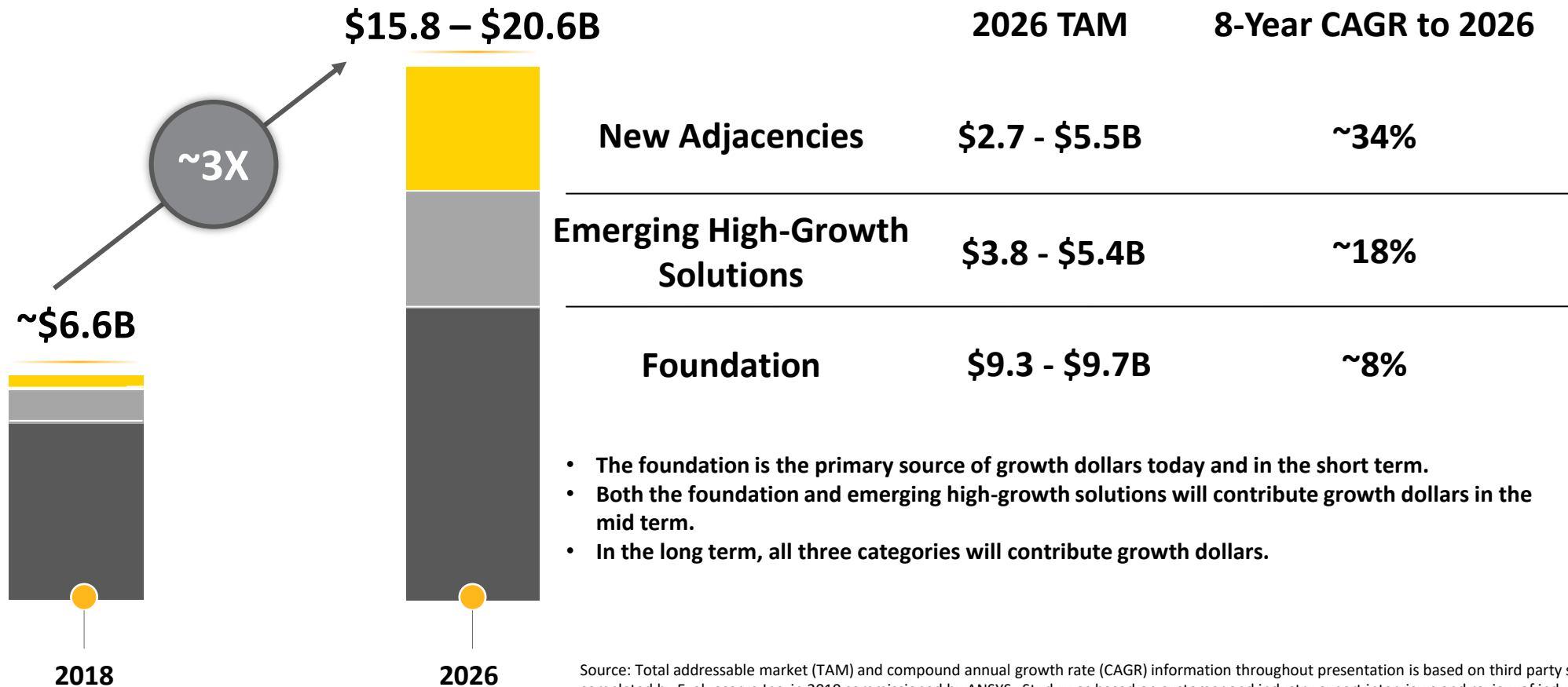

- The foundation is the primary source of growth dollars today and in the short term.
- Both the foundation and emerging high-growth solutions will contribute growth dollars in the mid term.
- In the long term, all three categories will contribute growth dollars.

Source: Total addressable market (TAM) and compound annual growth rate (CAGR) information throughout presentation is based on third party study completed by Evalueserve Inc. in 2019 commissioned by ANSYS. Study was based on customer and industry expert interviews and review of industry analyst reports and commentaries. TAM information presented throughout presentation does not reflect additional TAM opportunities from the acquisition of Analytical Graphics, Inc. (AGI) which closed on 12/1/2020. Refer to Cautionary Statement for a discussion of factors that could impact future financial results.

Emerging High-Growth Solutions: Cross-Industry Trends will Accelerate Growth

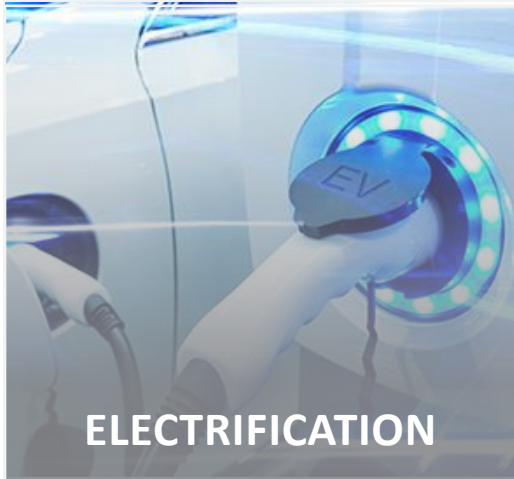

Play to our strengths

Disruptive market opportunities

**Large – and growing –
customer investment**

Unprecedented product complexity

**Requires extensive use
of simulation**

New Adjacencies: Substantial Growth into 2026 and Major Upside Beyond

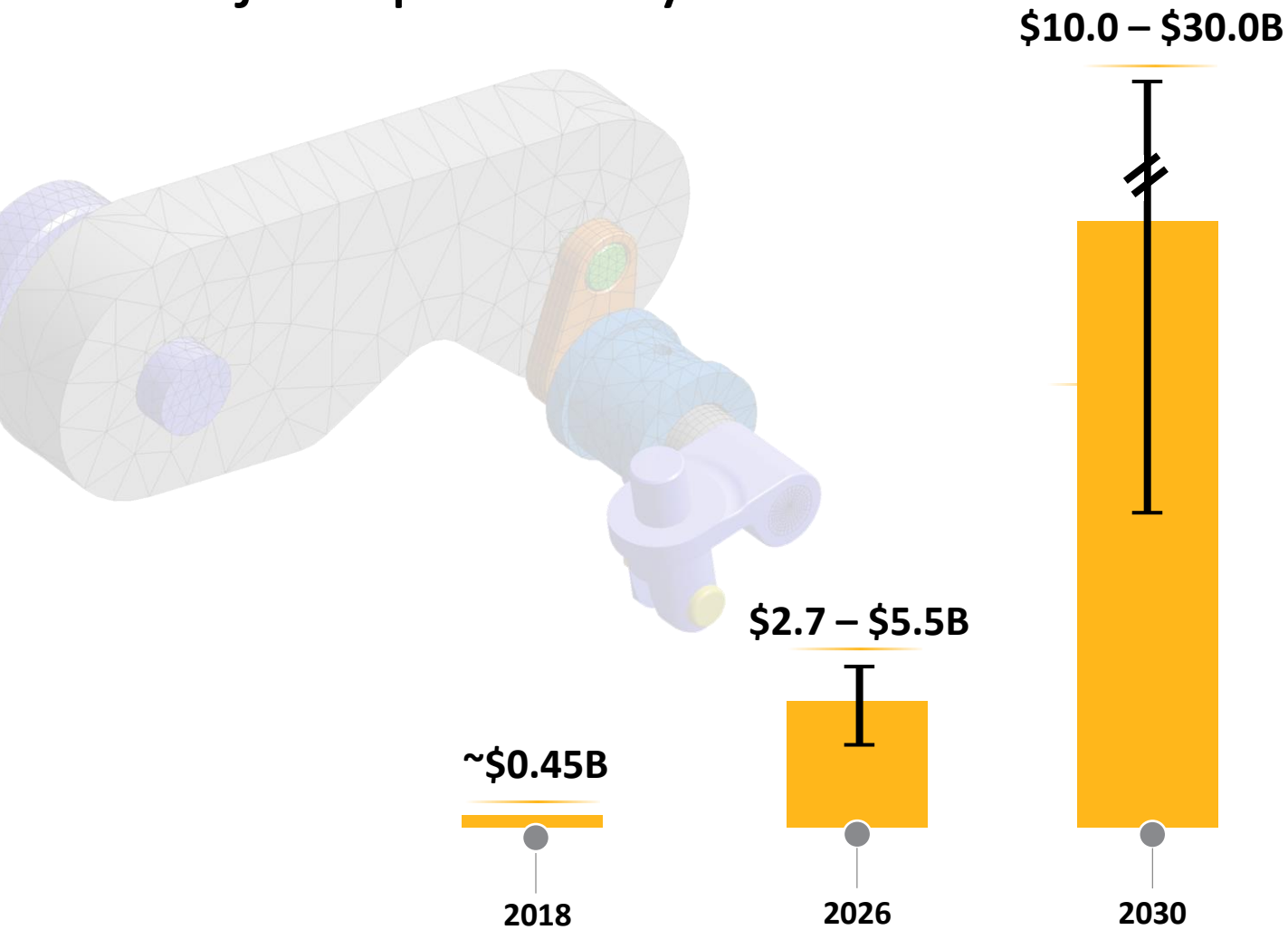

| New adjacencies | |
|------------------|------|
| 2026 TAM | CAGR |
| \$2.7 – \$5.5B | ~32% |
| 2030 TAM | CAGR |
| \$10.0 – \$30.0B | ~37% |

Adjacencies - Drive Simulation across the Entire Product Lifecycle

DIGITAL TWINS



Ansys Twin Builder – 2018

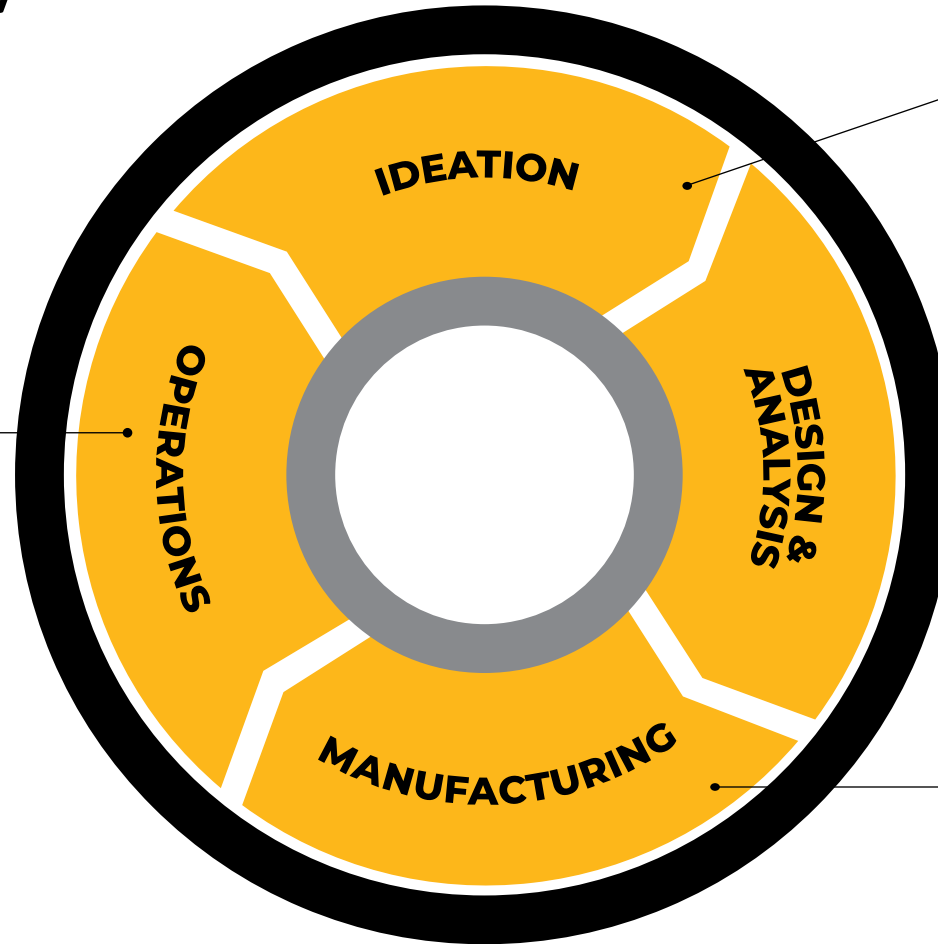

DIGITAL EXPLORATION

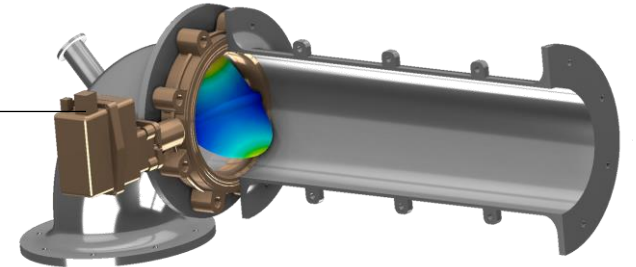

Ansys Discovery Live – 2018
Creo Simulation Live – 2019
Creo Ansys Simulation – 2020



ADDITIVE MANUFACTURING

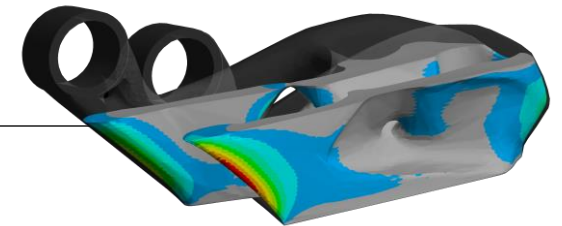

Ansys Additive Suite – 2018



Providing a Solution for Future Industry Leaders

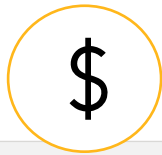

Key entry point for discounted software for early-stage, eligible startups



Product bundles organized by physics area



Partners from the beginning with aligned growth with the startup



STARTUP PROGRAM

Industry Segmentation

- **19%** High-Tech
- **14%** Aerospace & Defense
- **15%** Energy
- **12%** Healthcare
- **6%** Automotive
- **34%** Mix of smaller industries

"...Leveraging the suite of Ansys tools allows us to ensure a design works with limited test iterations, providing up to \$5 million in cost savings in engine cooling design, \$10 million in increasing engine thrust and up to \$500,000 in mass optimizations."

—
Tom Markusic
CEO of Firefly Aerospace



1,095
STARTUPS

161
GRADUATIONS

44
COUNTRIES

80% Growth
IN NEW LOGOS
IN LAST 2 YEARS
12/31/2018 – 12/31/2020

Strong & Growing Academic Program Seeding Future Users

Field Engagement

- **2,750+** Universities in 90 countries using Ansys simulation for teaching & research
- **1,500+** Universities using GRANTA EduPack
- **615+** with Multiphysics Campus-Wide Solution access
- **500+** Student teams sponsored



Scaling Digital Learning

- **1.5M+** Free student downloads spanning 151 countries
- **303k+** Peak Learning Forum total users in Q4 (previously Student Community)
- **28k+** Ansys Innovation Courses total users in Q4
 - **50+** Free courses and growing monthly



Strength in Key Partnerships

- **200k+** Registered students for the Cornell's Ansys edX course*
- **1,775** Registered students for the Technical University of Madrid's Ansys Online Master's Degree
- **5** Discovery courses at the University of Michigan
- **2** Curriculum Partners for Ansys Innovation Course content



Well Positioned in a Growing Market



**ANSYS IS THE
SIMULATION
MARKET LEADER**

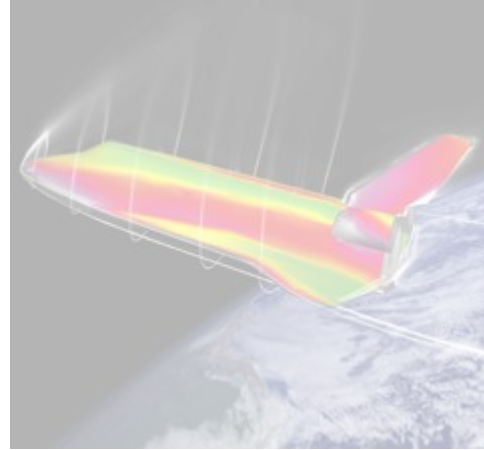

**THE SIMULATION
MARKET IS STRONG
AND GROWING**

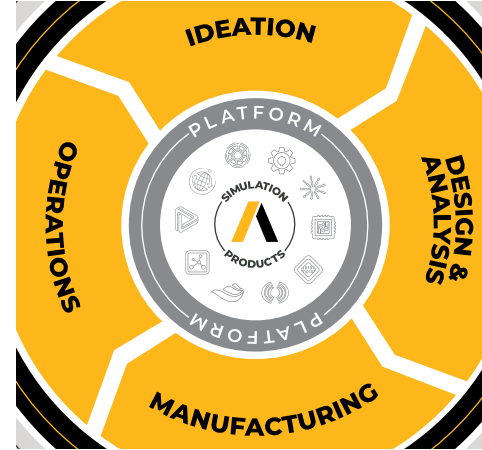

**OUR STRATEGY
CAPITALIZES ON
THIS GROWING
MARKET**



**WE HAVE A
PROVEN RECORD
OF EXECUTION**

Our Product Strategy is Based on Pervasive Simulation

Pervasive Simulation is:

- Integration across all physics on a single open platform
- And the injection of simulation into partner ecosystems

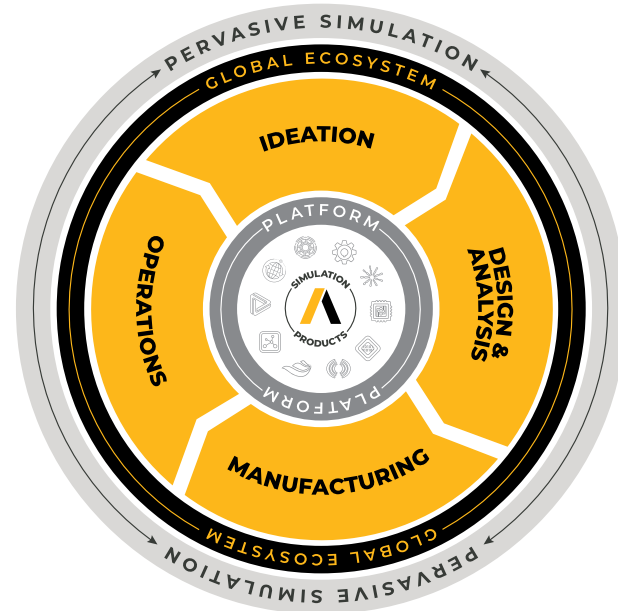

Our Product Strategy:

- Continuing investment to extend leading positions in all physics
- Leveraging and expanding platform to drive deeper client relationships
- Selectively targeting highest-growth market opportunities
- Accelerating opportunities and growth through world-class ecosystem

Our Strategy is Aligned with Market Growth:

Core

- Strengthen our foundation
- Deliver offerings for emerging high-growth solutions
- Will deliver the bulk of Ansys growth for the next 3-5 years

Expansion

- Drive simulation across the entire product cycle
- Embed Ansys into partners' ecosystems
- Provides significant upside to long-term growth

ANSYS Delivers What Matters Most to Customers



Accuracy



**True
Multiphysics**











**Close Technical
Partnership**



**Advanced
Methods**

We Are Uniquely Positioned to Make Simulation Pervasive

| | #1 STRUCTURES  | #1 FLUIDS  | #1 ELECTRONICS  | #1 SEMICONDUCTOR  | #1 EMBEDDED SOFTWARE  | #1 MATERIALS INFORMATION  | #1 OPTICAL  | #1 MISSIONS  |
|---------------|---|---|--|--|--|--|--|---|
| Ansys | ● | ● | ● | ● | ● | ● | ● | ● |
| COMPETITOR #1 | ○ | ○ | ○ | | | | | |
| COMPETITOR #2 | ○ | ● | ○ | | ○ | ○ | ○ | |
| COMPETITOR #3 | ● | ○ | ● | | ○ | | | |
| COMPETITOR #4 | ○ | ○ | ○ | | ○ | | | |
| COMPETITOR #5 | ○ | ○ | | | | | | |
| COMPETITOR #6 | ○ | | | | | ○ | | ○ |
| COMPETITOR #7 | | | | | | | ● | |
| COMPETITOR #8 | | ● | | | | | | |
| COMPETITOR #9 | | | ● | ● | | | | |

● - Best of Breed Offering

○ - More Limited Offering



Continuously Investing to Strengthen the Core — Organically and Through Acquisitions

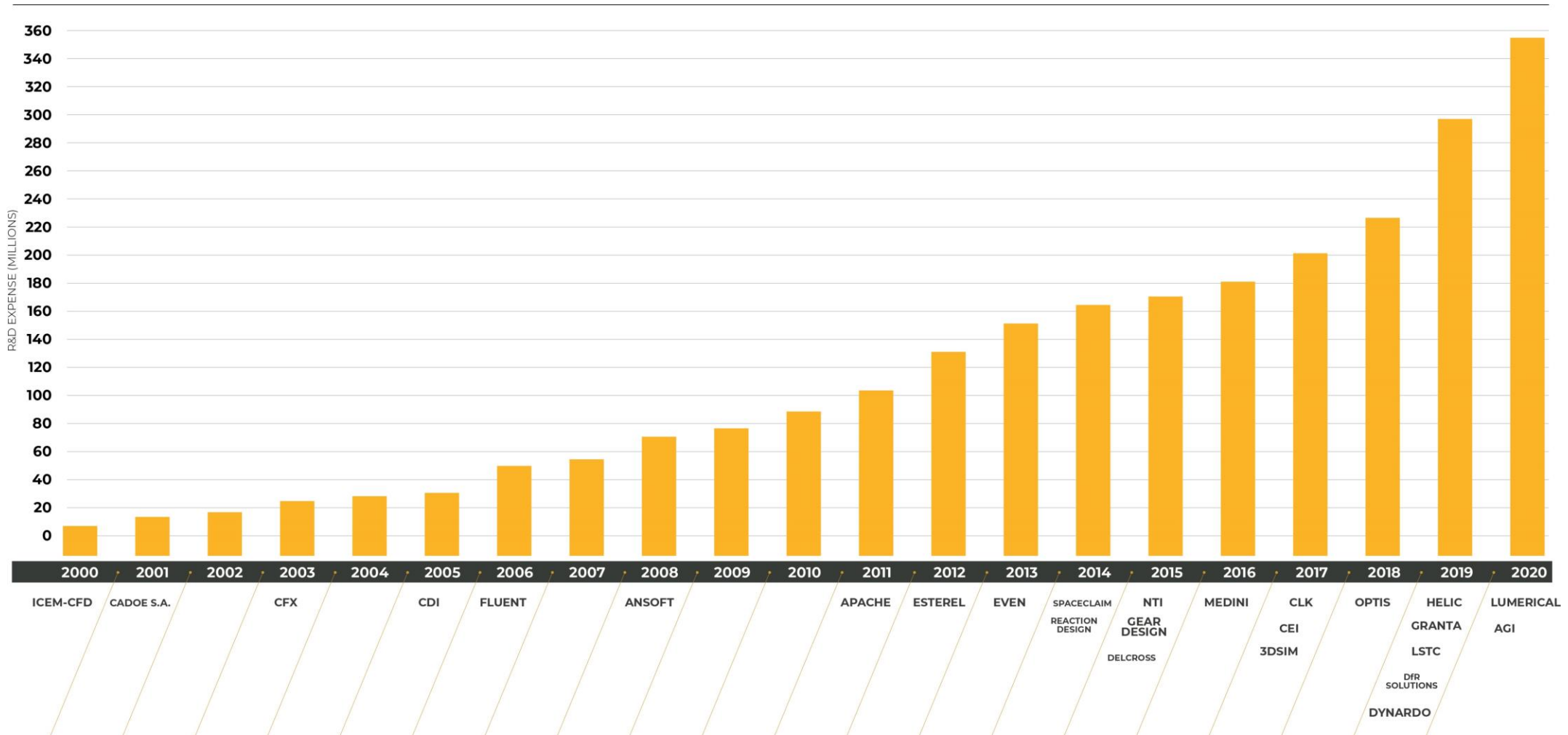

ANSYS 2021 R1 Key Updates – Released January 2021



STRUCTURES

TAMING COMPLEXITIES

- New short fiber composites solution
- Enhanced electronics modeling with LS-DYNA
- Complete back-to-CAD workflow for topology optimization



FLUIDS

REMOVING BARRIERS AND PUSHING LIMITS

- New CFD 'Pro' product offers Fluent at the entry-level
- Improved convergence & accuracy for high-speed flows
- New built-in fluid-structure interaction (FSI) in Forte provides rapid valve solutions



ELECTROMAGNETICS

NEW STANDARDS IN SPEED AND CAPACITY

- No limits with HFSS Mesh Fusion
- Easy thermal insight with Mechanical solver in Ansys Electronics Desktop
- More efficient electric motor analysis



DESIGN

DESIGN EXPLORATION FOR EVERY ENGINEER

- Discovery VDI launcher for interactive use on Ansys Cloud
- Direct model transfer to Mechanical & Fluent
- Automated high-fidelity conjugate heat transfer



MATERIALS

EMPOWERING MATERIALS DIGITAL TRANSFORMATION

- New Battery Designer tool
- Enhanced company-wide materials management
- Expanded materials data alongside Ansys solvers

ANSYS 2021 R1 Key Updates – Released January 2021



EMBEDDED SOFTWARE

EFFICIENT DEVELOPMENT OF SAFE SOFTWARE

- Data modeling and code generation for FACE 3.0
- Greater flexibility for AUTOSAR software design
- Incremental design reviews & model change reports



OPTICAL

HIGHER PRODUCTIVITY FOR OPTICAL VALIDATION

- Ansys SPEOS now compatible with Ansys Cloud
- Scanning and Rotating LiDAR sensor systems
- Design cycle compression with SPEOS Live Preview



DIGITAL TWIN

STREAMLINED WORKFLOWS FOR TWIN CREATION

- Visualize 3D fields for deployed equipment
- Autogenerate integration code to ease deployment
- New toolkits and libraries for easier model building



SEMICONDUCTOR

ENABLING ADVANCED 5G, HPC AND AI DESIGNS

- Enhanced voltage-timing flow for IC designs
- Multiphysics solution to detect hardware security vulnerabilities
- Early-design power analytics to maximize IC design parametric yield



PLATFORM

ACCELERATE INNOVATION IN ANY ENVIRONMENT

- New ways to configure and visualize the digital thread
- New AEDT connector for data check-in, check-out
- Productivity and UX accelerators for projects, dashboards & configurations

ANSYS 2021 R1 Key Updates – Released January 2021



PHOTONICS

IMPROVED WORKFLOWS & NEW CAPABILITIES

- Integration with Ansys License Manager
- Automated data collection workflows
- Spatial correlation in photonic circuit yield analysis



SAFETY

ACCELERATED SAFETY & SECURITY ANALYSIS

- Enhanced fault tree evaluation with FTA heat map
- New System Weakness Analysis for SOTIF
- Unified safety and security analysis



OPTIMIZATION

ACCELERATED INTEGRATION INTO ANSYS PORTFOLIO

- Advanced optimization now integrated into AEDT
- Automations published as web apps to Ansys Minerva
- Faster optimization with new AI/ML algorithms



AUTONOMOUS

PHYSICS-BASED SIMULATION OF AUTONOMOUS VEHICLES

- New GPU accelerated real-time physics-based radar solver
- Simulate camera, lidar and radar in a unified simulation
- Conduct driving simulation on Microsoft Azure via Ansys Cloud



MISSIONS

SOFTWARE FOR DIGITAL MISSION ENGINEERING

- Study the entire system in action, at any location and at any time
- Simulate product deployment in a physics-based operation environment
- Gain a clear understanding of system behavior and mission performance

ANSYS Long-Term Technology Strategy Dimensions



Artificial Intelligence and Machine Learning

- Simulation used to train AI methods
- AI used to improve simulation
- ML-based Models & data confluence



Digital and Physical Worlds

- AR/VR for simulation brings digital world to physical
- IOT and connectedness brings physical world to digital
- Smart energy, smart Cities



Platform for Multiphysics simulation

- Seamless simulation & visualization process
- Robust Multiphysics, Multi-disciplinary Optimization
- Azure/AWS microservices for simulation



Digital Transformation

- Digital threads, digital continuity, digital twins
- Model-Based Systems Engineering
- Simulation-led engineering outcome



Hyperscale Simulation, Collaboration on Cloud

- GPU, SMP, MPI, Task based
- Quantum computing
- Hyperscale Real Time Simulation

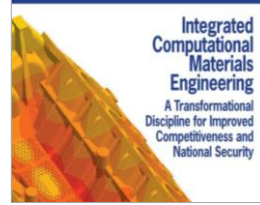

Computational Methods in New Areas

- Integrated computational materials engineering
- Computational chemistry, drug design, healthcare,
- Photonic IC, 3D IC, digital manufacturing



Predictive and Robust Design

- High accuracy, adaptive numerical methods
- Integrated Verification and Validation
- Uncertainty Quantification

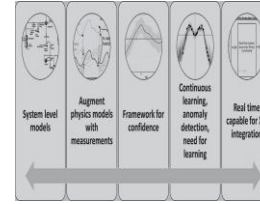

How can Simulation be Disrupted?

- ML-based flow-solver, generative design
- Integrated synthesis and verification
- Automated Mixed mode (0D-4D), MF, MS simulation

Investing in Four Key Product Initiatives to Drive Growth









1 CAPITALIZE ON RECENT
ACQUISITIONS

2 GROW INDUSTRY-LEADING
SIMULATION PLATFORM

3 EXPAND INTO NEXT-
GENERATION USE CASES

4 GROW GLOBAL
PARTNER ECOSYSTEM

Capitalize on Recent Acquisitions

| | ADJACENCIES | | | EMERGING HIGH-GROWTH SOLUTIONS | | | |
|--|---------------|------------------|--------------|--------------------------------|------------|----|------|
| STRENGTHENS CORE | ADDITIVE MFG. | DESIGN ENGINEERS | DIGITAL TWIN | ELECTRIFICATION | AUTONOMOUS | 5G | IIoT |
|  GRANTA MATERIAL INTELLIGENCE | ✓ | ✓ | ✓ | ✓ | ✓ | ✓ | ✓ |
|  Helic | | | | | ✓ | ✓ | ✓ |
|  DfR | | ✓ | ✓ | ✓ | | | |
|  OPTIS | | | ✓ | | ✓ | | ✓ |
|  LSTC Livermore Software Technology Corp. | ✓ | | | ✓ | ✓ | | |
|  dynardo dynamic software & engineering | ✓ | ✓ | ✓ | ✓ | ✓ | | ✓ |
|  lumerical | | ✓ | | | ✓ | | ✓ |
|  AGI | | | ✓ | ✓ | ✓ | ✓ | ✓ |

Acquired Digital Mission Engineering Leader AGI – December 2020

Technology Stack Integrated from Component to System of Systems

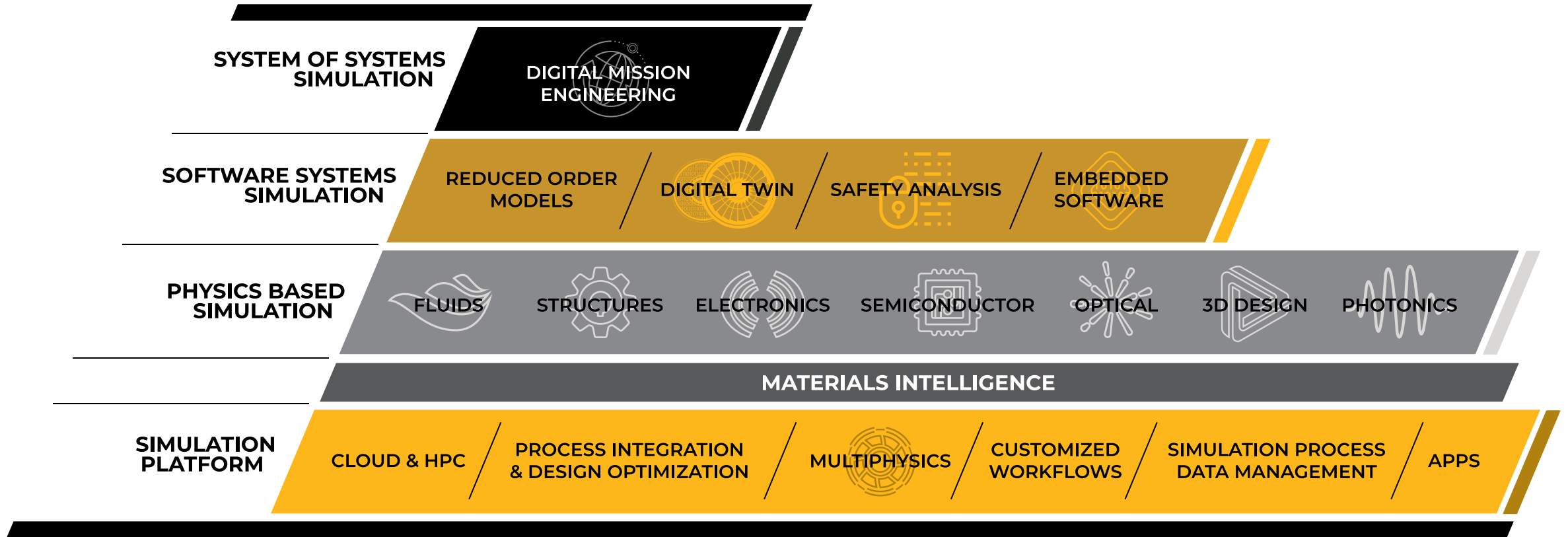

2. Ansys Comprehensive Portfolio for Digital Engineering Workflows

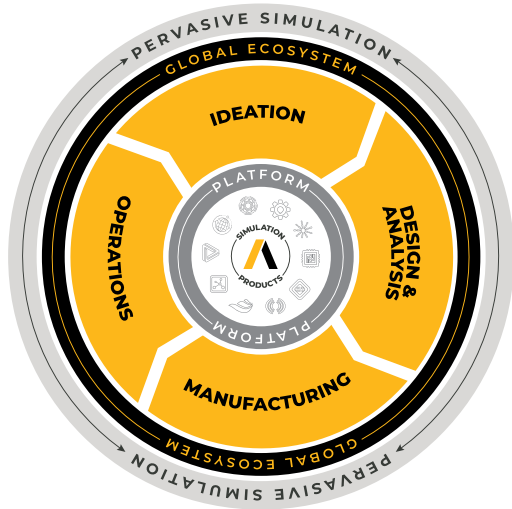

Comprehensive Multiphysics + Collaborative Simulation and optimization + Materials information management

Ansys Minerva

| | | |
|----------------------------|-------------------------|-------------------------|
| Multiphysics collaboration | Simulation applications | SPDM |
| Simulation Projects | Simulation Data Science | Hybrid HPC integration |
| Visualization | Simulation Analytics | Enterprise connectivity |

Ansys optiSLang

- Simulation Workflow
- Cx Automation
- Robust Design
- Optimization

Ansys Multiphysics

| | |
|----------------|-------------------|
| Structures | Fluids |
| Electronics | Systems |
| Semiconductors | Embedded Software |
| Workbench | TwinBuilder |

Ansys Granta MI

- Materials intelligence
- Materials exploration
- Materials data
- Materials compliance

Customer Ecosystem

| | |
|-----|---------|
| PLM | ALM |
| ERP | IIoT |
| TDM | Inhouse |
| .. | |

+ Strategic partner ecosystem



Ansys Cloud - 2021 R1

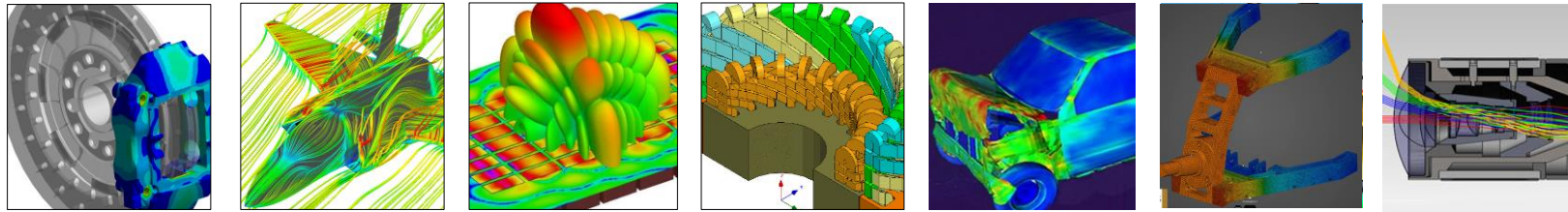

Mechanical

Fluent

HFSS,
Siwave, Icepak**

Maxwell*,
Q3D (2D & 3D)*

Ansys
LS-DYNA***

Ansys
Discovery

Ansys Speos



- ✓ **Solve in the cloud** directly from the desktop application
- ✓ **Highly optimized** for Ansys solvers
- ✓ **Single vendor solution** for Software + Hardware
- ✓ **Nine data centers** worldwide
- ✓ **Data localized and secured**

Compute Nodes

- ✓ High memory bandwidth
- ✓ Large capacity RAM
- ✓ High performance interconnect
 - ✓ Low latency message passing interface (MPI)
 - ✓ High bandwidth
- ✓ Faster working directory

HPC Optimized

- Better Price/Performance: out-of-box support up to 960 cores; higher for custom configurations
- Increased flexibility for flagship solvers
- New Ansys Electronics Desktop (AEDT) Configurations

Interactive workstations

- Supporting Nvidia GPU, up to 120 cores

New simplified pricing

- Ansys Elastic Currency
- Ansys Managed Hardware Solution

New Products

- **SPEOS** in the Cloud : More Speed, More Flexibility, **Up to 60X** faster than local computing
- **DISCOVERY** in the Cloud: Bring **more Physics in Browser**
- Improvement in **AEDT**: **Optimize performance/cost ratio** of simulation



3. Expanding our Technology to Enable Emerging Solutions and Adjacencies

Ansys Addressable Market (2026)

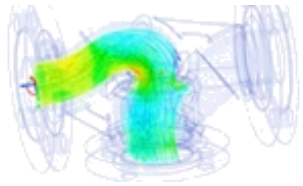

Upfront Simulation

PROJECTED MARKET SIZE **\$1.4-2.0B**



Digital Twin / IIoT

PROJECTED MARKET SIZE **\$1.2-3.3B**

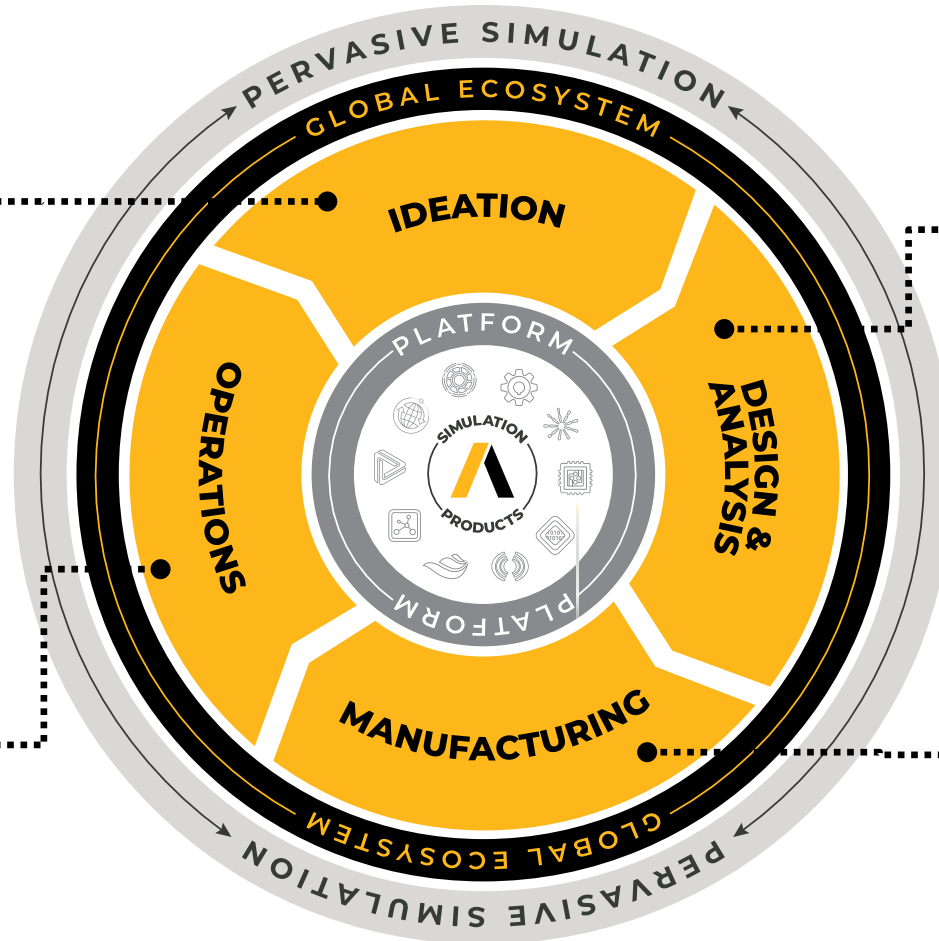

Emerging Solutions

PROJECTED MARKET SIZE **\$3.8-5.4B**

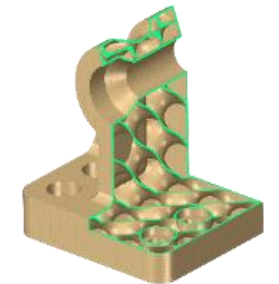

Additive Manufacturing

PROJECTED MARKET SIZE **\$0.1-0.2B**



5G is Everywhere

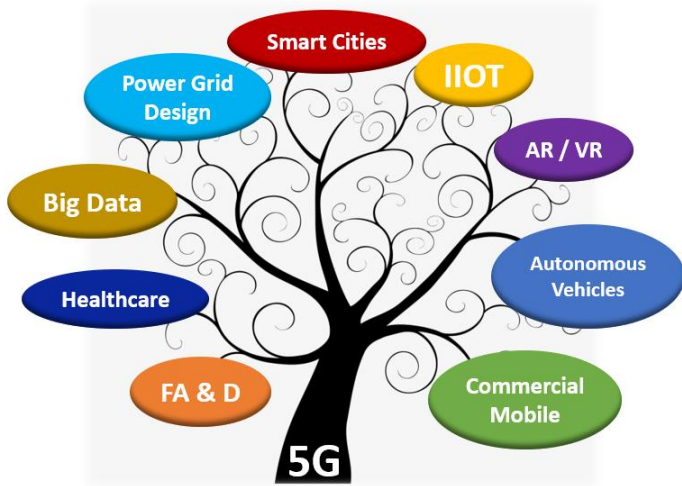

5G Network

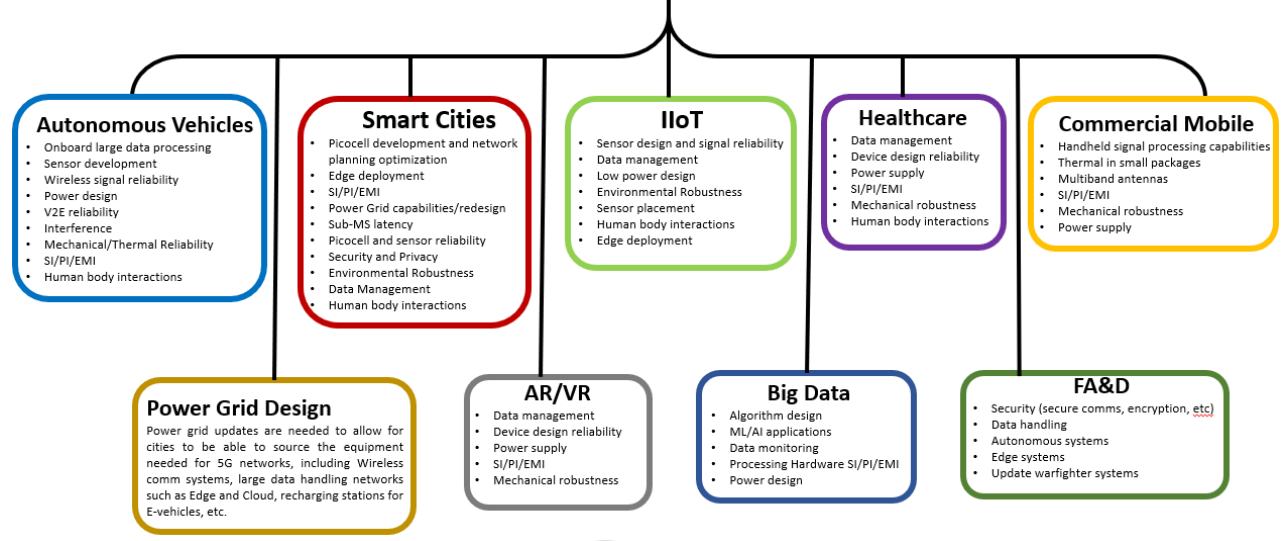

DEVICES

NETWORKS

DATA CENTERS

Mobile IoT Automotive

Wireless

Compute / Cloud



Pervasive Engineering Simulation Means Saying Hello to 5G with Ansys

ANSYS products and capabilities for Wireless and Semiconductor design from 3G to 4G and now 5G, are the trusted source for enabling customer simulation-driven solutions for the User Equipment (UE) and Devices, Network, and Data-centers

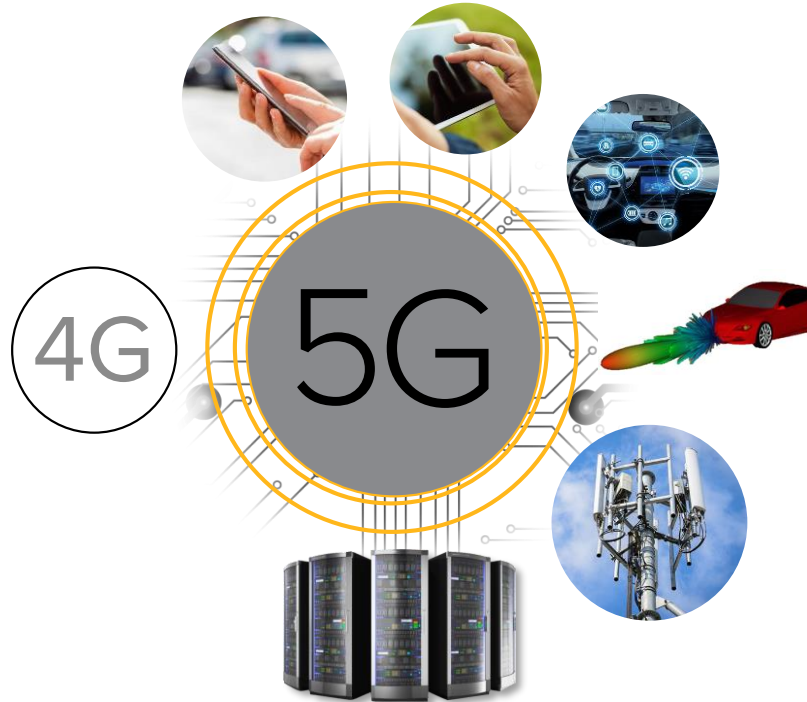

Electronics Integration Complexity

Multi-chip and multi-die power integrity, complex mixed signal, Electronics and SoC reliability, Dense RF Front-end (RFFE), Carrier Aggregation (CA)

Semiconductor SoC and 3D IC Designs

RTL Power and Sign-off in the IC Design Flow including ,low Power, SoC and IP analysis, Package and board level integrity analysis (Signal, Thermal, Power, EM), EM crosstalk, and ESD and EMC simulations for user equipment (UE) and networks

UE and Base Station (BS) Advanced Antennas

Complex Phased Array Beamforming, Advanced Channel Modeling, mmWave, Massive MIMO, Carrier-Aggregation

Base Station (BS) Performance

Physics-based simulation of large-scale Metro environments, and evaluation of system performance – Antennae Array, Site, UE received power, beam-forming, BS-BS handoffs, and interference

Data Center Electronics

Integrity analysis – Signal for fast channels (SERDES, PAM4), Power and Thermal , Board-level virtual prototypes, PCB reliability, Die-level packaging issues, Electronics reliability (EMI, Electromigration, Thermal),

Driving your Performance, Cost-Savings, and Workflow Efficiency thru Strong Partnership, Outstanding Customer Service, and Great Communication.



3. Ansys Electrification Solutions

Leader in Electrification

- 50 Years Focus on Simulation
- Breadth/Depth of Multi-Domain/Multi-Technology Solutions
- Open Platform

Four Pillars

1. Battery & BMS
2. Power Electronics
3. Electric Machines
4. Electrified Propulsion System

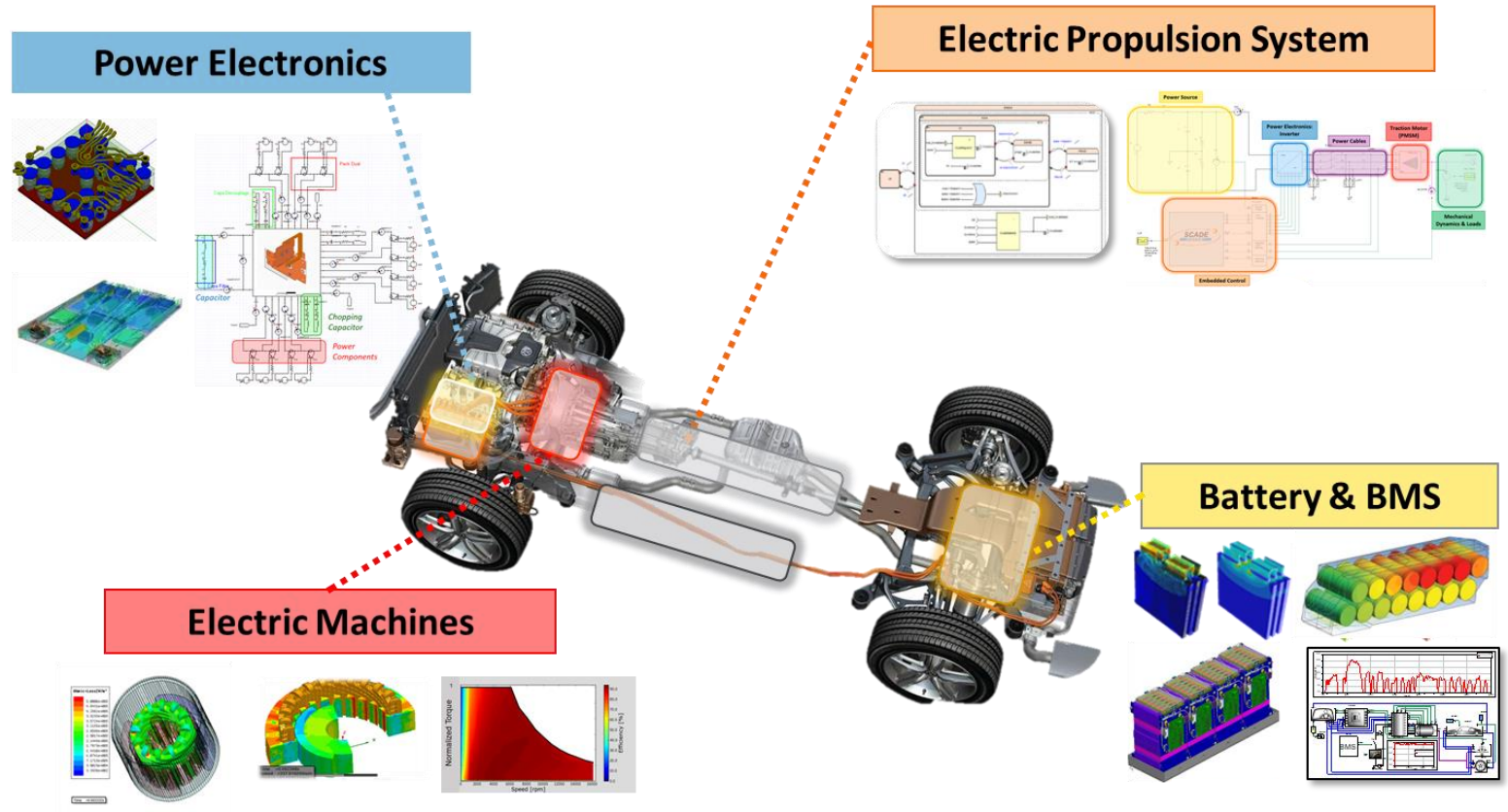

3. Ansys Autonomy Simulation Toolchain

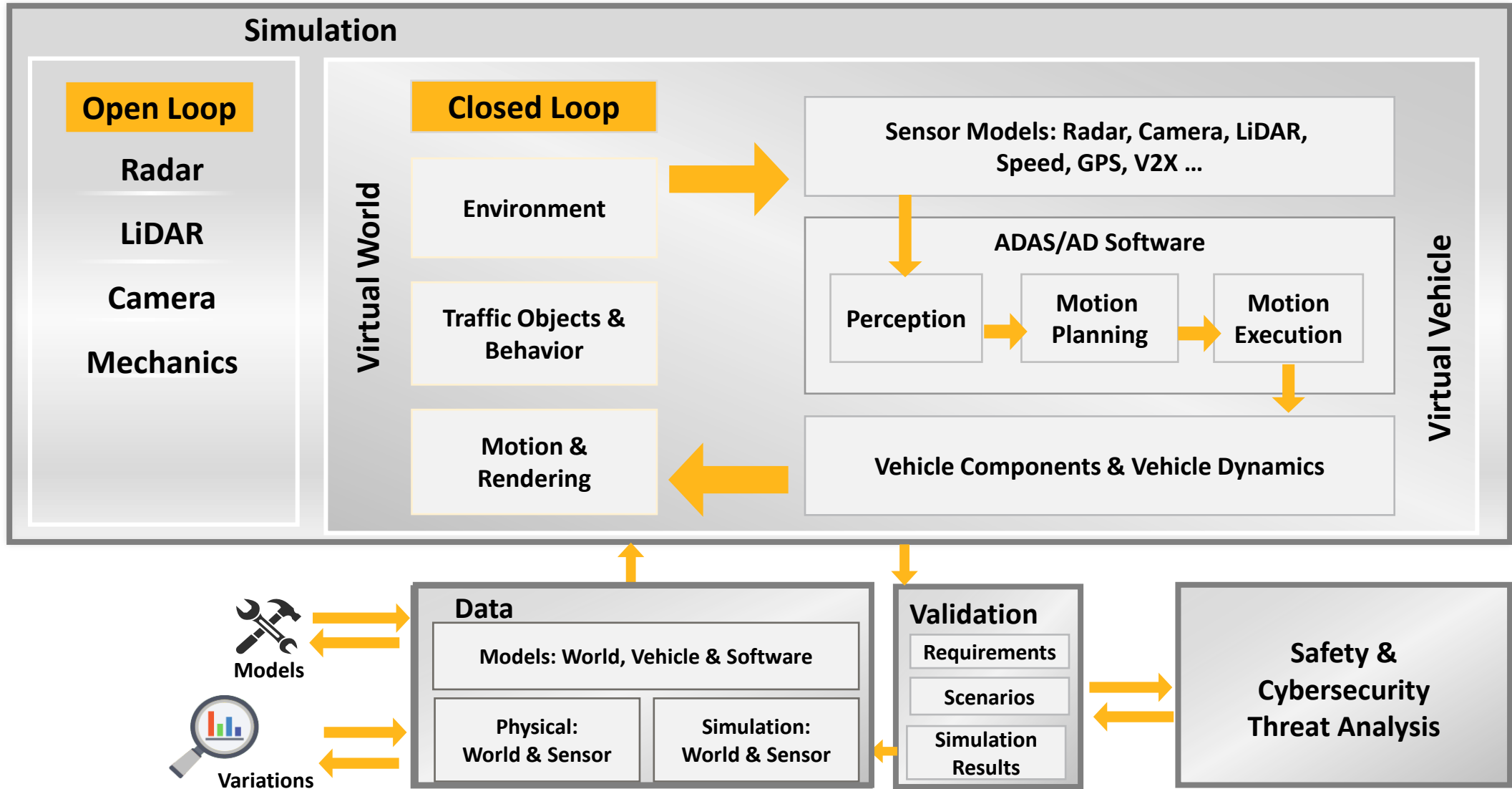

4. Partnerships Expand Ansys Simulation into Other Ecosystems

Go-to-market expansion through partner activities

| | |
|----------------------------|--|
| Microsoft | <ul style="list-style-type: none">• Ansys Cloud, built on Azure, realized several key enhancements in Q4 that expanded hardware options, regional availability, and licensing options. Joint Ansys-Microsoft sales activity is driving rapid pipeline growth and the positive Q4 sales numbers reflect this momentum.• Digital Twin co-development with Microsoft continues, focused on predictive maintenance and equipment optimization. Pilot with a global energy customer is expected to conclude in March and new Pilots are starting. Digital twins will be included in Microsoft co-sell process starting in Q3/Q4.• The first joint sales win for Autonomous Vehicle simulation (VRXPERIENCE) was recorded in Q4. Additional automotive sensor supplier customers are piloting the solution on Azure and the scope of Ansys-based AV technology migrating to the cloud continues to expand. |
| PTC | <ul style="list-style-type: none">• Creo Simulation Live integrates real-time simulation directly into the Creo 3D CAD modeling environment to get instant feedback for designers. And Creo Ansys Simulation, including a subset of Ansys flagship structural, thermal and modal solvers within Creo, was released in Q4 2020.• PTC recently reported Creo Powered by Ansys products grew bookings by more than 20% in the quarter, with expansion activity accounting for roughly half of bookings. And for its FY 2021, PTC is targeting a high-single digit % of CAD bookings for the Creo Powered by Ansys products. |
| Synopsys | <ul style="list-style-type: none">• Synopsys IC Compiler™ II with Ansys RedHawk™ Analysis Fusion - Delivers cohesive and integrated workflow that shortens time on challenging power requirements.• Addressing the rapidly growing 3D integrated circuit (3D-IC) market Synopsys has integrated Ansys RedHawk Family into Synopsys's 3DIC Compiler to optimize overall system solutions for power, signal, and thermal management.• The 3DIC Compiler integration saw traction in Q4 with adoption from Samsung Foundry. Working with Synopsys, they accelerated their design productivity and reduced turnaround time from months to hours. |
| Rockwell Automation | <ul style="list-style-type: none">• Our strategic partnership with Rockwell provides industrial companies with the ability to deploy simulation-based digital twins to improve the design and operation of their products and manufacturing processes.• The partnership helps customers optimize factory operations, saving money by reducing unplanned downtime and enabling engineers to test virtual "what if" scenarios without disrupting physical assets. |

4. Partnerships Expand Ansys Simulation into Other Ecosystems

Go-to-market expansion through partner activities

| | |
|---------------------|---|
| Autodesk | <ul style="list-style-type: none">• The partnership allows seamless interoperability between selected Ansys and Autodesk products to break down silos in the product development process, driving revolutionary design and engineering agility for our customers.• A designer-to-simulation analyst workflow connects Autodesk Fusion 360, integrated design and manufacturing software, with Ansys Mechanical and Ansys Discovery simulation solutions to expedite products to market.• A connected workflow for automotive companies combines Autodesk's VRED automotive 3D visualization and virtual prototyping software with Ansys' physics-based lighting simulation solutions. |
| SAP | <ul style="list-style-type: none">• Ansys and SAP continue to support Ansys runtime twins within SAP's Enterprise Product Development (EPD) platform.• The market focus is expanding from Operators to OEMs to align with digital transformation initiatives where equipment suppliers are offering more software and services along with their products. |
| BMW Group | <ul style="list-style-type: none">• Ansys and BMW Group are partnering to create the automotive industry's first holistic simulation tool chain for developing autonomous vehicle technologies.• BMW Group is leveraging Ansys' broad pervasive engineering simulation solutions and experience to speed up the development of a safety-focused solution for the validation of Autonomous Driving systems. |
| AVSimulation | <ul style="list-style-type: none">• Ansys and AVSimulation are partnering to speed the development of safe autonomous driving for automobile manufacturers.• The collaboration integrates revolutionary simulation technology from AVSimulation with Ansys' immersive autonomous driving simulation solutions, expediting vehicle design and validation by using virtual testing. |
| Airbus | <ul style="list-style-type: none">• Through a new collaboration, Ansys and Airbus plan to develop a new Ansys solution for enabling safety-critical flight controls with sophisticated artificial intelligence (AI), aiming at autonomous flight by 2030.• The intent is to engineer an advanced Ansys SCADE® tool that links traditional model-based software development with new AI-based development flow. This certified safe AI solution will be pivotal to reducing development time and expenses. |

ANSYS Discovery: Breaking the Barriers to Upfront Simulation

Design Exploration

- Real time interactive simulation for rapid evaluation and experimentation
- Structural, thermal, fluids & multiphysics
- “Just works” simulation that is tolerant of dirty geometry and imprecise modeling
- Fast topology optimization

Design Verification

- Trusted ANSYS solvers for high-fidelity results
- MAPDL for structures & thermal
- Fluent for fluids and conjugate heat transfer
- Extended physics including non-linearities and bolt pre-tensioning
- Export to Mechanical/Fluent

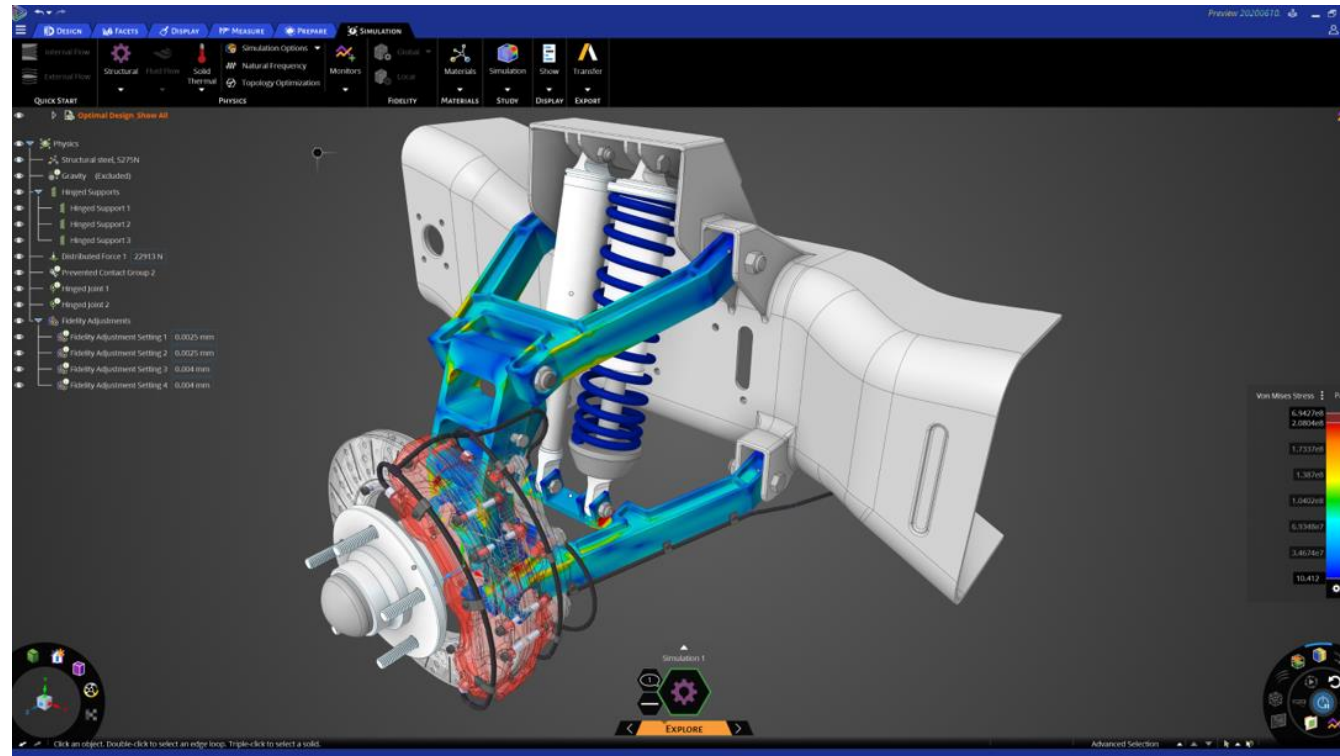

The “live” demo of Discovery can be found on the [Ansys IR Home Page](#)

Innovative User Experience

- Single environment for all physics that includes setup, solve, and post-processing
- Compressed workflows w/ sophisticated automation & intelligence
- Major focus on ease of learning and ease of reuse through guidance and feedback

Geometry Preparation

- Dedicated tools for simulation prep
- Import & edit CAD from any source
- Faceted and BREP
- Direct and history-based modeling

And More

- Granta materials
- Prep and simulation for Additive
- DoE and optimization
- Scripting & extensibility

Demonstrated Return on Investment in Upfront Simulation

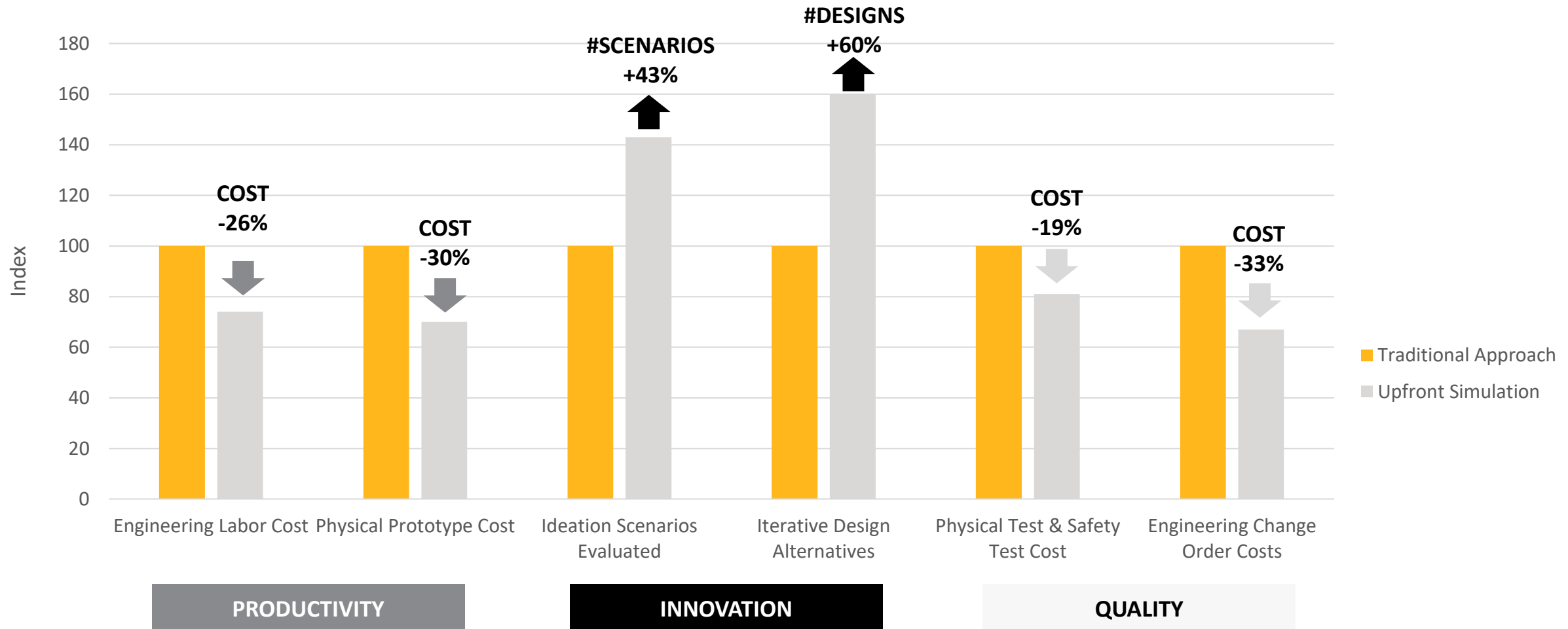

Source: "Quantifying the Return on Investment in Simulation Lead Design Exploration." Data based on third party survey completed by Mediafly, 2020 and commissioned by Ansys.



Ansys Additive Solutions

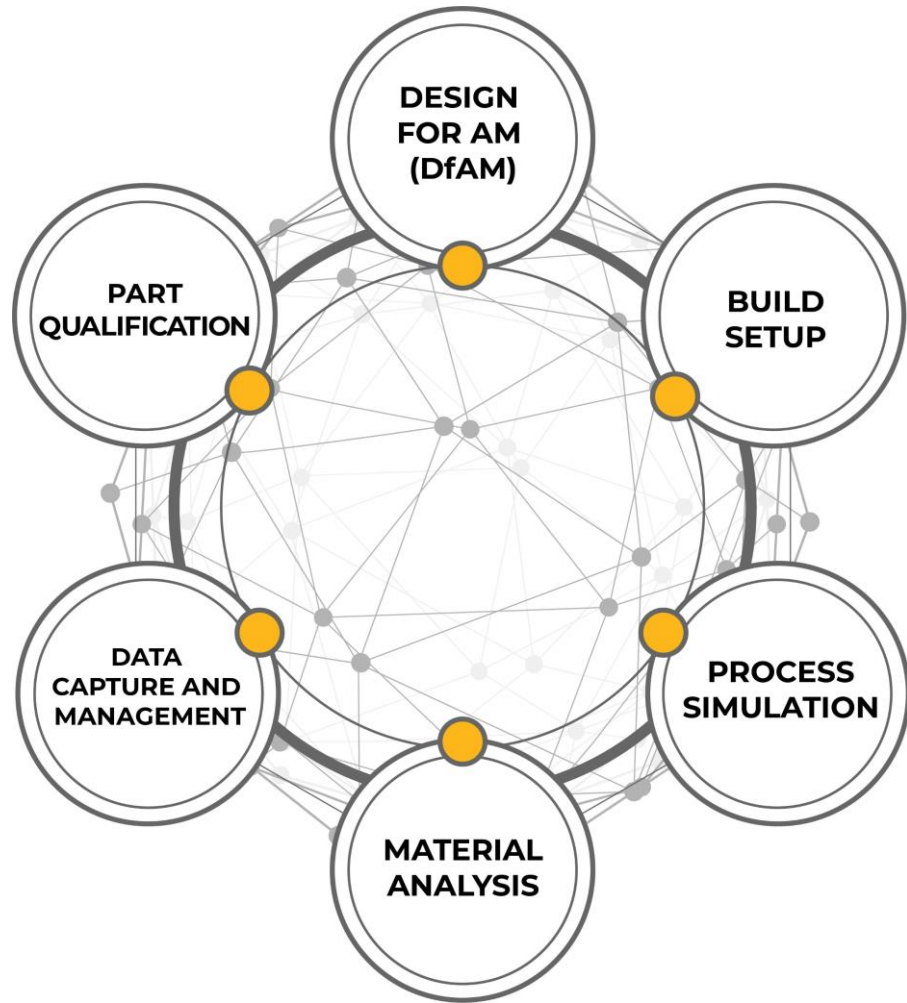

/ Design for AM (DfAM)

- CAD Modeling
- Topology Optimization
- Lattice and Light weighting

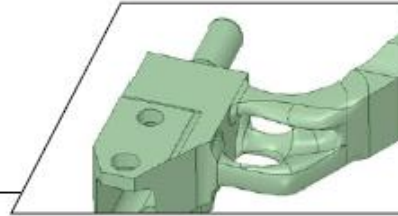

/ Build Setup

- STL File Repair and Geometry Manipulation
- Part Nesting and Support Generation
- Orientation Guidance and Wizards

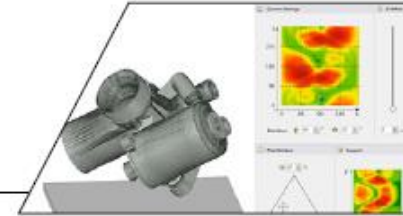

/ Process Simulation

- Metal AM Process Simulations
- Distortion Compensation
- Build Failure Prediction

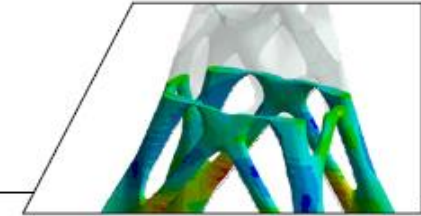

/ Material Analysis

- Curated Material Property Databases
- Grain Morphology Predictions
- Melt pool and Porosity Prediction

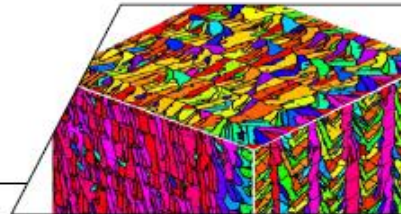

/ Data Acquisition and Management

- Traceability and full control of AM Data
- Consolidate, control and share AM data across organization

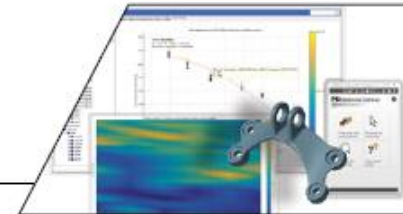

/ Part Qualification

- Design Validation
- Structural and Thermal Analysis
- Document control and Certification

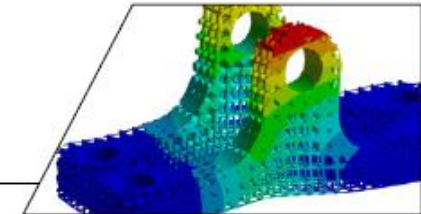

Adjacencies - Ansys Digital Twin Key Capabilities

Predictive/Prescriptive Maintenance



CONNECT the TWINS to IIoT Platforms and **DEPLOY** TWIN Run times in **OPERATION**

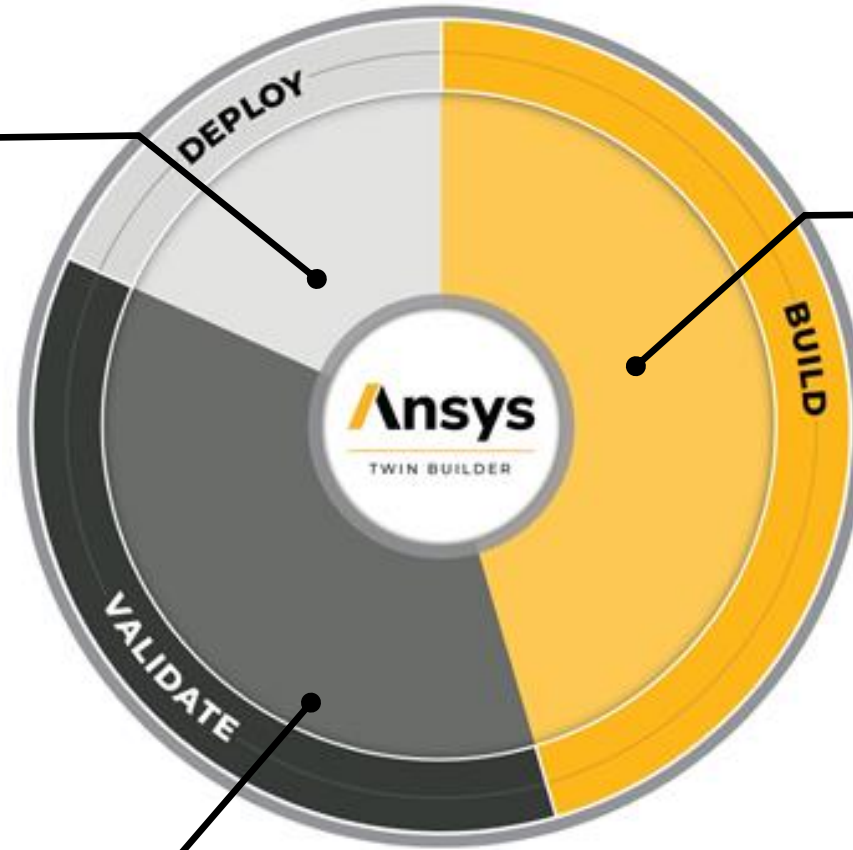

System Simulation



BUILD an accurate **Physics-Based DIGITAL TWIN** in record time

System Validation & Optimization

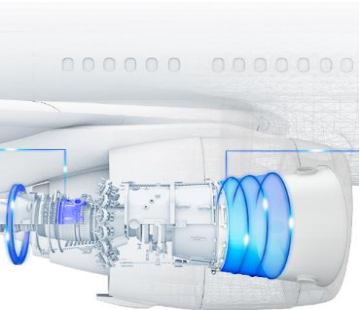

CALIBRATE, VALIDATE and **OPTIMIZE** the TWINS

Digital Twin Partners



What is a Digital Twin?

Past, Present, Future, Simulate!

Virtual representation of real-world entities and processes, synchronized at a specified frequency and fidelity

Track the past, provide deeper insights into the present, predict and influence future behavior

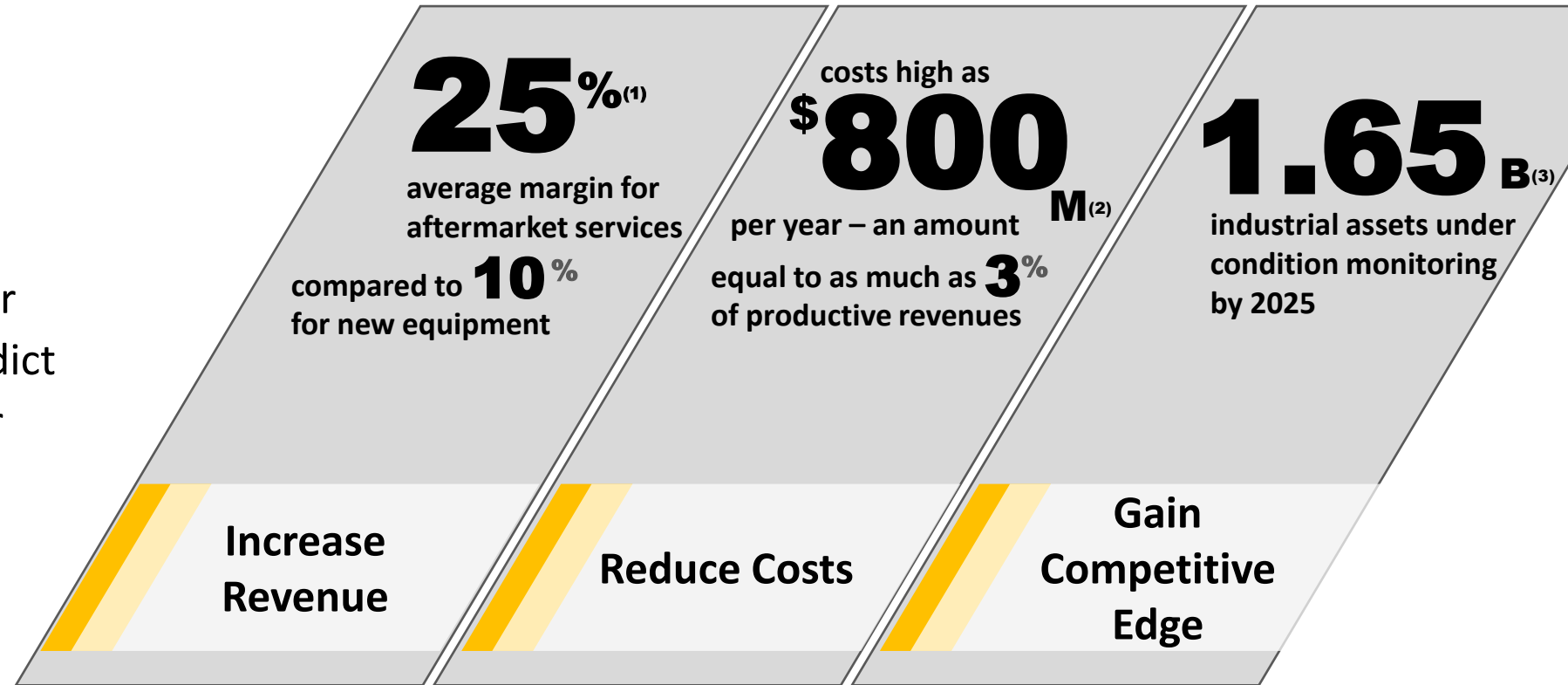

Sources:

1. "Industrial aftermarket services: Growing the core," McKinsey.com. <https://www.mckinsey.com/industries/advanced-electronics/our-insights/industrial-aftermarket-services-growing-the-core>.
2. "Controlling Warranty Costs by Preventing No Fault Found," WIKA Group. https://www.wika.us/upload/BR_MH_3_Challenger_en_us_72394.pdf.
3. Total addressable market (TAM) and compound annual growth rate (CAGR) information throughout presentation is based on third party study completed by Evalueserve Inc. in 2019 commissioned by ANSYS. Study was based on customer and industry expert interviews and review of industry analyst reports and commentaries. Refer to Cautionary Statement for a discussion of factors that could impact future financial results. https://s24.q4cdn.com/308583981/files/doc_downloads/doc_events/sin-min-yap-investor-day-deck.pdf.

Well Positioned in a Growing Market



**ANSYS IS THE
SIMULATION
MARKET LEADER**

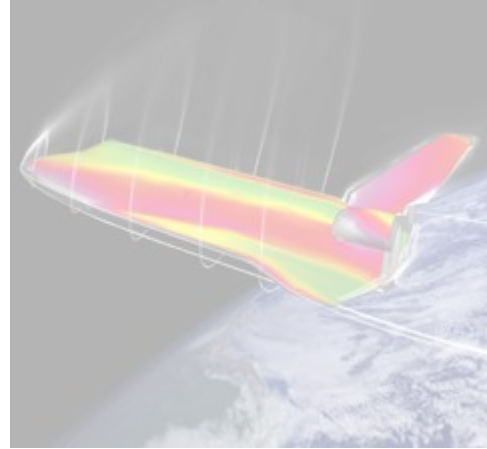

**THE SIMULATION
MARKET IS STRONG
AND GROWING**

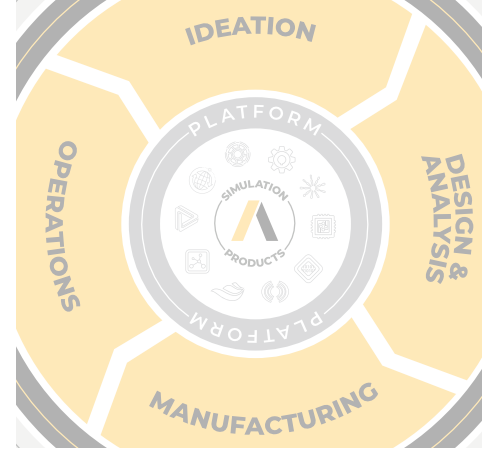

**OUR STRATEGY
CAPITALIZES ON
THIS GROWING
MARKET**



**WE HAVE A
PROVEN RECORD
OF EXECUTION**

Our Go-To-Market has Changed to Deliver Greater Customer Success



Enterprise

80+ Accounts

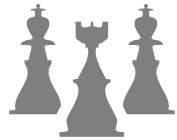

Strategic

100s of Accounts

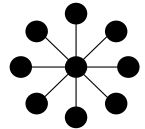

Volume

1000s of Accounts

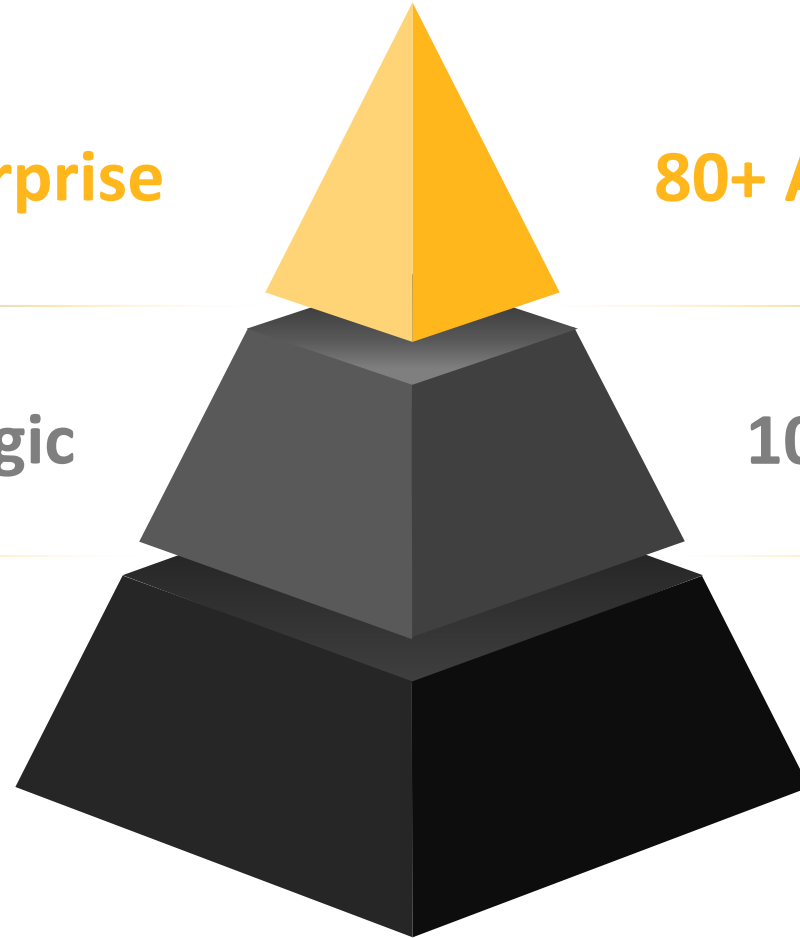

Reinforce and Extend Leadership in the Core

Each of the 80+ enterprise accounts offer strong growth opportunities

U.S. Multinational Case Example

- Strong growth as enterprise account
 - Increased usage
 - Multiphysics
- Large electrification opportunity

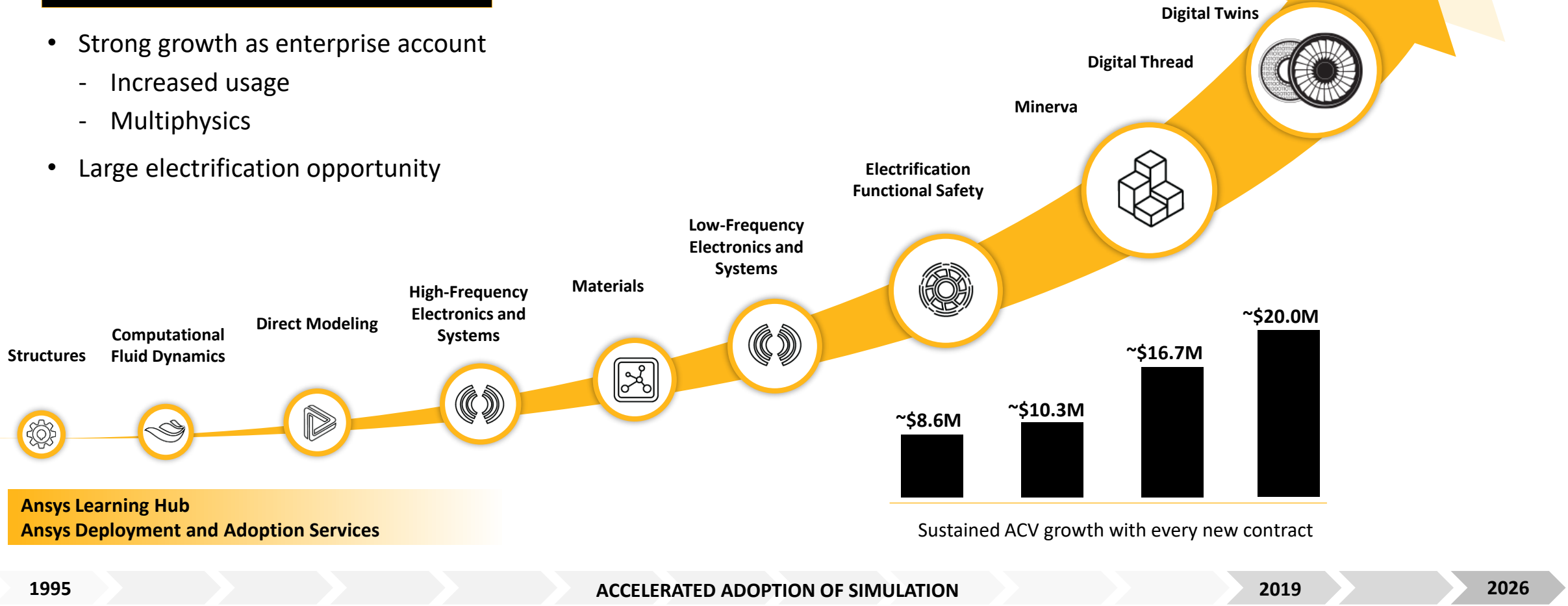

Ansyes Learning Hub
Ansyes Deployment and Adoption Services

Sustained ACV growth with every new contract

1995

ACCELERATED ADOPTION OF SIMULATION

2019

2026



Continued Delivery on Strategy Through Disciplined Execution

- 1 Reinforce and Extend Leadership in the Core**
- 2 Capture Upside in High-Potential Adjacencies**
- 3 Programmatically Pursue Strategic Acquisitions**
- 4 Forge Partnerships to Embed Ansys into Other Ecosystems**
- 5 Build a Winning Culture, the right way**



Executing on Our Growth Strategy



**Performance
Across Key Metrics**



**Diversified and
Resilient Business**



Capital Allocation



Financial Outlook

Key Highlights – Q4 2020

Non-GAAP Financial Highlights

| | |
|-----------------------------|-----------------|
| Revenue | \$627.8M |
| Operating Margin | 51.6% |
| Tax rate | 19.5% |
| Diluted EPS | \$2.96 |
| Annual Contract Value (ACV) | \$665.5M |

See Reconciliation of Non-GAAP financial metrics in Appendix.

Strong Annual Contract Value – FY 2020

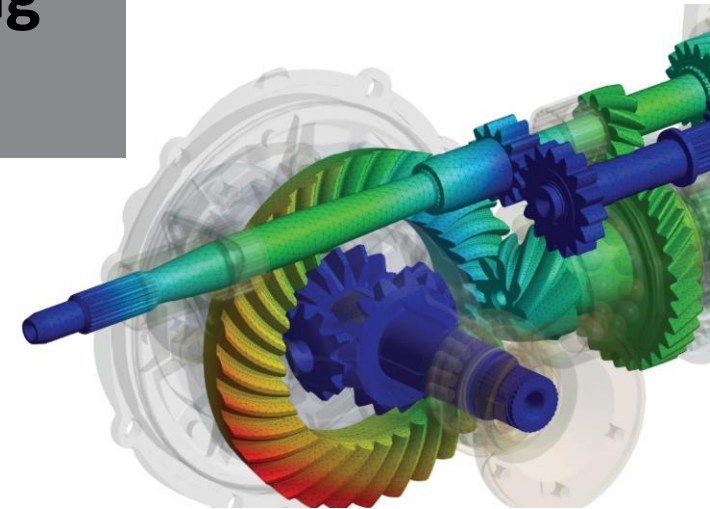
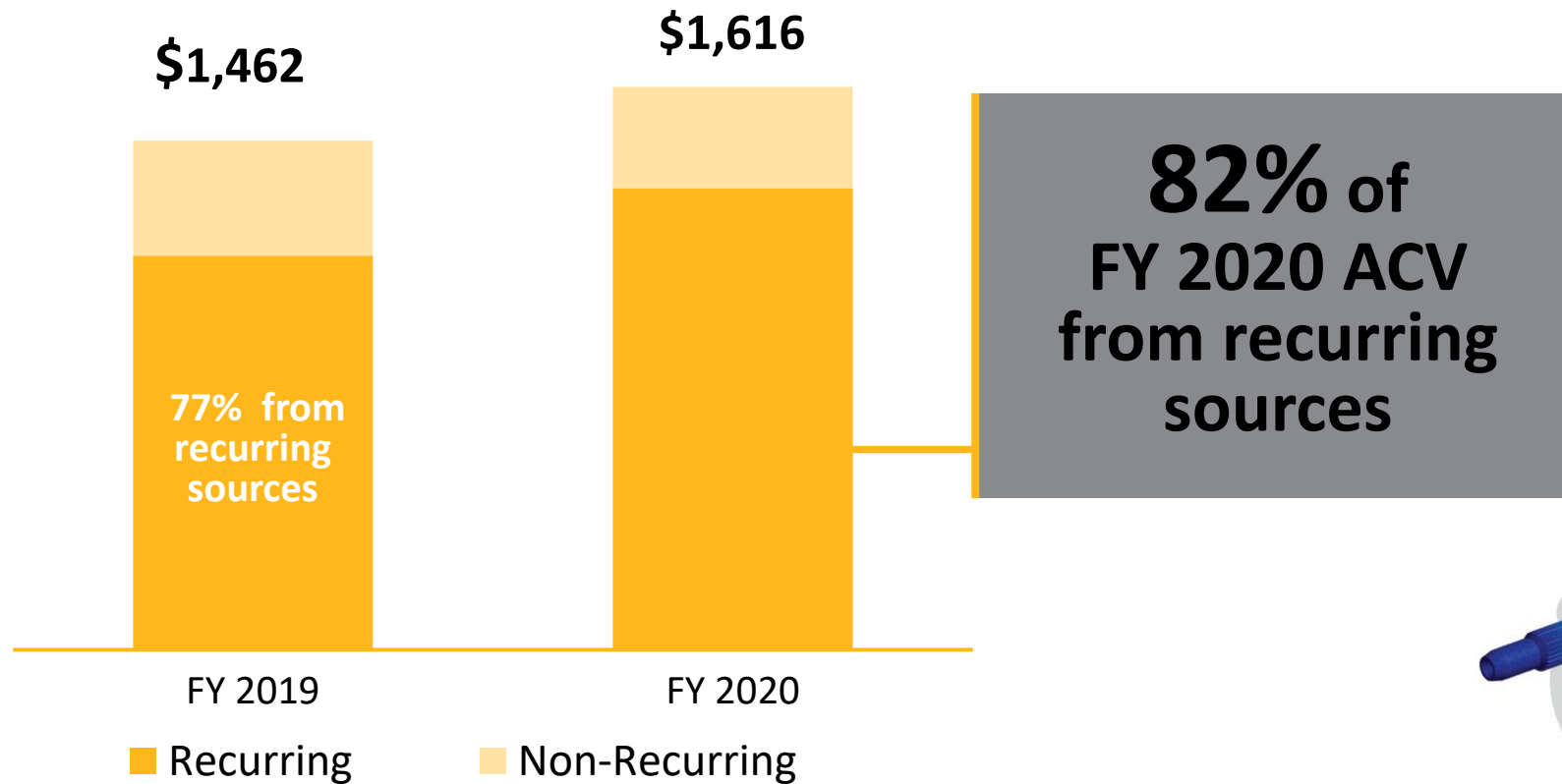

Non-GAAP – Fiscal Year

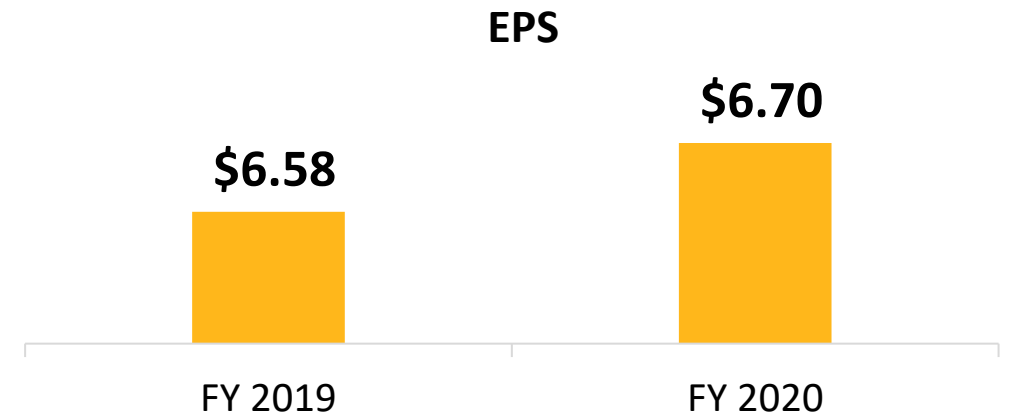
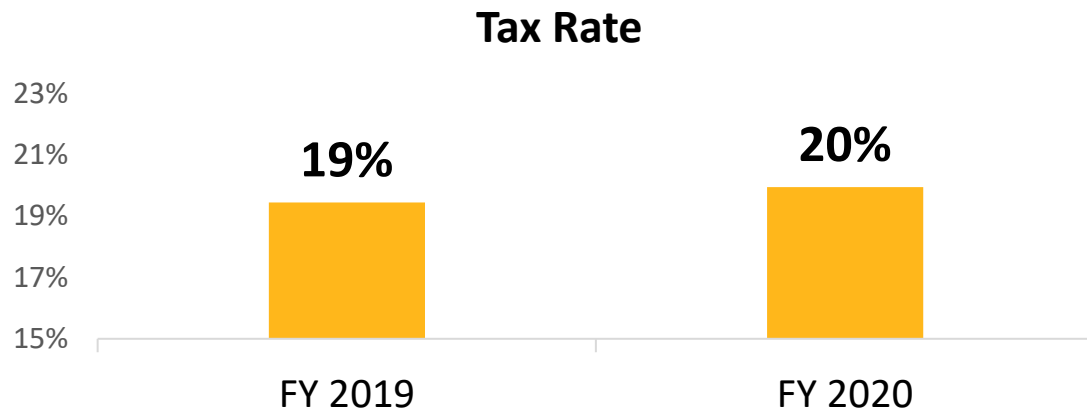
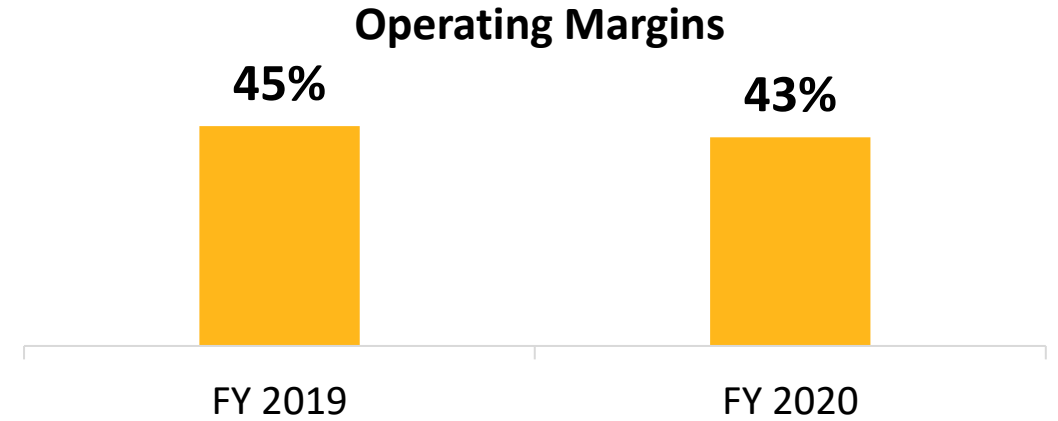
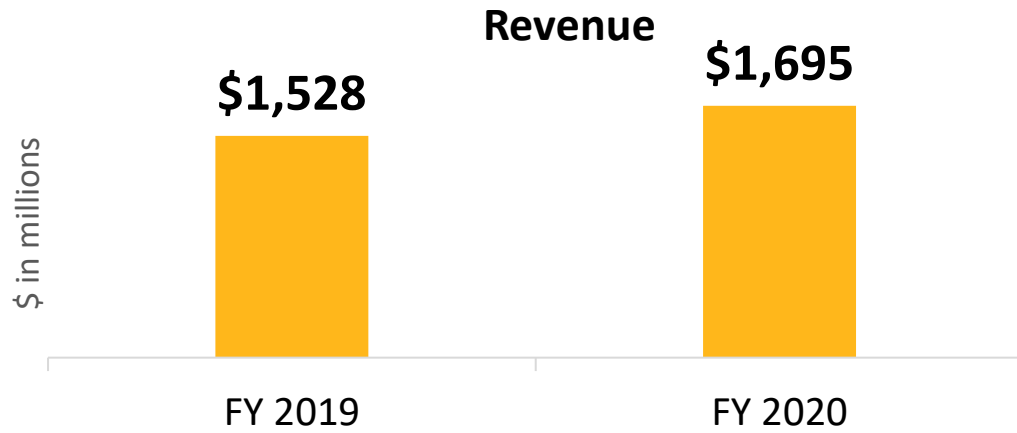

See Reconciliation of Non-GAAP financial metrics in Appendix.



Diverse Customer Base

Non-GAAP Revenue by Geography

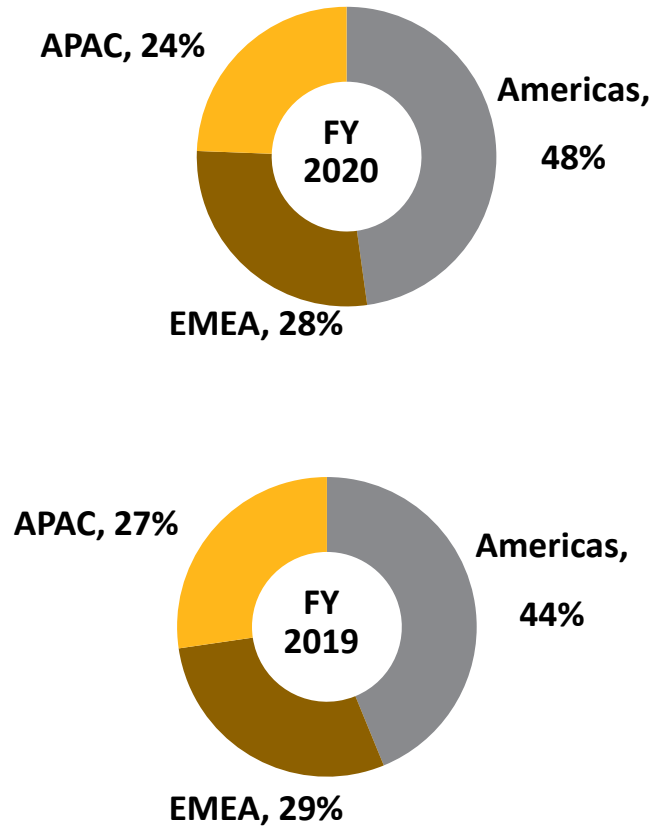

FY 2020 Trailing Twelve-Month ACV by Industry

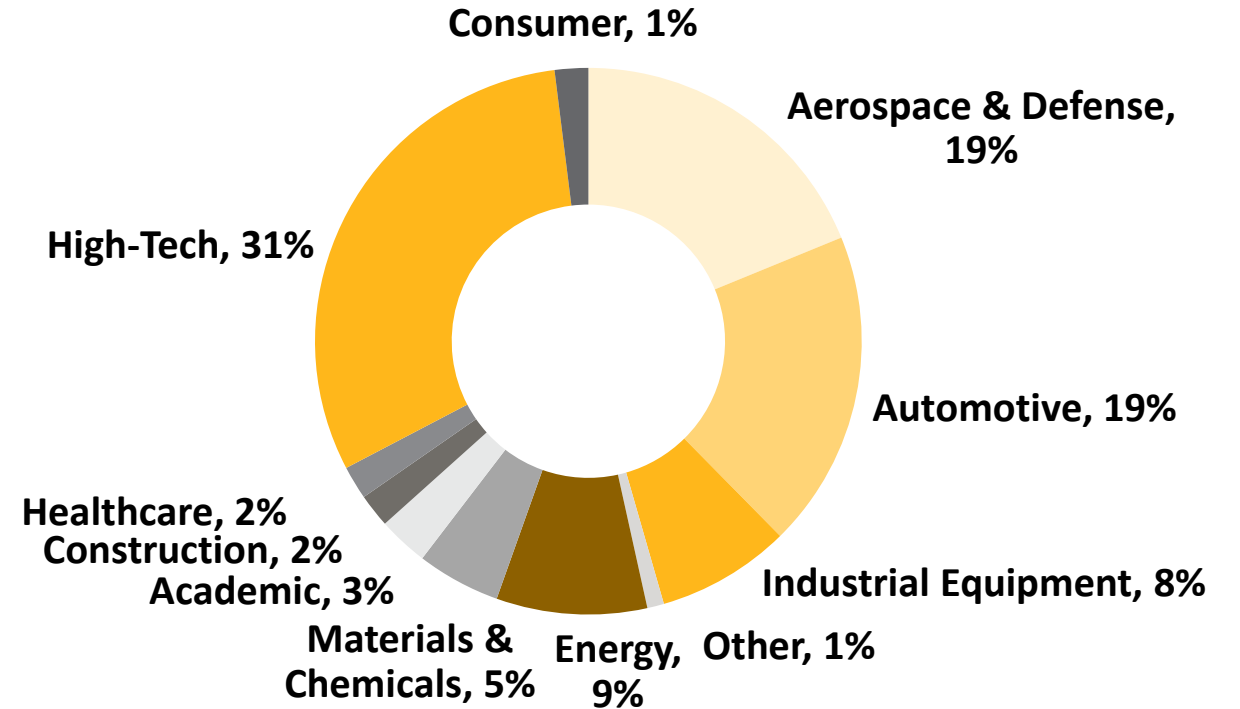

Diverse Revenue Sources – FY 2020

Lease & Maintenance Revenue

(Revenue by Type - Non-GAAP)
(\$ Million)

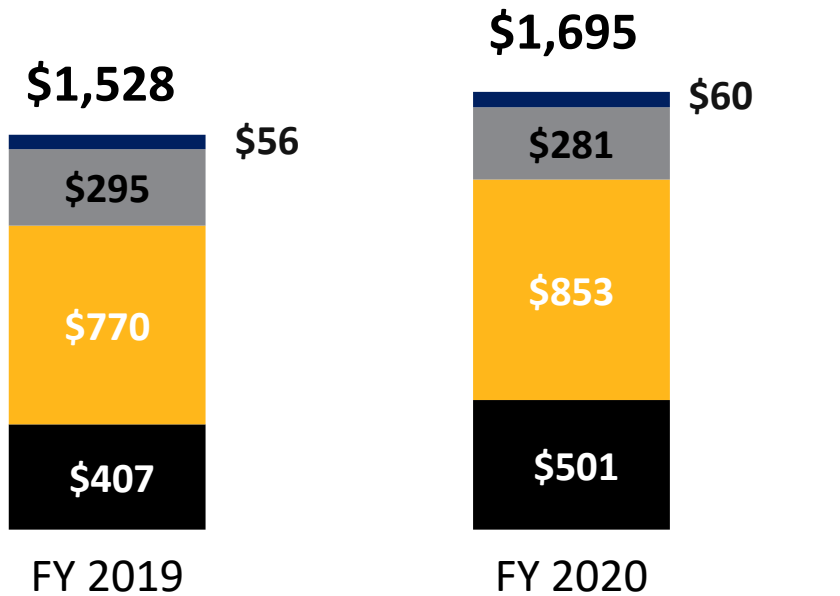

■ Lease ■ Maintenance ■ Perpetual ■ Service

(Revenue as a % of Total - Non-GAAP)

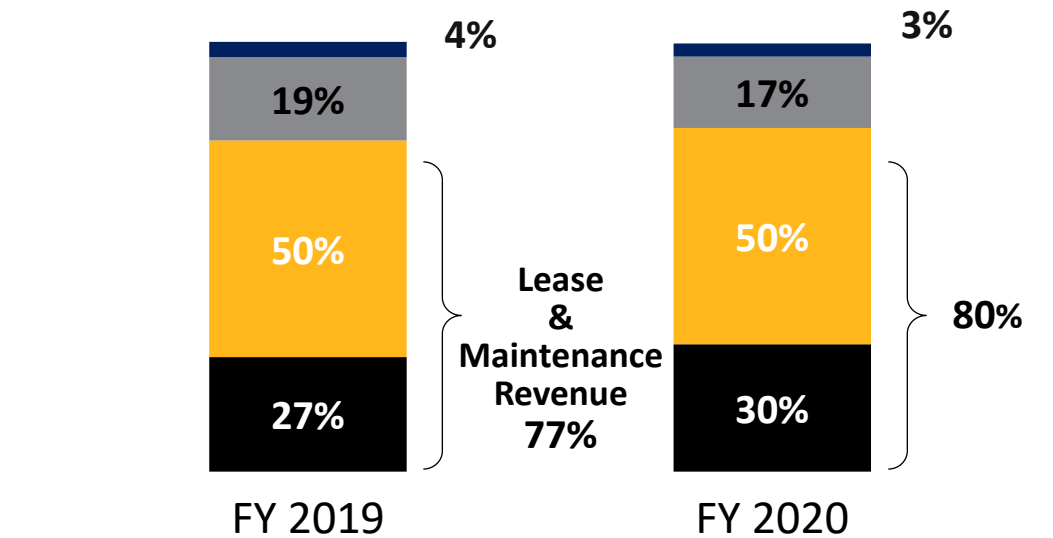

■ Lease ■ Maintenance ■ Perpetual ■ Service

Diverse Go-to-Market Revenue – FY 2020

Non-GAAP Revenue by Channel (% of Total Revenue)

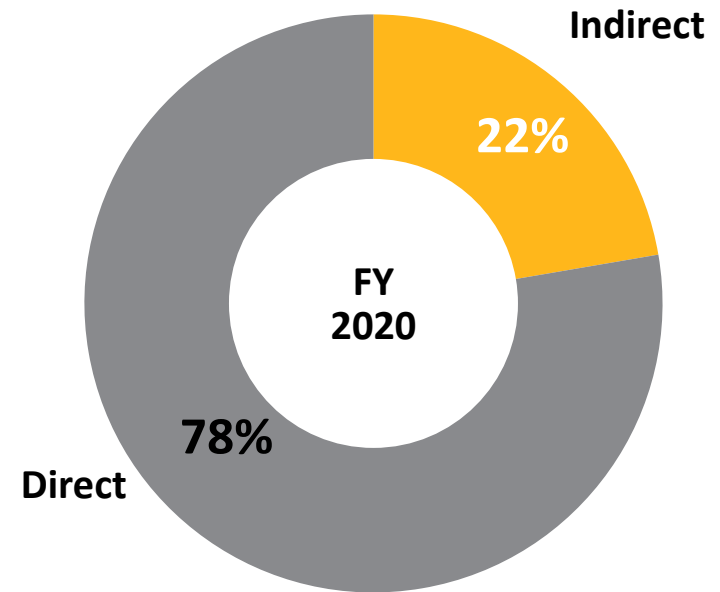
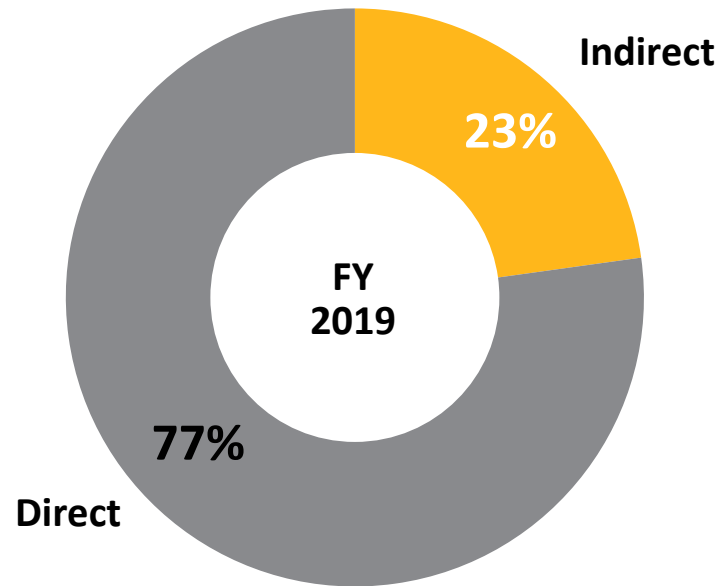

/ Maintaining Strong Financials

Maintaining a Strong Balance Sheet

| As of December 31, 2020 | |
|-------------------------------|---------------|
| Cash & short-term investments | \$913M |
| Deferred revenue & backlog | \$967M |
| Long-term debt | \$798M |

Delivering Strong Y-O-Y Deferred Revenue and Backlog Growth

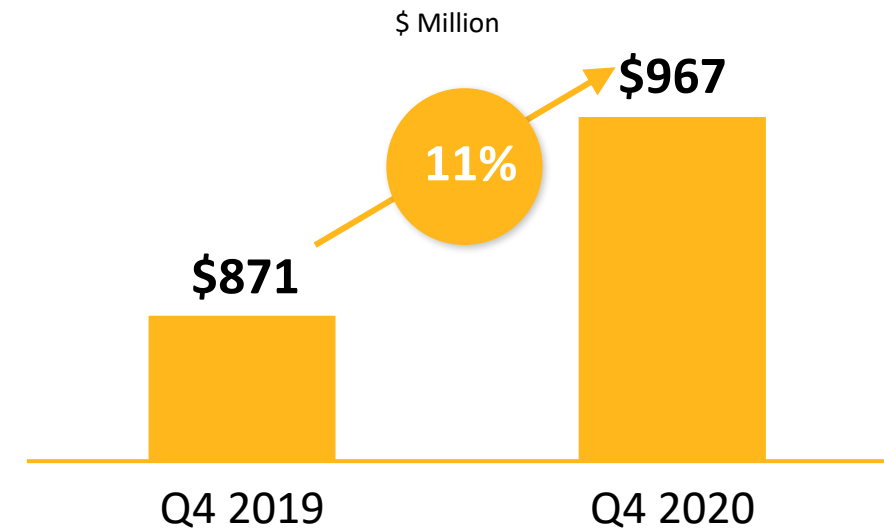

Includes both current and long-term deferred revenue and backlog.

Capital Allocation Framework

Invest in Organic Growth

- Strategic R&D investment
- Expand field engineering
- Digital transformation and infrastructure build-out

Invest in M&A to Enhance Growth

- Targeted acquisitions
- Leverage cross-selling
- Broaden simulation portfolio and expand TAM

Return Capital to Shareholders

- Maintain a focused repurchasing plan

Return of Excess Capital to Stockholders

- We repurchased 0.7 million shares during Q1 2020 at an average price of \$233.48 per share. There were no repurchases in Q2, Q3 and Q4 2020.

Targeted M&A to Broaden Simulation Portfolio and Expand TAM

Key Criteria

Strategic Alignment

- Technology alignment considerations
- Gain top talent
- Go-to-market strategy



Growth

- Expand TAM into new markets
- Access to new customers
- Leverage cross-selling



Cultural Fit

- Passion for technology
- Commitment to excellence
- Strong customer relationships



Selectively investing in value-creating opportunities

Financial Outlook – Q1 2021 & FY 2021

| | Q1 2021 GAAP | Q1 2021 Non-GAAP |
|--------------------|--------------------|---------------------|
| Revenue | \$326.0 - \$351.0M | \$335.0 - \$360.0M |
| Operating Margin | 1.9% - 8.7% | 24.0% - 27.5% |
| Effective Tax Rate | (1) See Footnote | 19.0% |
| Diluted EPS | \$0.41 - \$0.57 | \$0.73 - \$0.90 |

| | FY 2021 GAAP | FY 2021 Non-GAAP |
|--------------------|------------------------|------------------------|
| Revenue | \$1,770.5 - \$1,855.5M | \$1,790.0 - \$1,875.0M |
| Operating Margin | 25.1% - 27.8% | 40.0% - 41.0% |
| Effective Tax Rate | 12.0% - 14.5% | 19.0% |
| Diluted EPS | \$4.33 - \$4.86 | \$6.44 - \$6.92 |

| | FY 2021 |
|-----------------------------|------------------------|
| Annual Contract Value (ACV) | \$1,750.0 - \$1,825.0M |
| Operating Cash Flows | \$475.0 - \$515.0M |

(1) The expected GAAP effective tax rate is not meaningful in the first quarter of 2021 as a result of significant anticipated excess tax benefits associated with stock awards. Guidance as of February 24, 2021. Any usage of slide on a subsequent date does not constitute guidance re-confirmation as of such subsequent date. Refer to Cautionary Statement for a discussion of factors that could cause actual results to differ materially from outlook.

Provided 2019 Investor Day - The Growth Story Continues to 2022: Marching Towards \$2B ACV and Investing Selectively

ACV

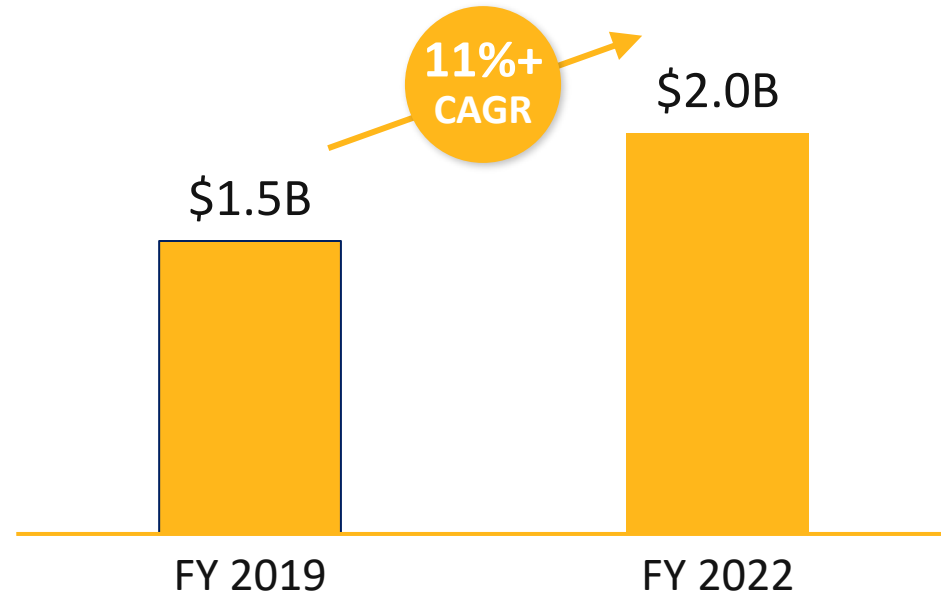

Marching Toward \$2 Billion!

- Continued execution on Pervasive Simulation strategy
- Capitalize on emerging high-growth solutions
- Invest in world-class customer-facing expertise
- Includes impact of “tuck-in” acquisitions

Operating Margins
(Non-GAAP)

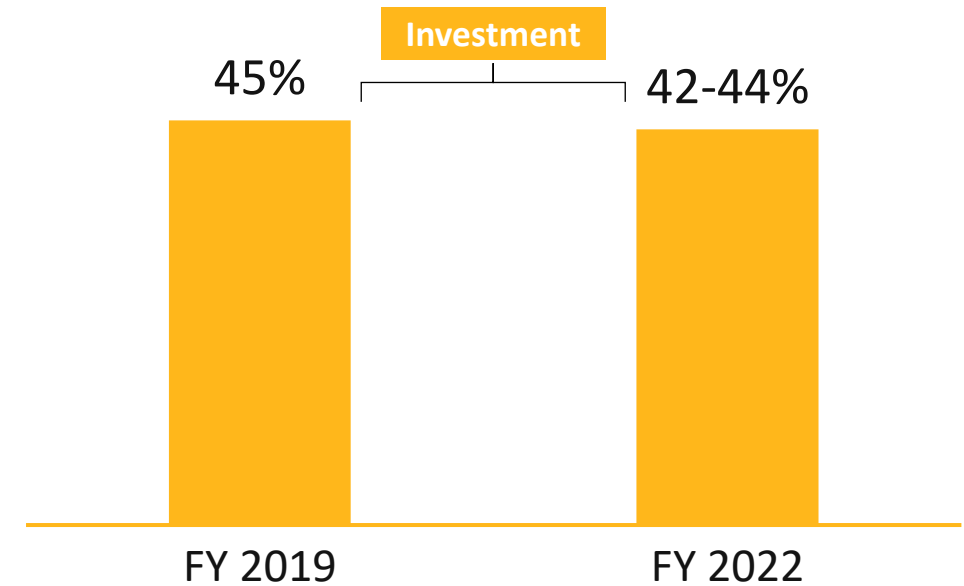

Investing in the Business

- Slight dilution from M&A
- Ongoing infrastructure and digital transformation investments

Appendix

Non-GAAP Measures

We provide non-GAAP revenue, non-GAAP gross profit, non-GAAP gross profit margin, non-GAAP operating income, non-GAAP operating profit margin, non-GAAP net income and non-GAAP diluted earnings per share as supplemental measures to GAAP regarding our operational performance. These financial measures exclude the impact of certain items and, therefore, have not been calculated in accordance with GAAP. A detailed explanation of each of the adjustments to such financial measures is described below. This presentation also contains a reconciliation of each of these non-GAAP financial measures to its most comparable GAAP financial measure.

We use non-GAAP financial measures (a) to evaluate our historical and prospective financial performance as well as our performance relative to our competitors, (b) to set internal sales targets and spending budgets, (c) to allocate resources, (d) to measure operational profitability and the accuracy of forecasting, (e) to assess financial discipline over operational expenditures and (f) as an important factor in determining variable compensation for management and employees. In addition, many financial analysts that follow us focus on and publish both historical results and future projections based on non-GAAP financial measures. We believe that it is in the best interest of our investors to provide this information to analysts so that they accurately report the non-GAAP financial information. Moreover, investors have historically requested, and we have historically reported, these non-GAAP financial measures as a means of providing consistent and comparable information with past reports of financial results.

While we believe that these non-GAAP financial measures provide useful supplemental information to investors, there are limitations associated with the use of these non-GAAP financial measures. These non-GAAP financial measures are not prepared in accordance with GAAP, are not reported by all our competitors and may not be directly comparable to similarly titled measures of our competitors due to potential differences in the exact method of calculation. We compensate for these limitations by using these non-GAAP financial measures as supplements to GAAP financial measures and by reviewing the reconciliations of the non-GAAP financial measures to their most comparable GAAP financial measures.

The adjustments to these non-GAAP financial measures, and the basis for such adjustments, are outlined below:

Acquisition accounting for deferred revenue. Historically, we have consummated acquisitions in order to support our strategic and other business objectives. In accordance with the fair value provisions applicable to the accounting for business combinations, acquired deferred revenue is often recorded on the opening balance sheet at an amount that is lower than the historical carrying value. Although this acquisition accounting requirement has no impact on our business or cash flow, it adversely impacts our reported GAAP revenue in the reporting periods following an acquisition. In order to provide investors with financial information that facilitates comparison of both historical and future results, we provide non-GAAP financial measures which exclude the impact of the acquisition accounting adjustment. We believe that this non-GAAP financial adjustment is useful to investors because it allows investors to (a) evaluate the effectiveness of the methodology and information used by us in our financial and operational decision-making, and (b) compare our past and future reports of financial results as the revenue reduction related to acquired deferred revenue will not recur when related lease licenses and software maintenance contracts are renewed in future periods.

Non-GAAP Measures

Amortization of intangible assets from acquisitions. We incur amortization of intangible assets, included in our GAAP presentation of amortization expense, related to various acquisitions we have made. We exclude these expenses for the purpose of calculating non-GAAP gross profit, non-GAAP gross profit margin, non-GAAP operating income, non-GAAP operating profit margin, non-GAAP net income and non-GAAP diluted earnings per share when we evaluate our continuing operational performance because these costs are fixed at the time of an acquisition, are then amortized over a period of several years after the acquisition and generally cannot be changed or influenced by us after the acquisition. Accordingly, we do not consider these expenses for purposes of evaluating our performance during the applicable time period after the acquisition, and we exclude such expenses when making decisions to allocate resources. We believe that these non-GAAP financial measures are useful to investors because they allow investors to (a) evaluate the effectiveness of the methodology and information used by us in our financial and operational decision-making, and (b) compare our past reports of financial results as we have historically reported these non-GAAP financial measures.

Stock-based compensation expense. We incur expense related to stock-based compensation included in our GAAP presentation of cost of maintenance and service; research and development expense; and selling, general and administrative expense. This non-GAAP adjustment also includes excess payroll tax expense related to stock-based compensation. Stock-based compensation expense (benefit) incurred in connection with our deferred compensation plan held in a rabbi trust includes an offsetting benefit (charge) recorded in other income (expense). Although stock-based compensation is an expense and viewed as a form of compensation, we exclude these expenses for the purpose of calculating non-GAAP gross profit, non-GAAP gross profit margin, non-GAAP operating income, non-GAAP operating profit margin, non-GAAP net income and non-GAAP diluted earnings per share when we evaluate our continuing operational performance. We similarly exclude income (expense) related to assets held in a rabbi trust in connection with our deferred compensation plan. Specifically, we exclude stock-based compensation and income (expense) related to assets held in the deferred compensation plan rabbi trust during our annual budgeting process and our quarterly and annual assessments of our performance. The annual budgeting process is the primary mechanism whereby we allocate resources to various initiatives and operational requirements. Additionally, the annual review by our board of directors during which it compares our historical business model and profitability to the planned business model and profitability for the forthcoming year excludes the impact of stock-based compensation. In evaluating the performance of our senior management and department managers, charges related to stock-based compensation are excluded from expenditure and profitability results. In fact, we record stock-based compensation expense into a stand-alone cost center for which no single operational manager is responsible or accountable. In this way, we can review, on a period-to-period basis, each manager's performance and assess financial discipline over operational expenditures without the effect of stock-based compensation. We believe that these non-GAAP financial measures are useful to investors because they allow investors to (a) evaluate our operating results and the effectiveness of the methodology used by us to review our operating results, and (b) review historical comparability in our financial reporting as well as comparability with competitors' operating results.

Transaction expenses related to business combinations. We incur expenses for professional services rendered in connection with business combinations, which are included in our GAAP presentation of selling, general and administrative expense. These expenses are generally not tax-deductible. We exclude these acquisition-related transaction expenses, derived from announced acquisitions, for the purpose of calculating non-GAAP operating income, non-GAAP operating profit margin, non-GAAP net income and non-GAAP diluted earnings per share when we evaluate our continuing operational performance, as we generally would not have otherwise incurred these expenses in the periods presented as a part of our operations. We believe that these non-GAAP financial measures are useful to investors because they allow investors to (a) evaluate our operating results and the effectiveness of the methodology used by us to review our operating results, and (b) review historical comparability in our financial reporting as well as comparability with competitors' operating results.

Non-GAAP Measures

Tax Cuts and Jobs Act. We recorded impacts to our income tax provision related to the enactment of the Tax Cuts and Jobs Act of 2017, specifically for the transition tax related to unrepatriated cash. We exclude these impacts for the purpose of calculating non-GAAP net income and non-GAAP diluted earnings per share when we evaluate our continuing operational performance, as (i) the charges are not expected to recur as part of our normal operations and (ii) the charges resulted from the extremely infrequent event of major U.S. tax reform, the last such reform having occurred in 1986. We believe that these non-GAAP financial measures are useful to investors because they allow investors to (a) evaluate our operating results and the effectiveness of the methodology used by us to review our operating results, and (b) review historical comparability in our financial reporting.

Non-GAAP tax provision. We utilize a normalized non-GAAP annual effective tax rate (AETR) to calculate non-GAAP measures. This methodology provides better consistency across interim reporting periods by eliminating the effects of non-recurring items and aligning the non-GAAP tax rate with our expected geographic earnings mix. To project this rate, we analyzed our historic and projected non-GAAP earnings mix by geography along with other factors such as our current tax structure, recurring tax credits and incentives, and expected tax positions. On an annual basis we will re-evaluate this rate for significant items that may materially affect our projections.

Non-GAAP financial measures are not in accordance with, or an alternative for, GAAP. Our non-GAAP financial measures are not meant to be considered in isolation or as a substitute for comparable GAAP financial measures and should be read only in conjunction with our consolidated financial statements prepared in accordance with GAAP.

We have provided a reconciliation of the non-GAAP financial measures to the most directly comparable GAAP financial measures as listed below:

GAAP Reporting Measure

Revenue
Gross Profit
Gross Profit Margin
Operating Income
Operating Profit Margin
Net Income
Diluted Earnings Per Share

Non-GAAP Reporting Measure

Non-GAAP Revenue
Non-GAAP Gross Profit
Non-GAAP Gross Profit Margin
Non-GAAP Operating Income
Non-GAAP Operating Profit Margin
Non-GAAP Net Income
Non-GAAP Diluted Earnings Per Share

ANSYS, INC. AND SUBSIDIARIES Reconciliation of Non-GAAP Measures (Unaudited)

| <i>(in thousands, except percentages and per share data)</i> | Three Months Ended December 31, 2020 | | | | | | |
|--|---|-------------------|---------------|---------------------|---------------|-------------------|----------------------------|
| | Revenue | Gross Profit | % | Operating Income | % | Net Income | EPS - Diluted ¹ |
| Total GAAP | \$ 623,686 | \$ 555,783 | 89.1 % | \$ 259,391 | 41.6 % | \$ 215,632 | \$ 2.46 |
| Acquisition accounting for deferred revenue | 4,085 | 4,085 | 0.1 % | 4,085 | 0.4 % | 4,085 | 0.05 |
| Stock-based compensation expense | — | 3,670 | 0.6 % | 42,359 | 6.7 % | 42,359 | 0.47 |
| Excess payroll taxes related to stock-based awards | — | 39 | — % | 520 | 0.1 % | 520 | 0.01 |
| Amortization of intangible assets from acquisitions | — | 11,415 | 1.8 % | 15,452 | 2.4 % | 15,452 | 0.18 |
| Transaction expenses related to business combinations | — | — | — % | 2,321 | 0.4 % | 2,321 | 0.03 |
| Rabbi trust (income) / expense | — | — | — % | — | — % | (1) | — |
| Adjustment for income tax effect | — | — | — % | — | — % | (20,668) | (0.24) |
| Total non-GAAP | \$ 627,771 | \$ 574,992 | 91.6 % | \$ 324,128 | 51.6 % | \$ 259,700 | \$ 2.96 |

¹ Diluted weighted average shares were 87,626.

ANSYS, INC. AND SUBSIDIARIES Reconciliation of Non-GAAP Measures (Unaudited)

| <i>(in thousands, except percentages and per share data)</i> | Three Months Ended December 31, 2019 | | | | | | |
|--|---|-------------------|---------------|---------------------|---------------|-------------------|----------------------------|
| | Revenue | Gross Profit | % | Operating Income | % | Net Income | EPS - Diluted ¹ |
| Total GAAP | \$ 486,228 | \$ 436,632 | 89.8 % | \$ 185,716 | 38.2 % | \$ 165,852 | \$ 1.91 |
| Acquisition accounting for deferred revenue | 6,265 | 6,265 | 0.1 % | 6,265 | 0.8 % | 6,265 | 0.07 |
| Stock-based compensation expense | — | 2,470 | 0.5 % | 31,406 | 6.4 % | 31,406 | 0.37 |
| Excess payroll taxes related to stock-based awards | — | 42 | — % | 404 | 0.1 % | 404 | — |
| Amortization of intangible assets from acquisitions | — | 7,646 | 1.6 % | 11,473 | 2.3 % | 11,473 | 0.13 |
| Transaction expenses related to business combinations | — | — | — % | 948 | 0.2 % | 948 | 0.01 |
| Rabbi trust (income) / expense | — | — | — % | — | — % | (101) | — |
| Adjustment for income tax effect | — | — | — % | — | — % | (21,534) | (0.25) |
| Total non-GAAP | \$ 492,493 | \$ 453,055 | 92.0 % | \$ 236,212 | 48.0 % | \$ 194,713 | \$ 2.24 |

¹ Diluted weighted average shares were 86,992.

ANSYS, INC. AND SUBSIDIARIES
Reconciliation of Non-GAAP Measures
(Unaudited)

| <i>(in thousands, except percentages and per share data)</i> | Twelve Months Ended | | | | | | |
|--|---------------------|---------------------|---------------|-------------------|---------------|-------------------|----------------------------|
| | December 31, 2020 | | | | | | |
| | Revenue | Gross Profit | % | Operating Income | % | Net Income | EPS - Diluted ¹ |
| Total GAAP | \$ 1,681,297 | \$ 1,456,033 | 86.6 % | \$ 496,356 | 29.5 % | \$ 433,887 | \$ 4.97 |
| Acquisition accounting for deferred revenue | 14,201 | 14,201 | 0.1 % | 14,201 | 0.6 % | 14,201 | 0.16 |
| Stock-based compensation expense | — | 13,626 | 0.8 % | 145,615 | 8.6 % | 145,615 | 1.66 |
| Excess payroll taxes related to stock-based awards | — | 813 | 0.1 % | 10,111 | 0.6 % | 10,111 | 0.12 |
| Amortization of intangible assets from acquisitions | — | 40,642 | 2.4 % | 57,241 | 3.4 % | 57,241 | 0.66 |
| Transaction expenses related to business combinations | — | — | — % | 5,129 | 0.3 % | 5,129 | 0.06 |
| Rabbi trust (income) / expense | — | — | — % | — | — % | (6) | — |
| Adjustment for income tax effect | — | — | — % | — | — % | (81,574) | (0.93) |
| Total non-GAAP | \$ 1,695,498 | \$ 1,525,315 | 90.0 % | \$ 728,653 | 43.0 % | \$ 584,604 | \$ 6.70 |

¹ Diluted weighted average shares were 87,288.

ANSYS, INC. AND SUBSIDIARIES Reconciliation of Non-GAAP Measures (Unaudited)

| <i>(in thousands, except percentages and per share data)</i> | Twelve Months Ended December 31, 2019 | | | | | | |
|--|--|---------------------|---------------|-------------------|---------------|-------------------|----------------------------|
| | Revenue | Gross Profit | % | Operating Income | % | Net Income | EPS - Diluted ¹ |
| Total GAAP | \$ 1,515,892 | \$ 1,349,619 | 89.0 % | \$ 515,040 | 34.0 % | \$ 451,295 | \$ 5.25 |
| Acquisition accounting for deferred revenue | 12,514 | 12,514 | 0.1 % | 12,514 | 0.5 % | 12,514 | 0.15 |
| Stock-based compensation expense | — | 8,494 | 0.5 % | 116,190 | 7.7 % | 116,190 | 1.34 |
| Excess payroll taxes related to stock-based awards | — | 518 | 0.1 % | 4,920 | 0.3 % | 4,920 | 0.06 |
| Amortization of intangible assets from acquisitions | — | 21,710 | 1.4 % | 36,879 | 2.4 % | 36,879 | 0.43 |
| Transaction expenses related to business combinations | — | — | — % | 6,590 | 0.4 % | 6,590 | 0.08 |
| Rabbi trust (income) / expense | — | — | — % | — | — % | (369) | — |
| Adjustment related to the Tax Cuts and Jobs Act | — | — | — % | — | — % | (1,834) | (0.02) |
| Adjustment for income tax effect | — | — | — % | — | — % | (61,188) | (0.71) |
| Total non-GAAP | \$ 1,528,406 | \$ 1,392,855 | 91.1 % | \$ 692,133 | 45.3 % | \$ 564,997 | \$ 6.58 |

¹ Diluted weighted average shares were 85,925.

ANSYS, INC. AND SUBSIDIARIES
Reconciliation of Forward-Looking Guidance
Quarter Ending March 31, 2021

| | Earnings Per Share - Diluted |
|---|-------------------------------------|
| U.S. GAAP expectation | \$0.41 - \$0.57 |
| Exclusions before tax: | |
| Acquisition adjustments to deferred revenue | \$0.10 |
| Acquisition-related amortization | \$0.22 |
| Stock-based compensation and related excess payroll tax | \$0.46 - \$0.52 |
| Adjustment for income tax effect | (\$0.45) - (\$0.52) |
| Non-GAAP expectation | \$0.73 - \$0.90 |

ANSYS, INC. AND SUBSIDIARIES
Reconciliation of Forward-Looking Guidance
Year Ending December 31, 2021

| | Earnings Per Share - Diluted |
|---|-------------------------------------|
| U.S. GAAP expectation | \$4.33 - \$4.86 |
| Exclusions before tax: | |
| Acquisition adjustments to deferred revenue | \$0.22 |
| Acquisition-related amortization | \$0.83 - \$0.86 |
| Stock-based compensation and related excess payroll tax | \$1.80 - \$1.96 |
| Adjustment for income tax effect | (\$0.79) - (\$0.93) |
| Non-GAAP expectation | \$6.44 - \$6.92 |

Annual Contract Value (ACV)

ANNUAL CONTRACT VALUE (ACV) METRIC

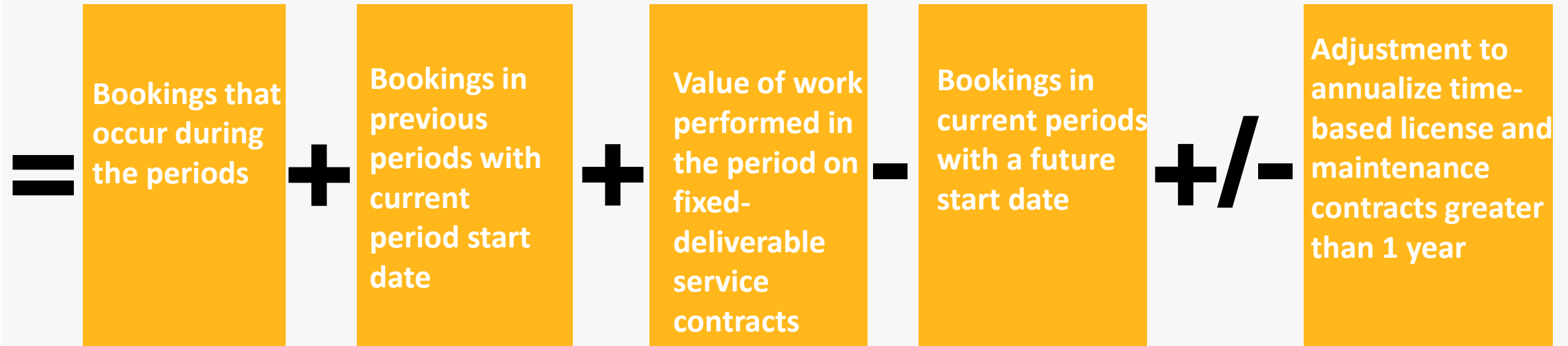

- ACV is one of our key performance metrics and is useful to investors in assessing the strength and trajectory of our business. Given that revenue is variable due to the upfront revenue recognition of multi-year lease license sales, we provide ACV as a supplemental metric to help evaluate the annual performance of the business.
- ACV should be viewed independently of revenue and deferred revenue as ACV is a performance metric and is not intended to be combined with any of these items. There is no GAAP measure comparable to ACV.

Annette N. Arribas, IRC
Senior Director, Global Investor Relations Officer
Phone: +1 (724) 820-3700
Email: annette.arribas@ansys.com

Virginea Stuart Gibson
Investor Relations Manager
Phone: +1 (724) 820-4225
Email: virginea.gibson@ansys.com

NASDAQ:ANSS

<https://investors.ansys.com>

