

# ADVANTAGE

Excellence in Engineering Simulation

ISSUE 2 | 2017



## SPOTLIGHT ON **DIGITAL EXPLORATION**

**13 Picking Up Steam**  
Improved steam  
generator performance

**22 Bright Idea**  
Optimized automotive  
headlight

**34 Electrifying Vehicle**  
Multiphysics for  
electric vehicle design

# Your designs are cutting-edge. *Is your IT?*

Scalable, optimized, turnkey cloud simulation



Rescale's cloud simulation platform is backed by the world's largest network of HPC data centers.



Instantly scale out your ANSYS simulations on a broad set of core types, including bare metal and virtual systems, to quickly and efficiently simulate the breadth of physics.

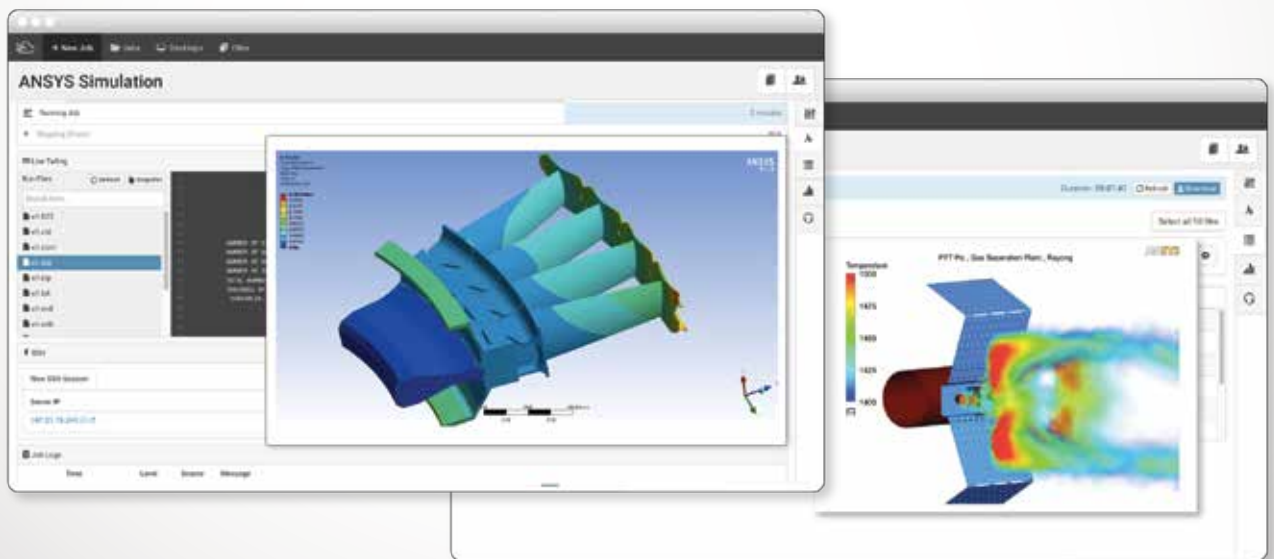

Visit us at [www.rescale.com/ansys18](http://www.rescale.com/ansys18)

# DIGITAL EXPLORATION: THE NEW IMPERATIVE

By applying simulation at the earliest stages of product development, leading companies rapidly explore thousands of design options — creating breakthrough innovations and a significant competitive advantage.



By **Mark Hindsbo**,  
Vice President and  
General Manager, Design  
and Platform Business,  
ANSYS

The positive impact of engineering simulation on the product development process has been well documented. By enabling engineers to test and verify their designs digitally, simulation has cut enormous costs and time from the development cycle, while also enabling innovation.

Over the past 40 years, backed up by thousands of customer success stories, simulation has been established as a key part of the product design verification process. Our experience and independent studies show that upwards of 80 percent of total product cost is determined by decisions made in the earliest stages of the product development process. As the design matures, options are increasingly limited, constraints are placed on the product development team's ability to innovate, and the cost of change becomes exponentially higher.

By applying simulation at the beginning of the design cycle, a product development team can quickly and cost-effectively explore thousands of design variations and gain insight into the impact of the choices made. By posing what-if questions, the team can discard some ideas and focus on the most promising ones. And they can explore options that were previously not even considered due to cost and complexity.

## An Idea Whose Time Has Come

Digital exploration has never been more vital to long-term business success than it is today. The product design space is exploding, driven by increasingly smarter and connected devices, and advanced materials and manufacturing technologies like 3-D printing and mass customization. At the same time, sustainability and cost concerns put pressure on identifying and eliminating overdesign, while still meeting customer expectations. We have an unprecedented opportunity to innovate, but at the cost of managing

product design processes that are orders of magnitude more complex.

Digital exploration is the only way product development teams can possibly handle the need for innovation and the resulting complexity introduced by current market demands. Simulation was once a scarce and a highly specialized resource that was applied sparingly. Now, the barriers that once limited its usage are rapidly falling, and simulation is becoming more pervasive. This allows for unprecedented insight into product performance and trade-off analyses across interrelated design requirements.

By enabling the analysis of a multitude of design options — and by putting this capability in the hands of more engineers — digital exploration supports the extremely innovative product design required to succeed in today's fast-paced, competitive global marketplace.

## Investing in the Future

So that more product developers can benefit from digital exploration, as a key strategic initiative, ANSYS continually

invests in usability, features and capabilities that make simulation easier to adopt for a broader audience.

ANSYS has solutions tailored specifically for the product and design engineer, so every member of the product development team can leverage simulation. No longer is simulation the exclusive domain of specialists: Analysts and non-analysts alike can now work collaboratively using tools that scale to their individual simulation needs and skills. And all are built on the same underlying proven simulation technology that leading companies have relied on for decades.

In addition, ANSYS software is accelerating on desktop, high-performance computing (HPC) and cloud environments — reducing the time involved for complex simulations from weeks to hours. Investments in areas such as reduced-order modeling and custom simulation apps allow specialists to create models that can be utilized by a broader engineering audience and produce results in a fraction of the time, without sacrificing accuracy.

Product complexity, competitive threats, the demand for better products faster — none of these challenges is going away. ANSYS will continue to develop the leading-edge capabilities you need to support digital exploration so that you can take advantage of these opportunities and tame the inherent complexities. Simulation is no longer the sole domain of specialists in large enterprises — it can be leveraged by all engineers in companies of all sizes. As your challenges increase, the capabilities and benefits of ANSYS solutions will grow with you — ensuring that your business remains a leader, no matter what the future brings. ▲

# Table of Contents

## Spotlight on Digital Exploration

4

**BEST PRACTICES****Best Practice, Best Product**

Digital exploration is the best way to investigate thousands of design options before product costs are locked in.

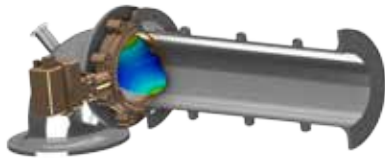

10

**DIGITAL EXPLORATION****Opening the Valve to Improved Design**

Using ANSYS AIM, Metso digitally explores the performance of a new valve design in a few hours to increase performance.

13

**ENERGY****Picking Up Steam**

KeelWit engineers managed trade-offs and reduced pressure drop across two families of heat recovery steam generator boilers.



16

**TURBOMACHINERY****Put the Right Spin on It**

Rotordynamic simulation predicts vibration problems during concept design to allow correction before building prototypes.

18

**AUTOMOTIVE****Leading the Electric Vehicle Charge**

Using ANSYS SCADE Suite, NEVS developed a battery management system that achieved 30 percent higher productivity.

22

**AUTOMOTIVE****Bright Idea for Headlights**

By reducing the time required for physical testing, engineers optimized the heat sink for an LED headlight.



26

**SEMICONDUCTORS****Taking the Leap to 7nm: Risk or Reward?**

Many of the challenges in designing a new generation of semiconductor process nodes can be addressed using upfront simulation.

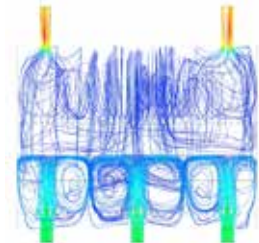

31

**CONSUMER PRODUCTS****Cooking with ANSYS SpaceClaim**

A startup creates new iterations of the design for a meat smoker in only five minutes instead of two weeks.

34

**AUTOMOTIVE****Electrifying Vehicle**

ANSYS multiphysics simulation within a consolidated platform improves electric vehicle systems and subsystems.

**ABOUT THE COVER**

Digital exploration, or upfront simulation, enables every member of the product development team to contribute to more innovative products, faster time-to-market and lower development costs.



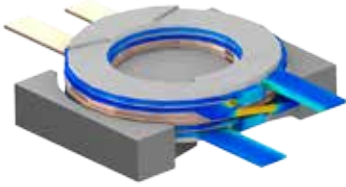

**39**

**SOLUTIONS**

### Digital Exploration with ANSYS AIM

ANSYS AIM provides the guidance organizations require to make informed design decisions.

Simulation@Work

**43**

**DIGITAL TWINS**

### Delivering a Digital Twin

Digital twins result in improved output, reduced costs, accelerated innovation and a solution that is the outcome that industry demands.

**46**

**AEROSPACE AND DEFENSE**

### Hitting the Brakes

Using ANSYS Mechanical, engineers determined the cause of Air Force jet damage and devised a simple solution to this multimillion-dollar problem.



**49**

**ENERGY**

### Vibration Power Generation

A startup pushes the boundaries of how sensors are powered by efficiently transforming ambient energy into electricity to power wireless equipment.

Departments

**53**

**CLOUD COMPUTING**

### Cloud Seeds Simulation for SMES

A software stack enables small and medium-size manufacturers to expand use of cloud computing resources for simulation.

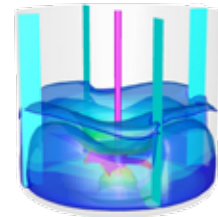

**56**

**NEWS**

### Simulation in the News

A roundup of news items featuring simulation

Join the simulation conversation  
[ansys.com/Social@ANSYS](https://www.ansys.com/Social@ANSYS)

Welcome to *ANSYS Advantage!* We hope you enjoy this issue containing articles by ANSYS customers, staff and partners. Want to be part of a future issue? The editorial team is interested in your ideas for an article. Contact us.

The Editorial Staff, *ANSYS Advantage* [ansys-advantage@ansys.com](mailto:ansys-advantage@ansys.com)

**Executive & Managing Editor**  
 Chris Reeves

**Art Directors**  
 Ron Santillo, Dan Hart

**Editorial Advisers**  
 Amy Pietzak, Tom Smithyman

**Designer**  
 Dan Hart

**Editorial Contributor**  
 ANSYS Customer Excellence  
 North America

**Cover Illustration**  
 Dan Hart, John Graham

**Senior Editor**  
 Tim Palucka

**ANSYS, Inc.**  
 Southpointe  
 2600 ANSYS Drive  
 Canonsburg, PA 15317  
 USA

**Editors**  
 Erik Ferguson     Mark Ravenstahl  
 Kara Gremillion     Walter Scott  
 Thomas Matich

Subscribe at [ansys.com/magazine](https://www.ansys.com/magazine)

**Realize Your Product Promise®**

If you've ever seen a rocket launch, flown on an airplane, driven a car, used a computer, touched a mobile device, crossed a bridge, or put on wearable technology, chances are you've used a product where ANSYS software played a critical role in its creation.

ANSYS is the global leader in engineering simulation. We help the world's most innovative companies deliver radically better products to their customers. By offering the best and broadest portfolio of engineering simulation software, we help them solve the most complex design challenges and engineer products limited only by imagination.

ACT, AIM, Anwa, Autodyn, BladeModeler, CFD, CFD Enterprise, CFD Flo, CFD Premium, CFX, Chemkin-Pro, Cloud Gateway, Customization Suite, DesignerRF, DesignerSI, DesignModeler, DesignSpace, DesignXplorer, EKM, Electronics Desktop, Elastic Licensing, Enterprise Cloud, Engineering Knowledge Manager, Eminence, Explicit STR, Fatigue, Fatjack, FENSAP-ICE, FENSAP-ICE-TURBO, Fluent, Forte, Full-Wave SPICE, HFSS, High Performance Computing, HPC, HPC Parametric Pack, Icepak, Maxwell, Mechanical, Mechanical Enterprise, Mechanical Premium, Mechanical Pro, Meshing, Multiphysics, Nexxim, Optimetrics, OptiSLang, ParaCs, Path FX, Pervasive Engineering Simulation, PEXprt, Polyflow, Professional, Professional NLS, Professional NLT, Q3D Extractor, RedHawk, RedHawk-SC, RedHawk-GTA, Rigid Body Dynamics, RMXprt, SCADE Architect, SCADE Display, SCADE LifeCycle, Suite, Test, SeaHawk, SeaScape, Slwave, Simplorer, SpaceClaim, SpaceClaim Direct Modeler, Structural, TGrid, TPA, TurboGrid, Workbench, Variance FX, Vista TF, Designer, PathFinder, PowerArtist, Realize Your Product Promise, Sentinel, Simulation-Driven Product Development, Solver on Demand, Totem

ICEM CFD is a trademark licensed by ANSYS, Inc. LS-DYNA is a registered trademark of Livermore Software Technology Corporation. nCode DesignLife is a trademark of HBM nCode. All other brand, product, service, and feature names or trademarks are the property of their respective owners.



# Best Practice, Best Product

By **Todd McDevitt**,  
Director of Product  
Marketing,  
ANSYS, Inc.

Up to 80 percent of the cost of a product's development is determined by decisions made early in the design process. Digital exploration, or upfront simulation, is the best way to investigate thousands of design options before product costs are locked in. With its widely adopted simulation platform, ANSYS enables every member of the product development team to participate in digital exploration. The result is more innovative products, faster time to market and lower development costs.

For almost half a century, engineering simulation has been helping the world's leading businesses launch their innovative product designs faster, and at a lower cost, by verifying them in a risk-free virtual world. For over 40 years, ANSYS has supplied best-in-class engineering software worldwide and currently supports the success of product development teams at more than 45,000 customer organizations.

Across all these customer engagements, one fact has emerged: the earlier that product teams can apply simulation, the better. While simulation has often been viewed as a complement to physical testing once design concepts are ready for validation, simulation can add even greater value upstream, during product ideation. By empowering the product development team to quickly explore thousands of design options via simulation at the earliest stages, companies can reduce final product cost, unleash game-changing innovation, and cut weeks or even months from their launch schedules.

Nearly 20 years ago, ANSYS pioneered upfront simulation with a product that set the bar for ease of use, automation and productivity: ANSYS DesignSpace. Building on this success, the company has worked with engineering teams across every industry to design and develop the capabilities that allow them to make better engineering decisions earlier using simulation.

Today, ANSYS offers the industry's broadest and most robust range of capabilities for digital exploration — from proven flagship solutions to leading-edge new products and capabilities designed specifically to support digital exploration.

### THE ANSYS SIMULATION PLATFORM: A FOUNDATION FOR EARLY DECISION-MAKING

By understanding how product development teams work, ANSYS has identified simulation solutions that specifically support the concept of digital exploration and has incorporated them into the ANSYS platform.

*“Companies cannot realize the full value of digital exploration without giving every member of the design team access to simulation.”*

Before designs begin to harden and before simulation is used to verify product performance, engineers ask many questions about the design, make changes and iterate until they either arrive at an optimum design or run out of time (typically it is the latter). To start, system architects will use 0-D models and system simulation to explore different product architectures and determine high-level requirements for various subsystems. They determine how much torque is required, how much heat needs to be dissipated or what loads need to be supported. To answer these questions up front requires system simulation, and integrating a heterogeneous mix of models and physics domains to simulate overall product performance. A versatile system simulation tool like ANSYS Simplorer, which supports various modeling languages and can co-simulate mechanical, electrical and embedded software systems, is paramount.

Once requirements for the various subsystems have been established, designers typically use 3-D modeling to experiment with the design. They determine the look and feel of the product and subsystems, ascertain the size and design a form that conveys what these subsystems actually do. Designing these early ideas requires a 3-D modeling tool that is easy for engineers to use to mock up their ideas at the speed of thought. ANSYS SpaceClaim, a multipurpose 3-D modeling application built on direct modeling technology and an array of intuitive tools, enables CAD experts and non-CAD experts alike to quickly create and morph designs during product ideation. ANSYS SpaceClaim also provides robust and easy-to-use tools to de-feature and simplify geometry for simulation.

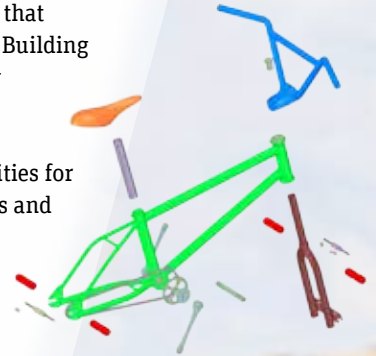

With the product architecture and basic form of the product established, designers and engineers can explore design performance using simulation, and perform what-if analysis to improve the design for functional requirements across a range of engineering disciplines, including mechanical, thermal and electrical. The parametric and persistent architecture of the ANSYS platform is very powerful at this point in the design process. Once a simulation is set up, an engineer can easily change the geometry, material, loads or a host of other design parameters, and then regenerate simulation results with a single mouse click.

In addition to manual what-if studies, designers can benefit from automated parametric optimization. A number of specialized capabilities within the ANSYS platform make it possible to systematically explore the entire design space using design of experiments (DOE) and find the best design faster.

- ANSYS DesignXplorer provides persistent, automated parametric optimization.
- ANSYS optiSLang enables product developers to not only find the best design, but the most robust design given variations in manufacturing, material or usage.

*“Businesses of all types, in every industry, can realize dramatic cost and time savings while also supporting groundbreaking product innovation — by taking advantage of upfront simulation.”*

Most companies standardize on CAD and perhaps a PLM system to document their design decisions. CAD systems are often too complex and heavy for digital exploration, but, to document the design, an engineer’s platform for digital exploration must be interoperable with these enterprise systems. To this end, the ANSYS platform provides bidirectional associativity with all the major CAD systems so that a parametric change to a model can automatically revise the geometry in its native CAD format. Design specialists can quickly explore changes and easily update their design of record in the CAD system.

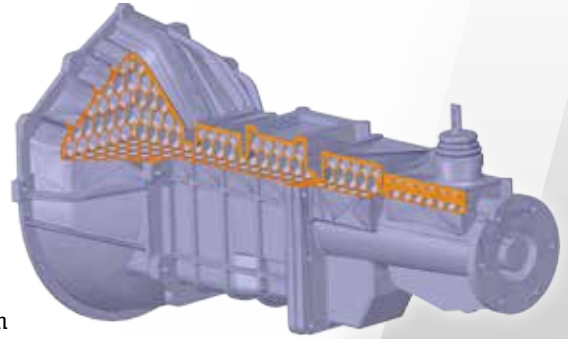

▲ ANSYS SpaceClaim enables designers to easily make changes to their design concepts and to digitally explore options long before a design is solidified.

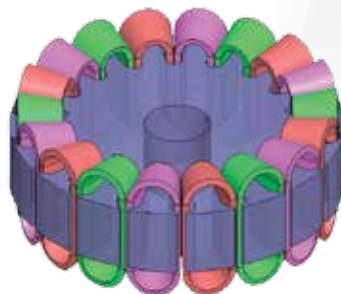
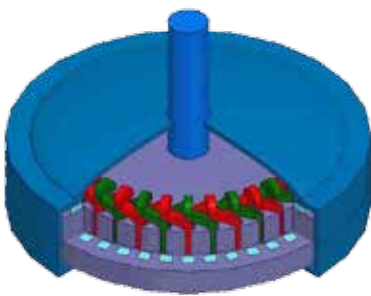

▲ ANSYS RMxprt aids designers in the early-stage development of electric machines.





Engineering teams typically have many years of experience designing the same family of products and have developed unique simulation workflows and result calculations. The ability to customize a simulation suite and create specialized applications to automate steps and integrate third-party tools or data unique to their product is vital to repeatable success in digital exploration. ANSYS ACT is an easy-to-learn yet powerful customization interface to the platform based on standard Python and XML. Engineers can create custom applications from scratch or use the

“The earlier that product teams can apply simulation, the better.”

ACT App Builder to interactively create apps. The ecosystem of ANSYS partners has also developed a rich set of simulation apps and made them available on the App Store. Customers can choose from a variety of free or cost-effective applications based on ANSYS ACT.

To bring together all these capabilities that are commonly required for digital exploration and to make it easy for non-analysts to effectively employ upfront simulation, ANSYS has developed ANSYS AIM. Learn more later in this article and throughout this issue of *ANSYS Advantage*.

### TRUSTED RESULTS FOR EARLY DESIGN DECISIONS IN EVERY DOMAIN

The benefits of digital exploration are not confined to a particular industry or engineering application. Whether designing large fabricated structures for mining or next-generation semiconductor technology, early use of simulation results in better engineering decisions, less redesign and higher-quality products. ANSYS provides industry-proven solutions for advanced structural, fluid, electromagnetic and semiconductor simulation, but these products also deliver unique capabilities and applications to designers to use at the beginning of the workflow. Built on the same underlying technology used by high-end analysis products, these solutions help engineers across different engineering disciplines make better decisions earlier in the design process.

For example, ANSYS Mechanical now includes a topology optimization capability that automatically determines where material should be added or removed to meet performance, cost or weight requirements. Using topology optimization, a designer has significantly greater freedom to create a part or assembly that is closer to the optimal design than is possible with traditional parametric optimization. The resulting design is typically more innovative but complex, making it ideally suited for additive manufacturing. By combining topology optimization with additive manufacturing strategies, companies can dramatically reduce material costs while delivering innovative, higher-quality products.

For semiconductor design, the ANSYS suite now includes ANSYS RedHawk-SC, which is based on the new SeaScape elastic computing architecture for electronic design automation. Designed to handle extremely large data sets and computations on commodity compute



Revving Up Product Development  
[ansys.com/revving](https://ansys.com/revving)

*“ANSYS offers the industry’s broadest and most robust range of capabilities for digital exploration.”*

hardware, ANSYS RedHawk-SC enables semiconductor designers to rapidly assess many electromigration and voltage drop scenarios prior to final verification stages and sign-off.

In the area of electromagnetic simulation and motor design, ANSYS RMxprt is a template-based design tool included with ANSYS Maxwell. At the conceptualization stage for electric machines, RMxprt quickly calculates overall machine performance, supports initial sizing decisions and analyzes hundreds of what-if scenarios in a matter of seconds.

In the embedded software space, software engineers can leverage the power of design exploration by relying on SCADE Test Rapid Prototyper, which works in conjunction with SCADE Display – the industry standard for human-machine interface development. Product developers can use SCADE Test Rapid Prototyper upfront in the design process to create a large number of test cases. By leveraging the power of automated image comparison and regression testing, display developers can save significant time and money by accurately predicting real-world results upfront during design.

#### **ANSYS AIM: REALIZING THE POWER OF DIGITAL EXPLORATION**

One of the most exciting developments at ANSYS has been the introduction of ANSYS AIM, a new, easy-to-use simulation solution that can be mastered by every member of the design team.

As the value of digital exploration is discovered, more and more companies are asking nonexperts to apply simulation at the early stages of product conceptualization. While some CAD vendors offer add-on simulation modules based on different technologies than those commonly used by the analyst community, ANSYS AIM delivers pervasive engineering simulation using the same proven core solver technology as that applied by analysts, but with features that make it easy to learn for designers. Companies cannot realize the full value of digital exploration without giving every member of the design team access to simulation. To learn more about ANSYS AIM, see page 39.

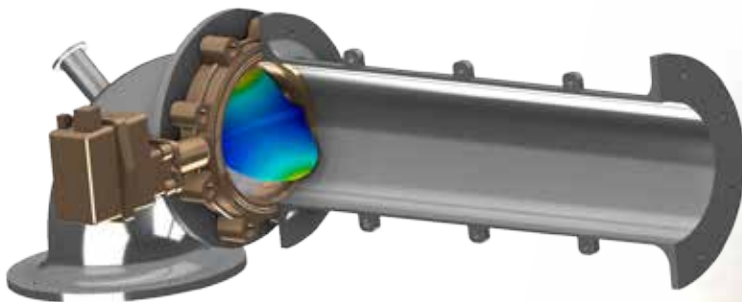

▲ Butterfly valve simulated in ANSYS AIM, an easy-to-use simulation solution for every member of the design team



**ANSYS App Store**  
[ansys.com/appstore](https://www.ansys.com/appstore)

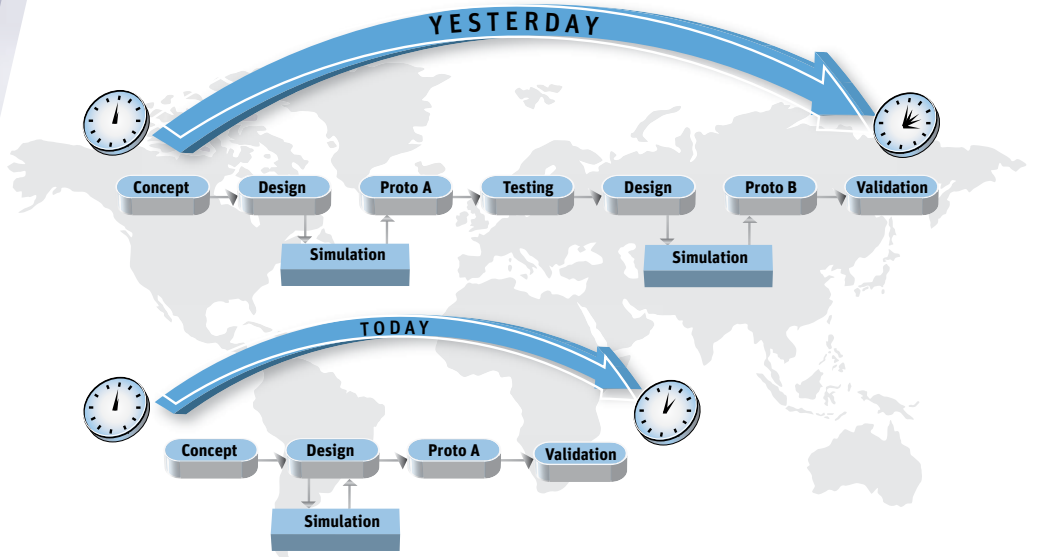

▲ Cornaglia group has increased innovation and earned a 10-times return on investment by using simulation upfront in the product design process.

### EXPLORE THE BENEFITS NOW

With a wide range of solutions and capabilities designed specifically to support digital exploration, ANSYS has eliminated almost every barrier that companies face in leveraging this best practice for product development. Businesses of all types, in every industry, can realize dramatic cost and time savings – while also supporting groundbreaking product innovation – by taking advantage of upfront simulation.

Cornaglia Group, an Italian manufacturer that develops leading-edge automotive components, including exhaust systems and fuel tanks, began implementing the concept of digital exploration in 2012. Says Massimo Marcarini, director of R&D, “Cornaglia was patenting only three innovations annually before 2012. [After implementing simulation-driven design], in 2014 alone we filed 10 patent applications. The financial benefits have been tremendous; in fact, I estimate that Cornaglia has earned a 10-times return on its investments in simulation technology.”

With the potential for these kinds of returns, it simply makes good business sense for companies of all sizes and types to implement the concept of digital exploration. ANSYS will invest in new solutions and innovative capabilities that support digital exploration so our customers can continue to experience the advantages. Our goal is to help you achieve the dramatic results, in terms of both product innovation and financial returns, that position your company for leadership today and tomorrow. ▲



**ANSYS AIM: Try It Now**  
[ansys.com/tryAIM](https://www.ansys.com/tryAIM)

# OPENING THE VALVE TO IMPROVED DESIGN

Metso Flow Control engineers require several weeks to build and test a new valve. Using ANSYS AIM software developed for design engineers, Metso engineers can digitally explore the performance of a new design in a few hours. The ability to evaluate many more designs in less time makes it possible to substantially increase valve performance and get new valves to market sooner.

By **Tommi Bergström**,  
Senior Research Engineer,  
Metso Flow Control,  
Vantaa, Finland

Valves are a vital part of almost every operation that includes fluid flow. Designing valves can be quite complex because they need to operate reliably for long periods in often adverse conditions and under exacting specifications. One of the most critical aspects of valve design is to provide a target flow rate at each point in its travel as the valve's trim (the moving parts of the valve in contact with the fluid) is opened or closed. The valve capacity coefficient ( $C_v$ ) is defined as the flow rate in gallons of 60 F water that will pass through a valve in one minute at a 1 pound per square inch (psi) pressure drop. Metso previously determined the  $C_v$  value for any proposed valve design by building a prototype and testing with water. However, building a prototype and performing the test took about four weeks for each design iteration, and in most cases several iterations were required to hit the target specifications.

Recently, Metso engineers worked with EDRMedeso, an ANSYS Elite channel partner, to adopt an ANSYS AIM solution that enables design engineers to reliably and accurately simulate the performance of a proposed design in a few hours without



▲ Metso linear globe valve

“Valve performance has been improved because engineers can evaluate many more alternatives than were possible in the past.”

Involving a CFD expert. Design engineers import a valve design from CAD and spend a few minutes setting up the simulation using one of the guided workflows in AIM. After running the simulation, AIM produces the data required to evaluate the performance of the valve. This includes quantitative data such as pressure drop and flow rate, as well as visual information such as streamlines, contour plots and vector fields to help the engineer understand the flow behavior in the valve. Valve performance has been improved because engineers can evaluate many more alternatives than were possible in the past, making new valves available to customers sooner.

### WIDE RANGE OF INDUSTRIAL VALVES

Metso is a world-leading industrial company serving the mining, aggregates, recycling, oil, gas, pulp, paper and process industries. Among the Metso Flow Control business's leading product lines are control valves, on-off valves and emergency shutdown (ESD) valves. These valves are tested in a water test loop by measuring the flow while the valve is turned through its entire travel. The new valve development process often requires multiple design iterations to meet flow performance requirements.

About a decade ago, Metso began using computational fluid dynamics (CFD) to simulate valve performance. Experienced CFD engineers performed all simulation required, from design simulation for flow and pressure drop to complex analysis to mitigate noise and cavitation. Although still much faster than build-and-test,

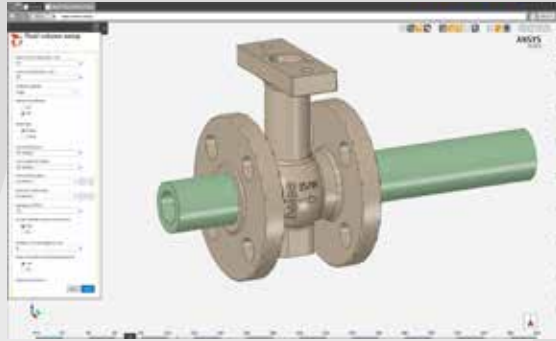

▲ Importing CAD file containing valve geometry

this slowed the design process as designers had to communicate design concepts to the simulation experts and then wait for them to simulate and evaluate the design.

### SOLUTION FOR DESIGN ENGINEERS

Metso addressed this challenge by implementing ANSYS AIM to enable design engineers to quickly

simulate linear and rotary valves without assistance from a CFD expert. AIM was selected because its interface is intended for use by design engineers. AIM uses proven ANSYS technology to perform a wide range of multiphysics tasks, including fluid, structural, electromagnetic, vibration, thermal, durability and design optimization.

To assist the designers in performing the specific parametric simulation required and automate workflow, Metso Flow Control engineers used ANSYS ACT scripting tools to develop an application that automates the CFD process, including pre-processing, solving and post-processing. Only an hour and a half of training was needed to learn how to use the scripting tools. The design engineer begins by importing either the full or symmetric valve geometry into ANSYS AIM. Named selections are used to locate the inlet, outlet, trim and symmetry. The application guides the user in

inputting the appropriate values, including pipe nominal diameter, trim diameter, feature caption, valve type, initial trim travel and maximum trim travel, etc., for a proposed design. The application determines the  $C_v$  values for a full range of trim positions. The result is a table with the  $C_v$  value at each trim position and a graph with  $C_v$  as a function

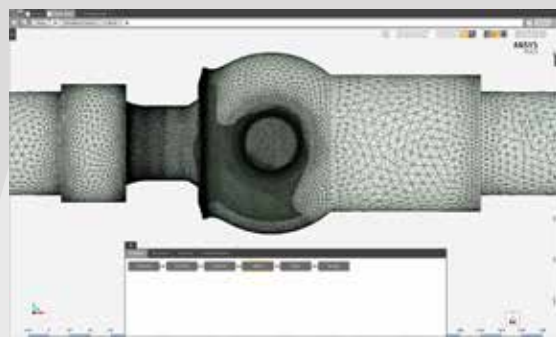

▲ AIM solution automatically sets up flow analysis including meshing.

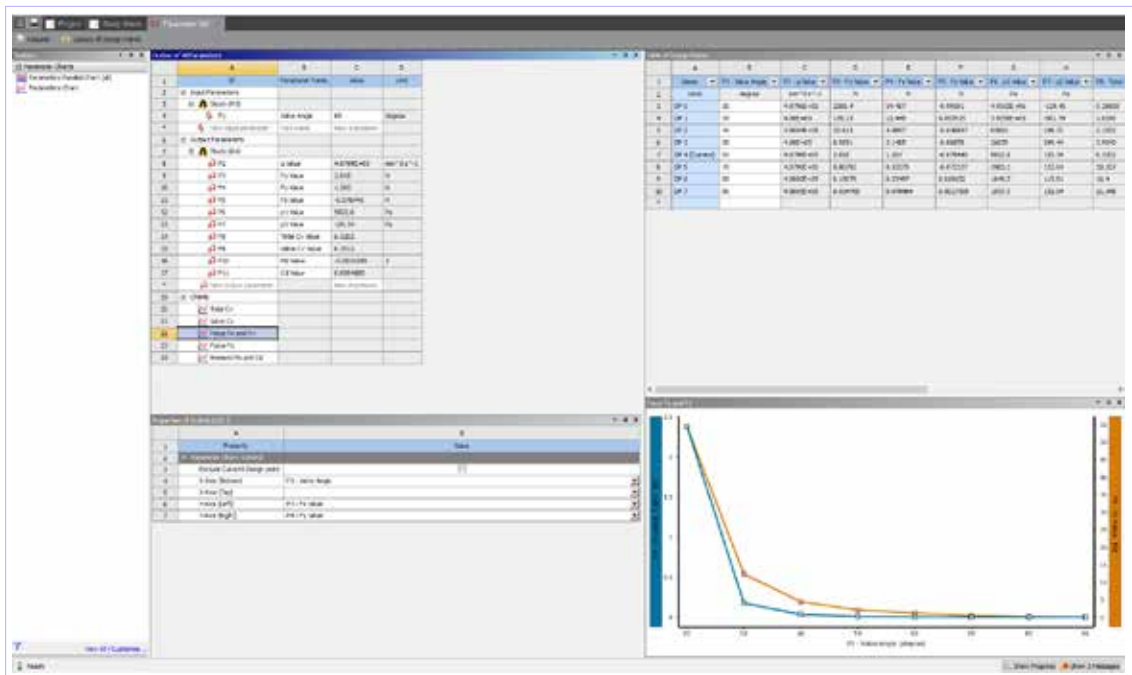

▲ The ANSYS AIM solution generates parametric results at different valve angles.

*“Metso CFD experts have been largely freed from routine valve design, and can instead focus on more challenging issues.”*

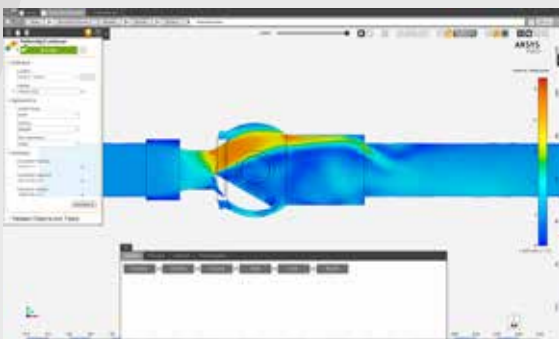

▲ Flow simulation results are presented to the user.

of trim position. The designer can then quickly determine the viability of each design.

### BUILDING A BETTER VALVE

This ANSYS AIM solution is currently available for use by every engineer at Metso Flow Control. The Metso team can now develop multiple iterations to optimize

the design of a valve in only a couple of days. The company still builds one prototype for every new valve to validate the CFD results. However, in the past, design engineers were usually limited to developing two or three design iterations because of time and cost constraints, but they can now evaluate many more design iterations to find the optimal solution in a much shorter time frame. ANSYS AIM has made it possible for the team to improve their product by, for example, reducing pressure drop or more closely matching the desired flow capacity curve. The company has also reduced time to market by decreasing the number of prototypes to one for nearly every project. Finally, the CFD experts have been largely freed from routine valve design so they can focus on more challenging issues, such as preventing cavitation and reducing noise. ▲



**ANSYS AIM: Try it Now!**  
[ansys.com/tryAIM](https://www.ansys.com/tryAIM)

# Picking Up Steam

The design of many products is complicated by conflicting design objectives. For example, minimizing pressure drop for heat recovery steam generator inlets also requires maintaining uniform flow velocity at the entry to the boiler. KeelWit engineers developed an optimization algorithm that was applied by leveraging ANSYS ACT to manage trade-offs and reduce pressure drop by up to 25 percent across two families of boilers. This substantially improved performance.

By **Isaac Prada-Nogueira**,  
Partner-Director,  
KeelWit Technology SL,  
Madrid, Spain

**H**eat recovery steam generators (HRSGs) improve the efficiency of gas turbines by recovering heat from their exhaust gases. These exhaust gases are piped into the HRSG boiler where they flow around tubes through which water is pumped. The heat from the exhaust gases transforms the water into steam, which is used to generate electricity. The inlet duct of the HRSG connects the flow from the exhaust duct of the turbine to the boiler, which requires greatly increasing the cross-sectional area of the flow. The increase in cross-sectional area tends to create flow detachment and turbulence, resulting in nonuniform velocity. This nonuniformity generates uneven flow distribution at the tubes, which causes energy losses in the boiler or reduced performance. Inlet duct designers adjust the design to smooth the flow distribution, but these changes usually increase pressure drop in the inlet duct, which creates energy losses.

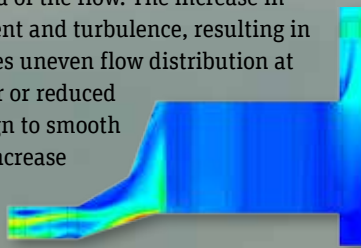

▲ Side view of velocity contours at the midplane of a typical HRSG

The challenge for the inlet duct designer is to balance these conflicting objectives to produce a sufficiently uniform velocity distribution while simultaneously minimizing pressure drop. Engineers must also keep the inlet duct as short as possible to reduce its manufacturing and assembly cost. Engineers have used computational fluid dynamics (CFD) in the past to improve inlet duct designs by manually exploring a limited design space. KeelWit has developed the multiobjective structured hybrid direct search (MOST-HDS) shape optimization algorithm, which explores a much broader design space to develop radically different inlet duct designs than those previously considered or to dramatically improve current designs. This substantially improves performance. The MOST-HDS algorithm was developed as an ANSYS ACT application. It communicates with ANSYS Fluent CFD to simulate design points, and also interfaces with ANSYS DesignXplorer to create correlation matrices to determine the impact of each design parameter on pressure drop and velocity uniformity.

With ANSYS ACT, engineering teams can create a customized simulation application to capture and use expert knowledge, specialized processes and best practices. With ACT, engineers can encapsulate APDL scripts, create custom menus and buttons to incorporate a company’s engineering knowledge, embed third-party applications, and generate

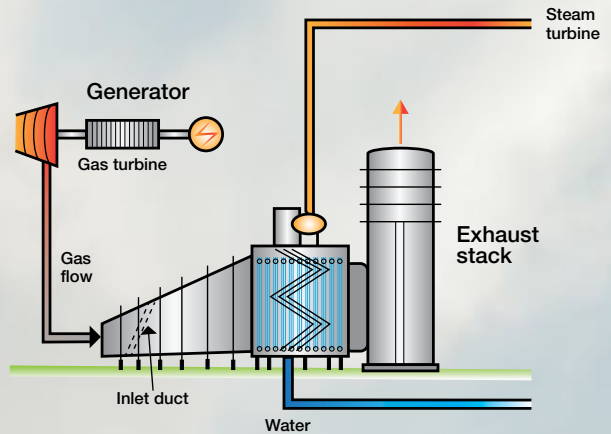

▲ Diagram of a generic heat recovery steam generator

**“KeelWit leveraged ANSYS ACT to manage trade-offs and reduce pressure drop up to 25 percent across two families of boilers to improve performance.”**

tools to manipulate simulation data. KeelWit used ACT because it makes the workflow easier, faster and more reproducible. ACT provided a robust, simple and straightforward platform for the development of optimization algorithms to interface with simulation. The MOST-HDS ACT app is proprietary to KeelWit, but KeelWit is considering making it available in the ANSYS App store.

**THE OPTIMIZATION PROCESS**

AMEC Foster Wheeler is a worldwide provider to the infrastructure, manufacturing and process industries with 40,000 employees. The company contracted with KeelWit to improve the design of the inlet duct for a number of new families of HRSGs. KeelWit engineers imported the inlet duct geometries of the previous generation of boilers into ANSYS DesignModeler and parameterized two angles on the top wall, two angles on the lateral wall, two angles on the bottom wall, and the total length of the inlet. Designs with curved walls or intermediate angles were not considered because they would be too expensive to manufacture and assemble. As a starting point, engineers used ANSYS DesignXplorer to create a design of experiments with 120 design points and perform CFD on each to provide an initial approximation of the design space.

As a starting point, engineers used ANSYS DesignXplorer to create a design of experiments with 120 design points and perform CFD on each to provide an initial approximation of the design space.

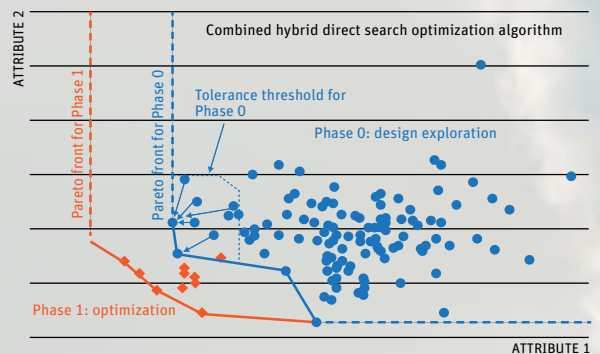

▲ Pareto front generated by initial design exploration (blue) and first phase of optimization (orange)



The KeelWit engineers then created the MOST-HDS optimization as an ACT application. The MOST-HDS algorithm reads the results from DesignXplorer and generates a Pareto front diagram that arranges the pressure drop and velocity uniformity of each design point on a two-dimensional graph; the axes of the graph are configured so that an ideal design with zero pressure drop and perfect velocity uniformity is at the origin. This Pareto method determines the outer shell of performance values facing the origin. The value of the Pareto front is that those elements not on the front are never the best choice; there is always an element on the front that is at least as good for every objective. The velocity uniformity for each simulation iteration was calculated as the difference between the average velocity weighted by area and

**“The optimized design points reduced manufacturing and assembly costs by up to 95,000 euros.”**

the average velocity weighted by mass flow as the flow leaves the inlet duct and enters the boiler. KeelWit engineers found this method to be one of the most robust approaches to address minor mesh irregularities that can yield misleading results if the minimum and maximum velocity values are used to calculate the velocity nonuniformity.

### GENERATING NEW DESIGN POINTS

Next, the optimization algorithm selects pairs of design points to be parents of the next generation of design points. The design parameters in each parent are crossed with the design parameters of the other parent to produce “children,” combining elements of genetic, gradient and swarm search into a hybrid algorithm. The child designs are then simulated automatically through ACT. Some of these designs provide improvements over their parents, advancing the Pareto front toward the origin or optimal design. The procedure is repeated over and over until the Pareto front stops advancing. In this application, the MOST-HDS algorithm produced a number of unconventional design points that were non-intuitive yet provided very high performance.

### SUBSTANTIAL PERFORMANCE IMPROVEMENTS

The result of the optimization process was a Pareto front for each of the HRSG families. A Pareto front is superior to a single optimized design point because it allows engineers to trade off pressure drop against velocity nonuniformity based on the requirements for each of the HRSGs in the family. Individual designs in these Pareto fronts improve pressure drop by up to 40 percent and velocity uniformity by up to 15 percent. However, because these improvement values were achieved at different points on the Pareto front, making each of these improvements requires sacrificing other performance values. Optimum trade-off design points with pressure drop reductions of 20 percent to 25 percent and velocity uniformity equal to the existing design were achieved for each family of HRSGs. The total length of the inlet duct and its lateral surface were also calculated for each design point as a proxy for manufacturing and assembly cost. Optimum trade-off design points with lateral surface reductions of up to 38 percent and length reductions of up to 16 percent were achieved for each design family without any sacrifice in performance. The optimized design points reduced manufacturing and assembly costs by up to 95,000 euros.

Ever since HRSGs began to be used in power plants, the shape of their inlet ducts has been varied over a relatively narrow design space. KeelWit engineers used an innovative optimization algorithm in an ANSYS ACT application to make major improvements to two families of AMEC Foster Wheeler HRSGs. The result was a substantial improvement in pressure drop along with a manufacturing cost reduction. ▲

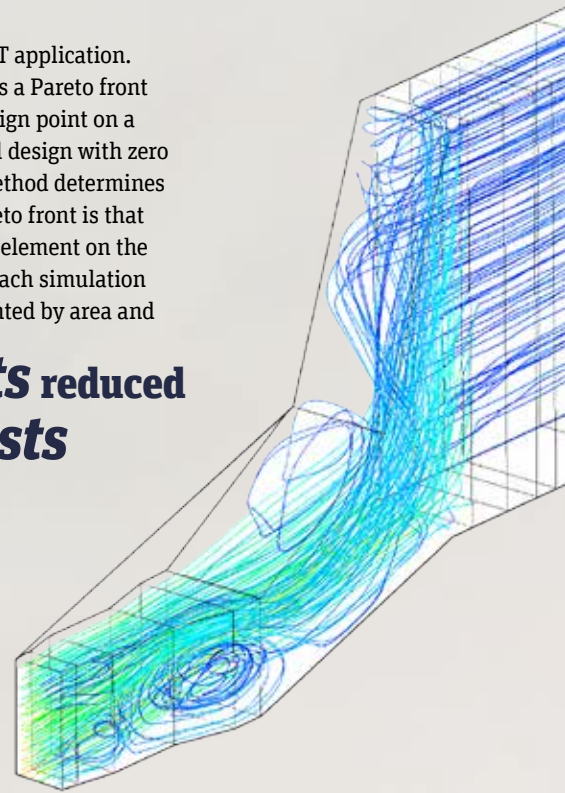

▲ Detailed isometric view of velocity magnitude streamlines in inlet duct of HRSG

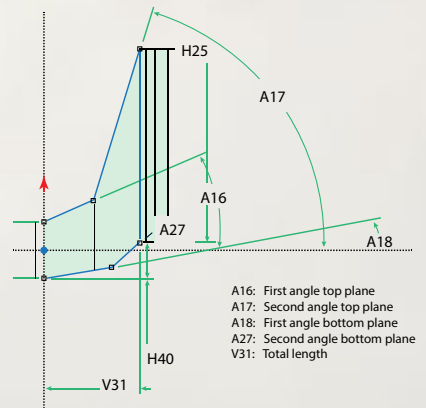

▲ Only some of the variables used to parameterize inlet duct design points



ANSYS App Store  
[ansys.com/appstore](https://www.ansys.com/appstore)

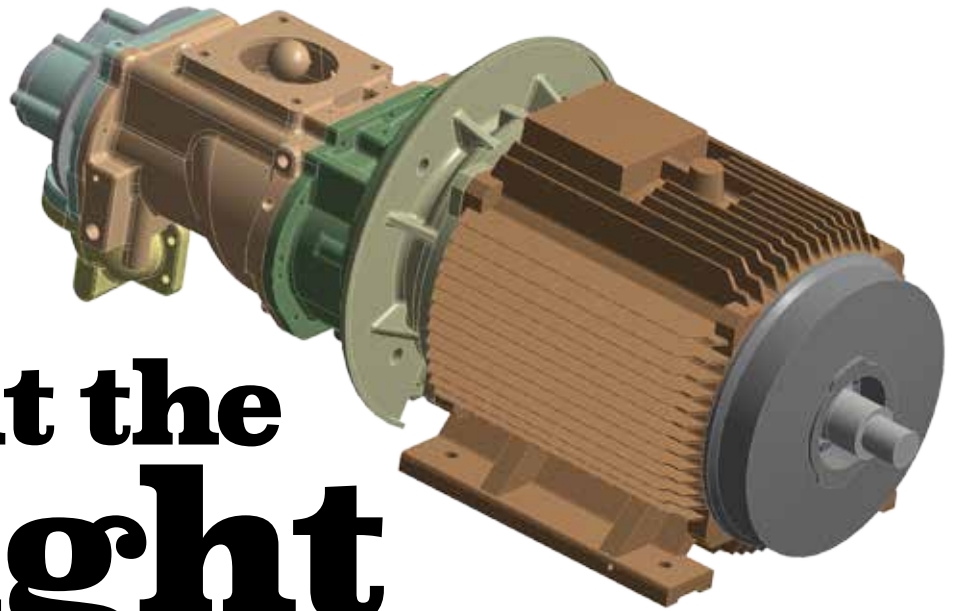

# Put the Right Spin On It

Vibration can degrade the reliability of rotary air compressors. Ingersoll Rand engineers implemented rotordynamic simulation to predict vibration problems in the concept design phase so that they can be corrected before building prototypes. Ingersoll Rand has reduced prototyping costs and generated additional revenues by bringing products to market earlier.

**C**ontrol of potential vibration effects plays a critical role in the design of rotary air compressors. The traditional process of building and testing prototypes, and then performing redesign to reduce vibration, consumes manpower, budget and time. Every month of delay in getting a new product to market represents a significant revenue loss. With internal engineering resources stretched to the limit, Ingersoll Rand engaged ANSYS Customer Excellence (ACE) consultants to validate 3-D rotordynamic analysis of rotating and stationary components on

By **Yi Liu**, Engineering Manager, Ingersoll Rand, Charlotte, USA

a compressor design. This vibration problem had previously been solved only by painstaking trial and error. Without knowing details of the problems with the previous design, the consulting team used simulation to help predict the housing vibration caused by connection between the rotors and housing assembly. The team then trained Ingersoll Rand engineers, who simulated six additional design iterations and developed a solution to the problem in much less time than had been required to solve the problem previously. Ingersoll Rand has since saved hundreds of thousands of dollars in product development costs by using rotordynamic simulation upfront in the development process to identify and solve vibration problems on digital prototypes.



▲ Ingersoll Rand rotary air compressor

## Product Development Challenges

Ingersoll Rand rotary air compressors are used in mission-critical applications in many industries. To ensure product reliability, the company sets strict limits on vibration of rotating and stationary assemblies. The most common source of a vibration problem is a component that resonates at a potential operating frequency of the compressor. Because a typical rotary compressor has hundreds of components, even after a vibration problem has been identified with physical testing, it is often very difficult to determine which component is responsible for the issue. One approach is to hammer the component and measure its resonant frequencies. But connecting components often affects resonant frequencies. In addition, many components connect with others in ways that make it impossible to test them in an operational configuration. For example, components may connect deep inside a housing where they cannot be reached with a hammer-impact test, which is a physical test to determine the natural frequencies, modal damping or mode shapes of a structure. The rotational aspects often bring in other considerations, like speed-dependent dynamic bearing coefficients and gyroscopic effects of rotating masses.

Ingersoll Rand engineers tried using a one-dimensional rotordynamic model that relies on mass spring damper 1-D elements, but found that it could predict vibration of rotating but not stationary components. The engineers believed that 3-D simulation could solve the vibration issue, but to try to apply this new approach and gain the required insight would affect the design schedule. Ingersoll Rand engaged ACE consultants to validate the ability of 3-D rotordynamic analysis to locate the vibration problem and determine a solution. ANSYS rotordynamic software can account for all of the physics involved in rotating assemblies in a single analysis, so it can solve problems with a minimum of assumptions and provide answers that may not have been considered before. ANSYS software leverages robust 3-D analysis methods to couple the rotating elements to a full 3-D representation of the support structure, offering a more detailed result of the overall structural response.

## ANSYS Team Applies Rotordynamic Analysis

The ACE team integrated characteristic rotordynamic features such as gyroscopic effects and bearing support flexibility into an ANSYS Mechanical finite-element model of the rotating and stationary components of a design with a known vibration problem. The team modeled the rotating parts, stationary parts and bearings linking the rotating parts to the stationary parts. For the rotating parts, ANSYS staff selected elements that support gyroscopic effects while modeling the stationary parts with normal 3-D solid, shell and beam elements.

They defined material properties just as they would for any other analysis and designated the rotational velocity. Engineers accounted for the gyroscopic effect in rotating parts and the rotating damping effects. The consultants performed modal analysis to review the stability of the design and obtained critical speeds from Campbell diagrams. ACE team engineers leveraged harmonic analysis to calculate the response of the compressor to synchronous or asynchronous excitations and proposed using transient analysis to determine what happened when the compressor started and stopped.

## Transferring Simulation Knowledge to Ingersoll Rand

The results predicted that the design would have a vibration problem that closely matched the magnitude and frequency of the vibration that had earlier been detected during physical testing. The rotordynamic simulation provided much more information than physical testing, including identifying the critical speeds at which the compressor would vibrate and the resonant frequencies of the components.

With the method validated, ACE consultants trained Ingersoll Rand engineers who explored the design space to minimize vibration of the rotor and

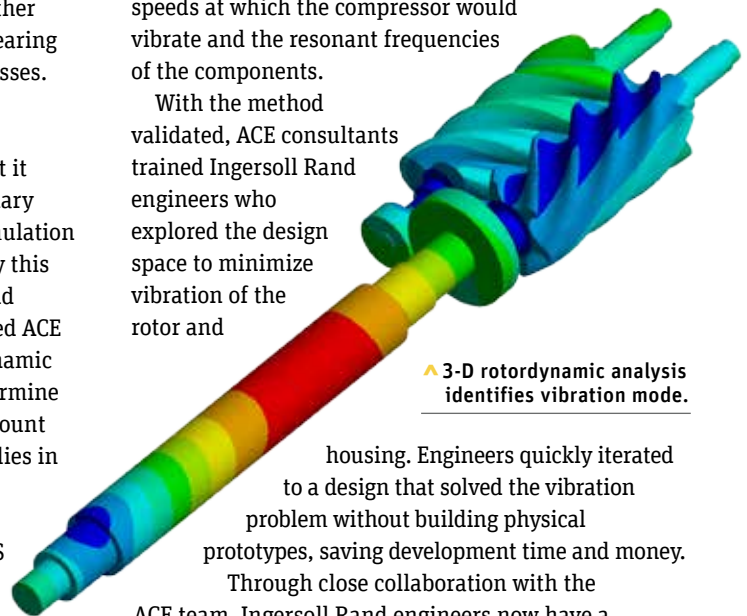

▲ 3-D rotordynamic analysis identifies vibration mode.

housing. Engineers quickly iterated to a design that solved the vibration problem without building physical prototypes, saving development time and money.

Through close collaboration with the ACE team, Ingersoll Rand engineers now have a streamlined process to expertly and independently leverage simulation to design six additional variants of the compressor. Ingersoll Rand engineers now use rotordynamic simulation to develop new compressor designs on a regular basis with a 50 percent to 70 percent reduction in the need to build physical prototypes for testing. The use of ANSYS simulation-based design has greatly reduced scheduling delays in delivering new products, resulting in a substantial increase in revenues. ▲



ANSYS Consulting  
[ansys.com/consulting](https://www.ansys.com/consulting)

# Leading the Electric Vehicle Charge

The battery management system plays a critical role in today's electric vehicles: It monitors the state of the battery, manages its operation to optimize vehicle performance and battery life, and ensures the safety of occupants. Researchers at National Electric Vehicles Sweden (NEVS) who are developing the BMS for their next-generation electric vehicle are achieving 30 percent higher productivity by using ANSYS SCADE Suite instead of the industry's traditional model-based design toolset.

By **Christian Fleischer**,  
Manager Software Architecture –  
Advanced Battery Technology,  
National Electric Vehicles Sweden,  
Trollhättan, Sweden

**“The SCADE model allows them to *detect errors* in their specification *early* in the *design process* *instead* of during integration testing.”**

**T**he battery is the most expensive component in an electric vehicle. It helps to determine the range of the vehicle, which is a crucial performance specification parameter. The battery management system (BMS) plays a key role in optimizing the performance of the battery by monitoring its condition and controlling its operation. As the brains behind delivering the power required to operate the vehicle, it conserves the charge to prolong the life of the battery, and detects and responds to unsafe operating conditions. A team of 10 researchers at NEVS, the successor to the famed Saab automotive brand, are developing a cutting-edge BMS for the company's next-generation electric vehicle.

NEVS researchers did not use the automotive industry's most widely used model-based development toolset because it includes a code generator that is not compliant with the safety standard governing the embedded software development process. This toolset produces code that requires extensive manual verification, validation and back-to-back testing. Instead, NEVS researchers selected the ANSYS SCADE end-to-end model-based development solution, which includes an ISO 26262-qualified code generator that eliminates the need for costly code reviews and low-level testing activities to verify that the code is functionally equivalent to the model. The team expects to achieve a 30 percent productivity gain compared to the usual toolset. Upfront simulation is vital in the electric vehicle industry where competition is fierce and time to market is paramount.

### UNDERSTANDING BATTERY STATE

The battery of an electric vehicle is a highly nonlinear system with a continually changing state. Understanding changes in each cell of the battery is critical to optimizing the performance of an electric vehicle. The battery contains a wide range of sensors to monitor its operation, and the BMS interfaces with these sensors to measure voltage, current, temperature and other parameters. But it is not possible to incorporate enough sensors to provide a complete picture of the battery's condition, so the BMS uses complicated algorithms to estimate the battery's state of charge (SOC)



▲ The BMS master controller embedded hardware (red) sits on top of the BMS slave controller (green), which in turn sits on top of the battery demonstrator. The slave controller measures cell voltages and temperature, and executes the cell balancing strategy. The high-voltage battery disconnect (black box in rear) is responsible for connecting and disconnecting the battery from the load.



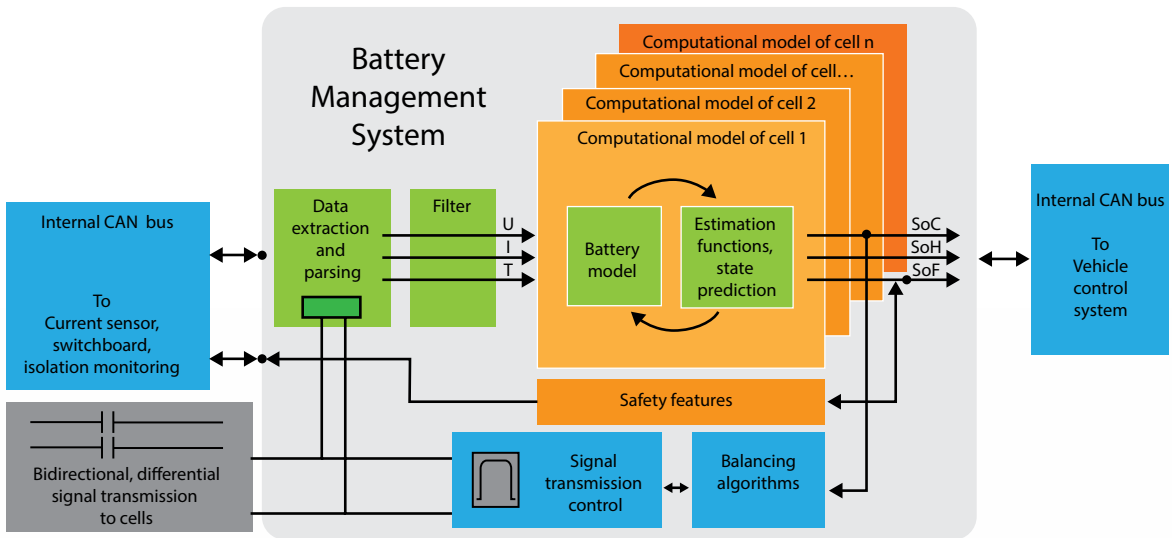

▲ Overview of battery management system functionality. Information courtesy Fraunhofer IISB.

[the equivalent of a fuel gauge for the battery pack], its state of health (SOH) [the condition of the battery compared to its ideal conditions], its state of life (SOL) [the remaining useful life of the battery] and other important parameters.

Based on its estimation of the battery condition, the BMS controls the battery to protect against over-charge, over-discharge, over-current, short circuits, overheating, ground-faults and other potential problems to maintain the battery in a state in which it can fulfill its functional design requirements for as long as possible. The BMS also informs the application controller how to make best use of the battery at any moment to power the vehicle.

**SELECTION OF MODEL-BASED DEVELOPMENT TOOLSET**

When preparing for the BMS development process, NEVS researchers evaluated the leading model-based development environments. Model-based development has greatly improved the quality and time-to-market of safety-critical automotive systems such as BMSs by enabling a graphical model to replace software architectural and unit design during the development process. Engineers can simulate the behavior of the model and immediately view the results without the need for physical hardware. This makes it possible to gain critical insights early in the design process and rapidly improve the model’s performance. Later, the model is used to automatically generate the embedded code, eliminating the need for manual coding and enabling the engineers to test their model instead of the code. This eliminates all code-based verification of the application.

**“The team expects to achieve a 30 percent productivity gain compared to the usual toolset.”**

NEVS engineers recognized that they would need to automatically generate the embedded code many times during the development process as they improved the BMS. Using the traditional development toolset, each of these iterations would require back-to-back testing and functional testing phases to verify that the generated code implements the requirements correctly and matches the behavior of the model used in the design process. Some parts of this testing process can be automated, but others, such as demonstrating traceability of software requirements, must be done manually.



**Developing ISO 26262-Compliant Automotive Safety-Related Applications**  
[ansys.com/compliant](http://ansys.com/compliant)

# “NEVS researchers are *substantially reducing the time* required to develop the *battery management system*.”

## BMS DEVELOPMENT PROCESS

NEVS eliminated the need for this manual effort by using the ANSYS SCADE Suite complete end-to-end model-based development toolset to develop its BMS. The researchers use the SCADE Architect tool to describe the system and software architecture using SysML block diagrams. They write algorithms on a whiteboard to address the functional requirements of the BMS. This is followed by modeling the algorithms and other software components associated with the architecture, using complex state machines and data flows to model the logic and control laws. They then simulate the model to detect functional faults early in the design process. By creating, running and validating functional test cases in the SCADE Test environment for the SCADE model early in the design process the researchers can detect errors in their specification sooner, instead of during integration testing.

When researchers feel the model is ready, they use the SCADE Suite KCG code generator to generate C source code for the target environment. This code generator has been qualified for developing ISO 26262-compliant applications up to ASIL D, the highest safety requirement for automotive applications. They run the generated code on the target

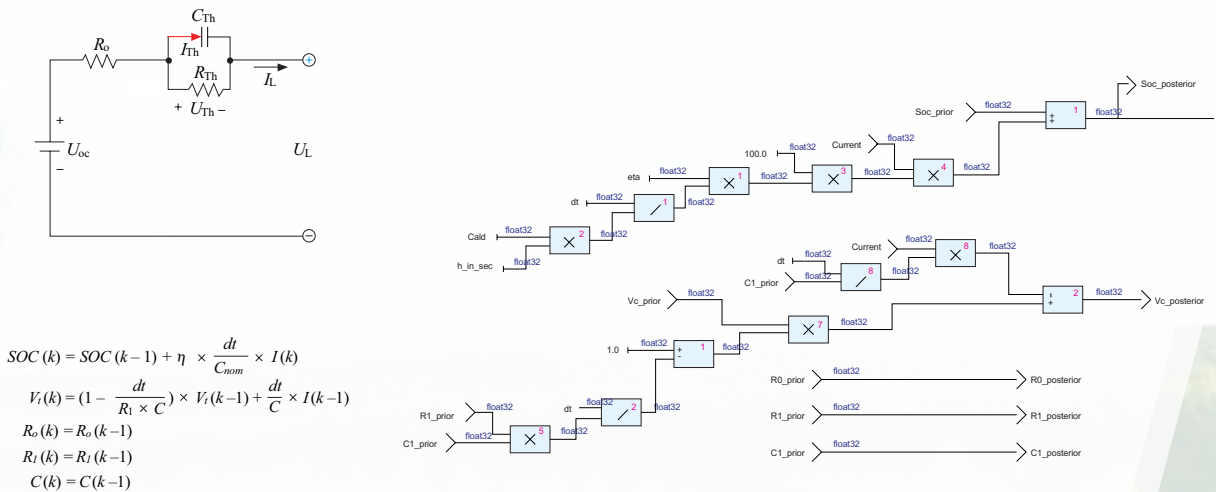

$$SOC(k) = SOC(k-1) + \eta \times \frac{dt}{C_{nom}} \times I(k)$$

$$V_i(k) = \left(1 - \frac{dt}{R_i \times C}\right) \times V_i(k-1) + \frac{dt}{C} \times I(k-1)$$

$$R_o(k) = R_o(k-1)$$

$$R_l(k) = R_l(k-1)$$

$$C(k) = C(k-1)$$

▲ View of battery management system model developed in ANSYS SCADE Suite

hardware connected to a demonstrator battery to evaluate its performance. NEVS researchers have developed simulated driving cycles that they use on the demonstrator to evaluate the ability of the embedded software to accurately predict the state of the battery. The researchers tune the algorithms to better capture the physical and chemical behavior of the battery cells. For example, they compare the algorithm’s voltage predictions with physical measurements on the battery cells.

By implementing the ANSYS SCADE tool chain, NEVS has achieved substantial advantages compared to automobile original equipment manufacturers using the conventional industry tool chain. Maximizing the performance of NEVS’ next-generation vehicle will require many model-generation code-testing iterations. On each iteration, the SCADE KCG code generator eliminates the time normally required to verify that the generated code matches the model, to perform code reviews and to prepare documentation. As a result, NEVS researchers are substantially reducing the time required to develop the BMS. ▲

# Bright Idea for Headlights

Momentive Performance Materials successfully reduced the time required for physical testing by using simulation to optimize the heat sink design for an LED automotive headlight. This simulation yielded a design that demonstrated a two-fold increase in the brightness of the headlight while operating at the same temperature.

By **Manjunath Subbanna**, Senior Technology Engineer; **Eelco Galestien**, Project Engineer; **Creighton Tomek**, Ceramics Technologist; and **Wei Fan**, Ceramics NPI Manager; Momentive Performance Materials, Strongsville, USA

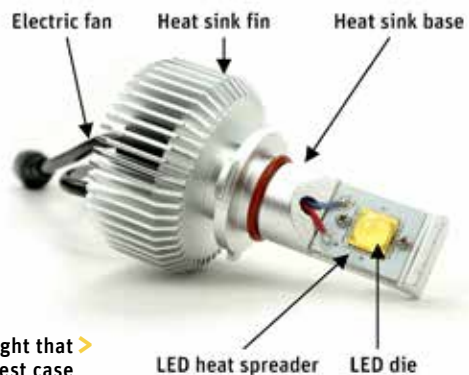

Aftermarket LED headlight that was used as a test case >



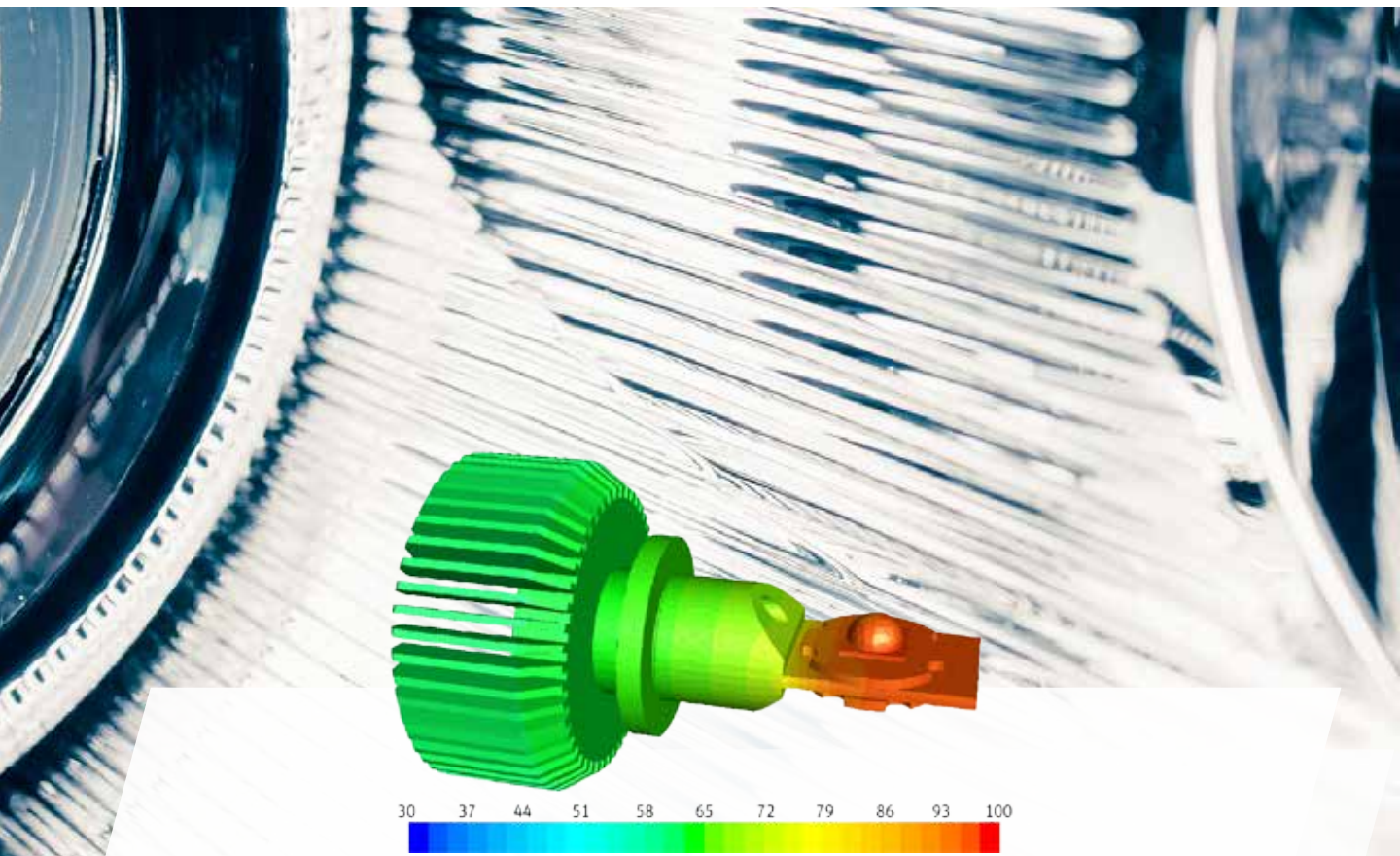

▲ Simulation results for the original LED assembly design revealed bottlenecks in heat flow.

**L**ight emitting diodes (LEDs) are increasingly being used as automotive headlights with an estimated 20 percent of cars expected to be equipped with them by 2020. Their low energy consumption improves energy efficiency while their small size provides greater freedom to produce stylish and innovative designs. The biggest obstacle to increased use of LEDs is thermal management. Typically, 70 percent of the energy is converted to heat. LEDs are also more sensitive to heat than alternative lighting technologies because, like other semiconductors, their junctions must be kept cool to operate properly. Most LED headlights use aluminum or copper heat sinks, and forced air or liquid cooling to dissipate heat.

Momentive Performance Materials (Momentive) has developed thermal pyrolytic graphite (TPG), a new material that provides four times the thermal conductivity of copper at one-fourth the weight. The high thermal conductivity of TPG comes from highly oriented graphite crystals in a layered structure. As a way to market this new material for automotive applications, Momentive set out to develop new heat sink designs that could improve the performance of current LED headlights. Building and testing a single prototype would take weeks of effort and many prototypes to optimize the design, but by leveraging the use of ANSYS Fluent computational fluid dynamics (CFD) software, Momentive engineers were able to accurately predict the performance of alternative thermal management designs in only 15 minutes. In a generic application, the engineers demonstrated through simulation that TPG could double the brightness of an LED with the same basic thermal management design. Alternatively, by eliminating a fan used for forced-air cooling, engineers could reduce thermal management costs and energy consumption, as well as improve the headlight reliability, all while maintaining the same brightness. The finalized designs were then prototyped, and the measured performance of the LED assemblies matched the simulation performance predictions.

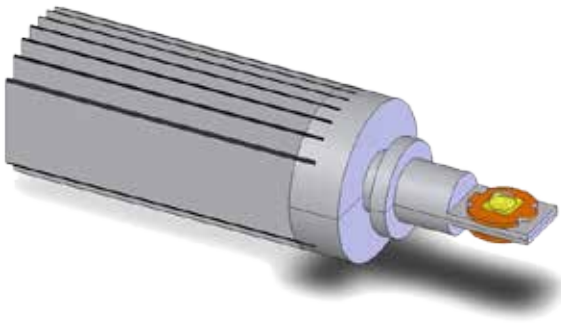

▲ LED assembly design modified to use TPG heat sink fins

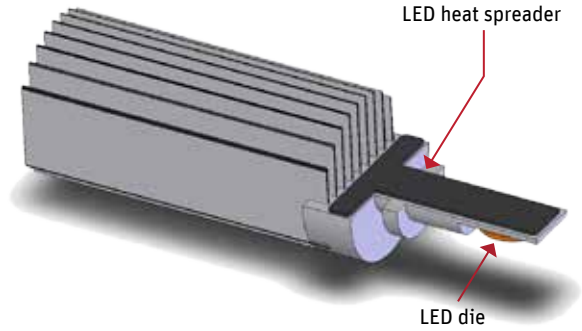

▲ Improved LED assembly design with TPG heat sink core and fins

### SIMULATING THE ORIGINAL DESIGN

The diode junction temperature of an after-market LED headlight must be kept below 120 C. The original design cools the LED with a heat spreader, a heat sink base and fins, and an electric fan. Momentive engineers used ANSYS CFD to model all the components of the assembly and added the thermal conductivity of each component to the model. The heat input was estimated at 70 percent of the 30-watt total input power to the two LEDs and specified as a volumetric heat source in the LED chip. The model was simulated with a forced air flow of 3 cubic feet per minute. The

a soft material due to the weak van der Waals force between the graphene layers, it must typically be contained in some structural member. In this case, a thin tin coating was identified to protect the TPG material from moisture and abrasion, and to make it possible to reflow and solder TPG material directly to the aluminum base. The high thermal conductivity of the TPG material can spread the heat more uniformly across the entire fin structure, utilizing the fin surface more efficiently. The simulation results yielded a thermal resistance of 4.7 C/W, which was 20 percent less than the resistance of the baseline design.

*“Changing the heat sink fins and base to a TPG-based material can allow a twofold increase of the input power to the LED, while doubling the brightness of the LED.”*

simulation predicted an overall thermal resistance of 5.9 C/W. The device was also instrumented with thermocouples at the LED die, LED heat spreader, heat sink base, heat sink fins and light housing. The temperatures at each location as a function of input power were collected after the temperature reached equilibrium. Temperature profile predictions from simulation matched the experimental data, confirming the accuracy of the simulation.

### IMPROVED FIN DESIGN

Based on the study of the baseline model, the heat sink fins and heat sink base were identified as the bottlenecks for heat flow. The next step was to modify the heat sink fins and base designs to improve thermal conduction and to validate their performances through CFD modeling. Momentive engineers changed the heat sink fin material in the model to a laminate consisting of a TPG core with a tin coating. As TPG is

### IMPROVED CORE DESIGN

Next, Momentive engineers looked at a design to facilitate heat flow through the narrow neck area of the heat sink base, beginning with replacement of this area with a T-shaped TPG tile brazed into an aluminum enclosure with a T-shaped cavity. High-temperature brazed joints between the metalized TPG material and aluminum enclosure components were specified to provide excellent thermal interfaces and high bonding strength, and to endure the downstream soldering temperatures that develop when the LED dies and TPG fins are attached. The simulation showed that the TPG heat sink base would reduce the temperature gradient along the narrow neck at the heat sink base and the heat sink fins, and increase the effective area dissipating heat to the air. Simulation results for the LED with a TPG heat sink core yielded an additional 29 percent reduction in thermal resistance with a nominal thermal resistance of 3.0 C/W. This is a total

“Momentive engineers are making extensive use of simulation to demonstrate the benefits of TPG-based thermal management solutions and to reduce the number of product development cycles.”

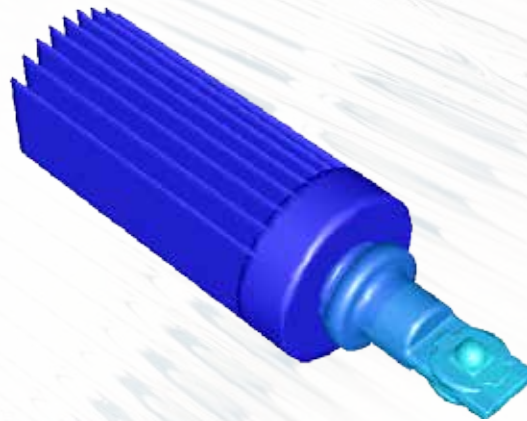

reduction of 49 percent from the base design.

The simulation concluded that in this specific application, changing the heat sink fins and base to a TPG-based material would allow a twofold increase of the input power to the LED, while doubling the brightness of the LED without increasing the LED junction temperature, as compared to the baseline design. The simulation results were later confirmed by measurement of LED headlight prototypes that were built on the basis of the above designs. Further exploration showed that the headlight could be run at the existing 30-watt power level without the need for an electric fan, effectively reducing the cost, weight

▲ Simulation of LED headlight with TPG heat sink core and fins helped achieved 49 percent thermal resistance reduction.

and energy consumption of the headlight, and increasing its reliability by eliminating a potential failure point. Going forward, Momentive engineers will be making extensive use of simulation to demonstrate the benefits of TPG-based thermal management solutions to customers

in the automotive, aerospace, telecommunication and defense industries. Using simulation early in the design process is crucial for the energy efficiency and performance of all high-power electronics. Simulation can also demonstrate the benefits of improved designs to potential customers.▲

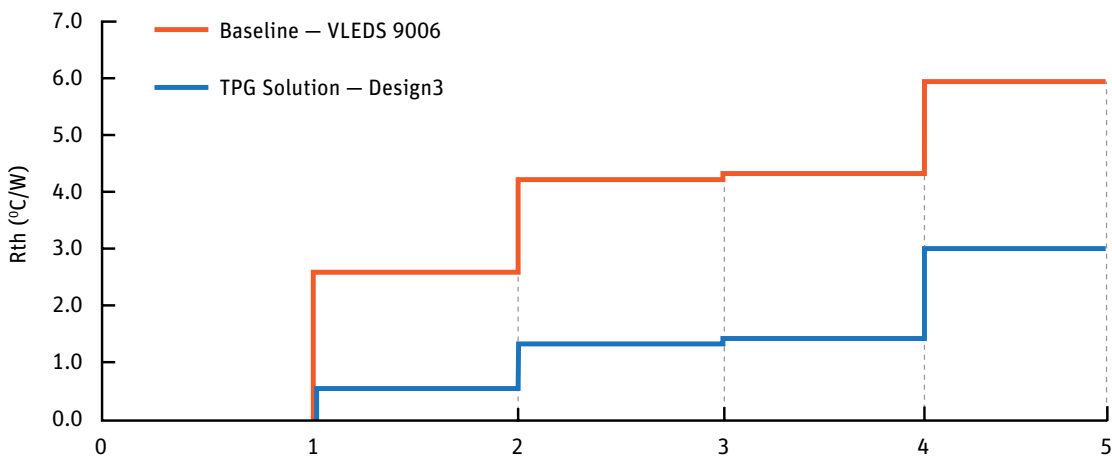

▲ Simulation results for LED with TPG heat sink core and fins show 49 percent reduction in thermal resistance and 104 percent additional power at equal temperatures (which matched physical measurement).



Thermal Optimization for Energy Efficiency  
[ansys.com/bright](https://www.ansys.com/bright)

# Taking the Leap to 7nm: Risk or Reward?

By **Arvind Vel**,  
Director, Application  
Engineering,  
ANSYS

Benefiting from the advances in semiconductor process node improvements is no easy feat. A host of design challenges and risks accompany every new generation of process nodes. The 7nm node is by far the most advanced available today from all leading foundries. This process node fundamentally challenges the basic assumptions of margin-based design. At the same time, it also pushes the boundaries of power and performance benefits that are available to designers. With the 7nm node being the industry driver for the near future, designers are fundamentally rethinking their design implementation strategies using upfront simulations.

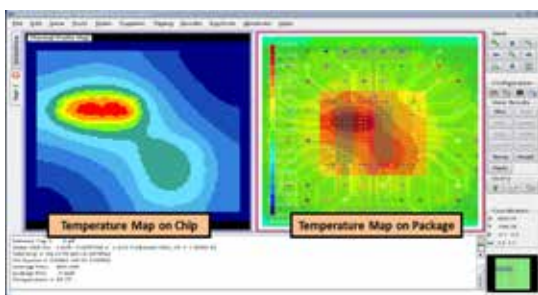

▲ Accurate chip–package thermal analysis using ANSYS RedHawk-CTA

Power and performance have always been competing vectors in advanced system-on-chip (SoC) semiconductor design. The benefit of using a 7nm process node is the ability to operate at a much lower supply voltage (sub 500mV) without compromising performance, primarily due to the increased drive current per unit transistor. In addition, the leakage characteristics for these nodes are much lower than planar CMOS transistors. These defining characteristics of the 7nm process node make it a great target for advanced SoC designs for integrated device manufacturers (IDMs) as well as fabless semiconductor companies.

*“With the 7nm node being the industry driver for the near future, designers are fundamentally rethinking their design implementation strategies using upfront simulations.”*

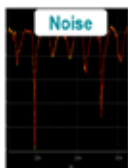

- Lower noise margins**
- Lower voltage drop immunity
  - Validate all operating modes

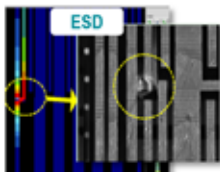

- Lower gate breakdown voltage**
- Narrow ESD design window
  - Mandates simulation-based checks

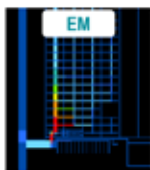

- Higher I, lower EM thresholds**
- Complex EM rules
  - Power and signal EM analysis needed
  - Multimode EM sign-off needed

▲ Key reliability issues at 7nm

Historically, the move to a smaller process node is accompanied by a decrease in cost per transistor in a unit area. In the 7nm process node, the geometry scaling trend has plateaued, and the complexity of lithography masks has increased, making the cost per unit transistor significantly higher than that of previous generations.

Fabless semiconductor companies need higher margin products or significantly larger volumes to offset the cost involved in 7nm design. Additionally, the performance of the chip must add significant value to the product itself. Under these circumstances, the cost of failure for a 7nm chip is extremely high, and fabless companies are always weighing the risk-versus-reward balance in moving to this new process node.

**CHALLENGES AND RISKS**

Power noise closure remains one of the biggest challenges for 7nm designs. To leverage the quadratic scaling of supply voltage on dynamic power, design teams push the boundaries to operate as low as 470 mV. At the same time, the threshold voltage (VT) has remained constant over the past few process nodes. This combination of decreased supply voltage and nearly unchanged threshold voltage has led to a rapid decrease in

operating noise margin for the 7nm node. Traditional margin-based approaches for voltage drop sign-off quickly break down under these circumstances.

Supply noise mitigation requires a ground-up design philosophy at 7nm. Selecting the right logic library, power grid architecture with metal stack, clocking scheme and the appropriate IC package, have a profound effect on the noise immunity of the design. The challenges in having proper simulation coverage to capture noise-induced failures are more insidious in nature. Starting with a robust power grid to satisfy all margin requirements can be a tempting mistake. This can have consequences downstream on timing and routing closure, therefore impacting die size. Using a simulation-backed power grid architecture that covers all operating modes for local and global switching

*“With the 7nm node being the industry driver for the near future, designers are fundamentally rethinking their design implementation strategies using upfront simulations.”*

failures is mandatory. To boost sign-off confidence, hundreds of logically consistent scenarios need to be profiled, and the ones with the best coverage metrics should be simulated. Coverage metrics can involve switching behavior, peak currents, effective resistance, timing slack or a slew of other parameters. This is no easy task given the complexity of today’s SoC designs. Platforms such as ANSYS RedHawk-SC can profile hundreds of scenarios using a vector-based or vector-less approach to capture design weaknesses.

Reliability simulation for electromigration (EM) and thermal analysis is another challenging area for 7nm design sign-off. The FinFET device architecture fundamentally limits the thermal conduction pathway from the fin structure to the silicon substrate for every transistor. At the same time, the vertical thermal coupling between the base layers and metal routing has also increased due to higher metal densities at 7nm. These thermal characteristics lead to localized self-heating for both devices and metals, accelerate lifetime degradation and impact device performance.

The amount of time designers spend on fixing EM violations has been creeping up with every new process node — 7nm is no exception. This is mainly due to the margin-based EM sign-off approach using the worst-case temperature. Overdesign by using wider metals and more vias to solve EM violations has an unintended consequence of poor routability. Using ANSYS RedHawk-CTA for thermal-aware statistical EM sign-off, designers can reclaim valuable chip area and time spent on fixing false EM violations. This can significantly reduce the risks for schedule slips.

Device aging and variability is yet another area of importance for the 7nm process node. Understanding the effects of negative bias temperature instability (NBTI) and hot carrier injection (HCI) on device aging and performance is an important check for all FinFET nodes. Studies have shown a strong relationship between signal probabilities and aging-based performance degradation. Capturing this behavior requires detailed modeling of NBTI-aware libraries and signal probabilities across multiple workloads at the SoC level. ANSYS Path FX and ANSYS Variance FX can perform variability-aware and

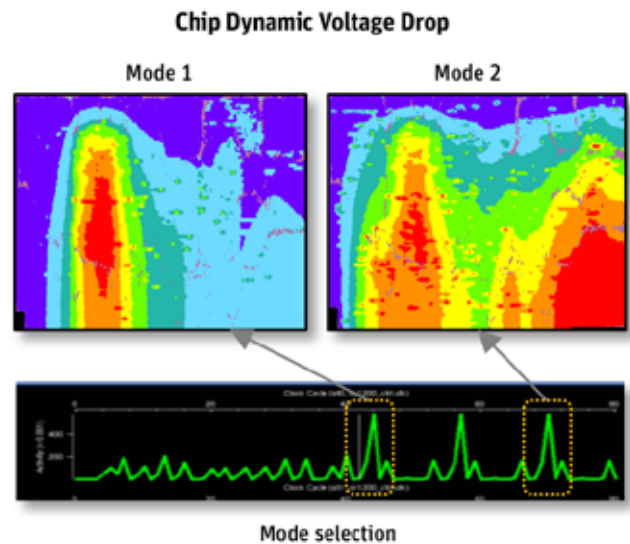

▲ Multimode, multicycle vector coverage using ANSYS RedHawk-SC

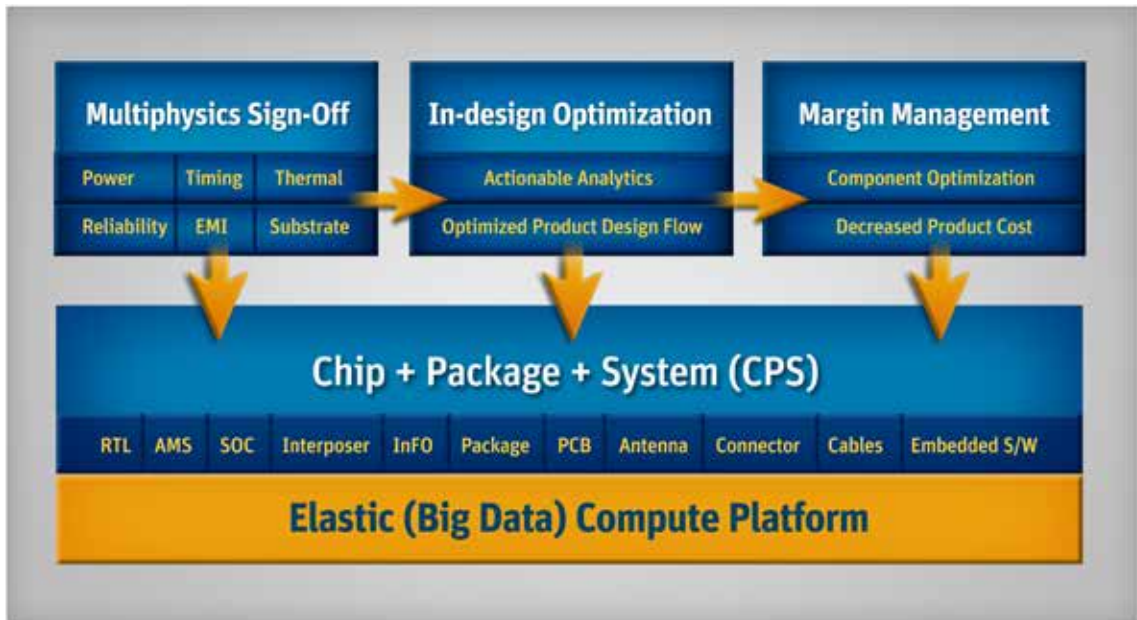

▲ ANSYS SeaScape platform for chip–package–system convergence

aging-aware timing simulations to increase sign-off confidence for the 7nm node.

**MODELING USABLE ACCURACY**

With diminished noise margins at 7nm, accuracy in modeling foundation IP and logic libraries cannot be compromised. Standard cells should be characterized at a wide range of voltage levels to capture the ultra-low-voltage effects on current consumption. Multi-bit flip-flops (MBFFs) should have accurate bit-wise currents with support for spatial allocation of current sinks. Larger analog IPs and memories should have accurate transistor-level detail for proper current distribution. Accurate channel modeling of the on-chip power delivery network along with the package and board model is also mandatory for 7nm sign-off. On-chip extraction tools should have support for multi-color-aware double and triple patterning rules and be foundry certified. Additionally, package modeling should support full-wave accuracy at a bump resolution to capture spatial variabilities. Platforms such as ANSYS RedHawk

Histogram of peak-to-peak voltages across 26 switching combinations of 4 CPU cores

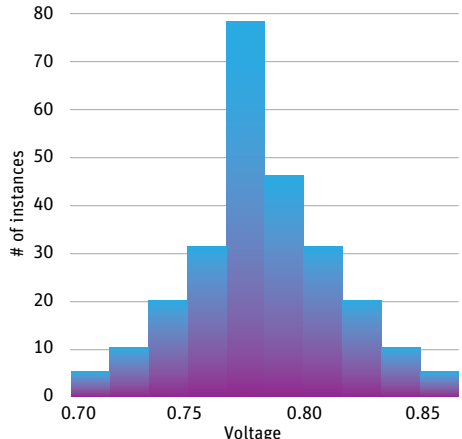

<10 hrs to evaluate more than 3,000 switching scenarios

▲ Rapid design exploration for thousands of scenarios

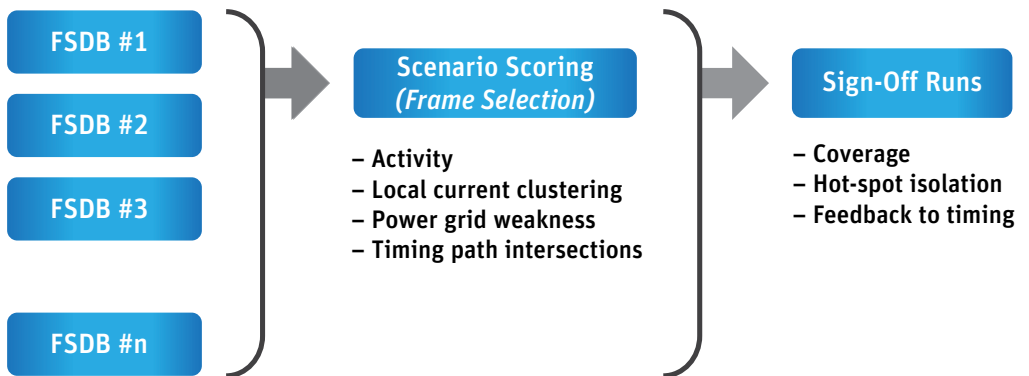

▲ Critical vector selection based on multiple parameters

“One benefit of using a 7nm process node is the ability to operate at a much lower supply voltage without compromising performance.”

and ANSYS RedHawk-CTA provide foundry certified extraction rules as well as the necessary accuracy for package modeling.

### BREAKING THE SILOS

Timing, functionality, power noise and reliability closure are all different stages in the verification process of a chip and typically have a siloed approach toward sign-off. Margining and overdesigning for these verification steps have worked well at older technology nodes without much impact. However, for 16nm and 7nm nodes, the amount of time spent on these independent verification steps has gone up significantly, affecting actual project schedule and cost. For instance, the interdependency of power noise on timing closure has gone up significantly at 7nm. Similarly, the interdependency of self-heat on EM or device aging on timing closure has also increased. If design teams are not adopting new methodologies, verification silos will quickly risk schedule and cost. Platforms such as ANSYS SeaScape that can provide the rapid simulation coverage and bridge the analytics gap across all these silos will be necessary to avoid overdesign at the 7nm node.

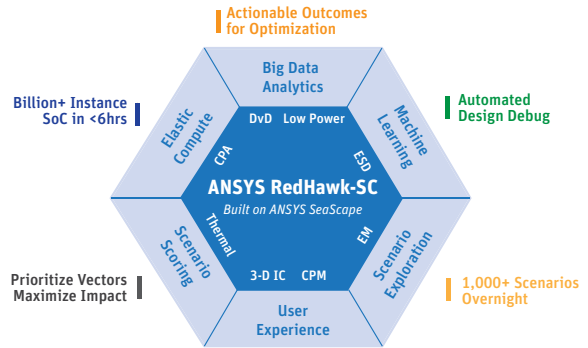

▲ ANSYS RedHawk-SC platform

### ANALYTICS TO THE RESCUE

The ability to create actionable information from vast amounts of simulation data is an important part of 7nm design closure. Traditional tools lack the ability to morph metrics from different tools into a change action. For instance, trying to avoid low-timing slack paths going through a high-dynamic voltage drop area would require the knowledge of all timing paths along with all voltage drop scenarios. Similarly, trying to find instances that have a high peak current and a high resistive path requires knowledge of the effective resistance map along with the instance load versus current models. Using a targeted design-fixing approach with these analytics is a much more efficient way to fix issues at 7nm than a shotgun approach. Design teams can fundamentally improve the way design closure is done using a purpose-built analytics platform such as ANSYS SeaScape, which is built on a scalable big-data architecture, for multiphysics optimizations.

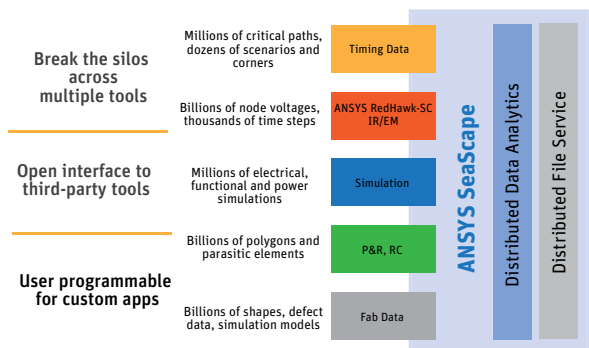

▲ Breaking the silos using the ANSYS SeaScape platform

### SUMMARY

The risk versus reward in moving to the 7nm process node can be quite daunting for IC design teams. Designers must fundamentally rethink implementation and verification methodology to tackle multiphysics problems through innovative analytical means. Breaking down the silos between power noise, timing, thermal and reliability issues is the only way forward without overdesigning. Design teams must retool and rethink design processes to meet the inevitability of process migrations. ⚠



**ANSYS SeaScape — A Big Data Approach to Complex Chip Design**  
[ansys.com/seascape-big-data](https://ansys.com/seascape-big-data)



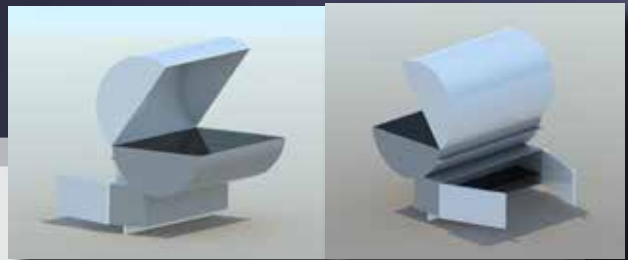
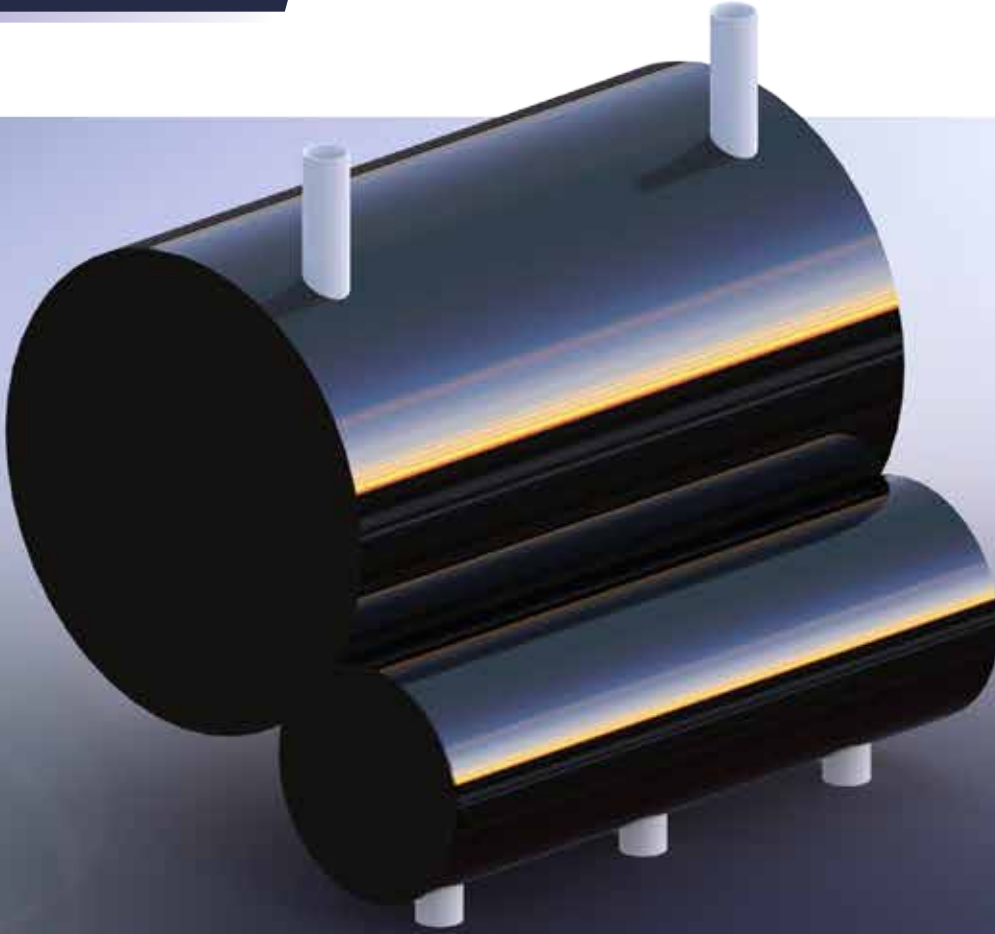

## *Cooking with* **ANSYS SpaceClaim**

By **Travis Jacobs**,  
President,  
Jacobs Analytics,  
Denver, USA

When Jacobs Analytics started designing a barbecue smoker, it took two weeks using traditional solid modeling to create a single design iteration ready for computational fluid dynamics (CFD) simulation. Since switching to ANSYS SpaceClaim, the company can now edit the design to create a new iteration in only five minutes. After generating and simulating about 500 designs, the design and engineering company finalized a version that offers substantially higher performance than existing smokers.

“Jacobs Analytics streamlined the design process by using ANSYS SpaceClaim and simulation to generate new design iterations early in the design process, in a fraction of the time required in the past.”

Under ideal conditions most barbecue smokers work very well to cook delicious meat. But, when the wind blows strongly, the smoke is sucked out and the temperature inside the smoker varies drastically from too hot to too cold. The result is meat that is either over or undercooked with not enough flavor. Jacobs Analytics is a startup design and engineering company where president and engineer Travis Jacobs performs all functions.

As a barbecue enthusiast, Jacobs was inspired to use CFD to design a smoker that could cook meat to perfection in any weather. When the project began, he used a popular parametric solid modeling package to define the geometry of each design iteration. This was time-consuming because he needed to work around feature dependencies in the model, repair artifacts produced as a by-product of the translation to a neutral file format for analysis, and create a fluid volume for each design iteration.

He was inspired to use ANSYS SpaceClaim to modify the fluid volume for ANSYS CFD and so enrolled in the ANSYS Startup Program. As a small company, Jacobs Analytics does not have the funds to create a large number of physical prototypes; digital exploration through SpaceClaim can create many new design iterations to determine the best design long before the prototype stage. Modifying fluid or solid geometry is much faster with SpaceClaim than with a conventional solid modeler because any feature can be edited without contending with the network of interdependencies in a parametric solid model. Using digital exploration guided by CFD results, Jacobs iterated to a design that maintains a high level of smoke and a uniform internal temperature regardless of weather conditions.

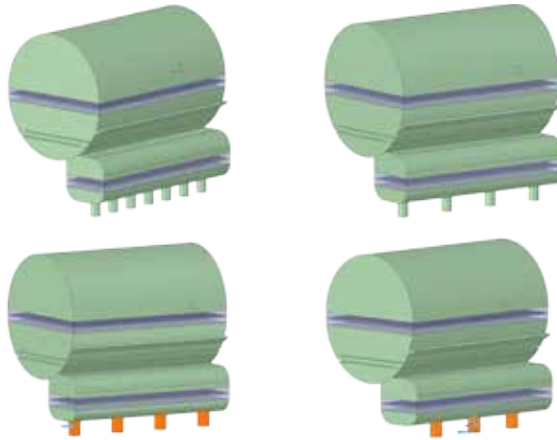

▲ Jacobs Analytics digitally explored many designs before determining the best configurations. Only a portion of the designs for the number and shape of inlets is shown.

#### LIMITATIONS OF EXISTING SMOKERS

The typical barbecue smoker consists of a 4-foot-long, 2-foot-diameter cylinder with a removable pan at the bottom to insert wood or charcoal. Racks are distributed vertically through the smoker to hold meat while it cooks. Air enters through vents in the bottom and exits through outlets near the top of the smoker. This design works well in calm weather, but under high winds too much air enters the inlets and

swirls through the smoker, removing the smoke and causing severe temperature variations. Some dedicated cooks build enclosures around their smoker, but this is expensive and takes up considerable space.

Jacobs wanted to include flow restrictors in the inlets and outlets to maintain the internal flow regime regardless of the weather. The company also planned to incorporate a double wall in the smoking box to provide insulation to maintain the internal temperature. Getting this much more complex design right in a reasonable amount of time required using simulation to explore many different design iterations.

#### IMPROVING DESIGN PROCESS

In the past, Jacobs created designs as solid models and exported the geometry in neutral file format for CFD simulation. The process of editing the solid geometry was slowed by the difficulty of changing geometry that was not originally configured as a parametric variable; it could only be changed indirectly by changing its parent geometry. Limitations in the accuracy of the process of translating from CAD to the neutral file format often resulted in the creation of many tiny fragments that had to be manually combined or removed in the CFD preprocessor. This entire process,



**ANSYS SpaceClaim: Try It Now**  
[ansys.com/tryspaceclaim](https://ansys.com/tryspaceclaim)

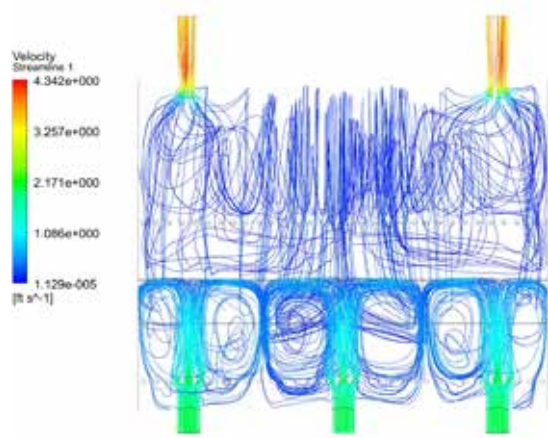
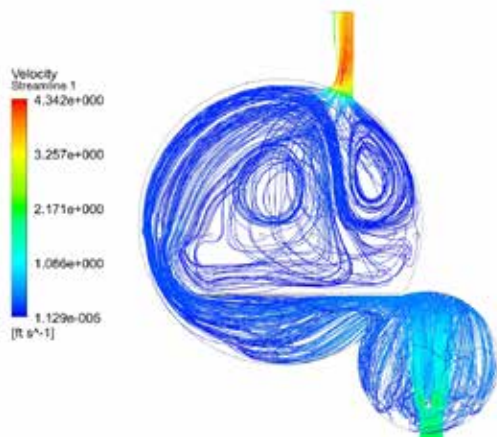

▲ Side view (left) and front view (right) of CFD flow streamlines for a smoker design iteration with three inlets at the bottom and two outlets at the top

which took about two weeks, had to be repeated for each design iteration.

Jacobs reduced the time required to create a new design iteration by editing the design geometry in ANSYS SpaceClaim instead of a parametric modeler. SpaceClaim uses direct modeling technology to create and modify any element of the design. The network of constraints is replaced by feature recognition that intelligently determines which individual entities the user wants to edit. For example, the engineer can select the end of a pipe and pull it to lengthen or shorten the pipe. SpaceClaim also generates geometry in the native

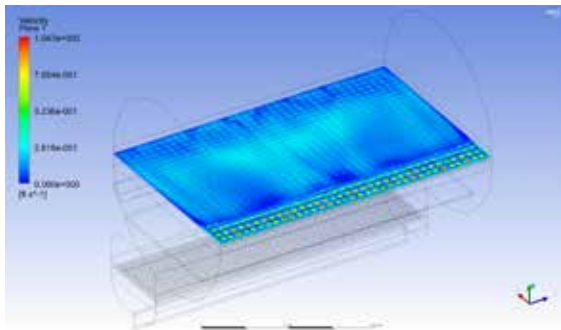

▲ Velocity profile over horizontal cross-section for the final smoker design. The final design has one long skinny inlet on the bottom and one long skinny outlet at the back angled at 30 degrees upward.

format used for simulation, avoiding translation errors. This helped Jacobs reduce the time required to create a new design iteration to only two days.

After about a dozen iterations, the engineer decided to further improve the design process by editing the fluid geometry directly in SpaceClaim, thus avoiding the need to deal with the solid geometry after the first design iteration. This process change reduced the time to create a new design iteration to about five minutes.

## SIMULATION GUIDES DESIGN IMPROVEMENTS

After creating each design iteration, Jacobs used ANSYS Meshing to create a tetrahedral mesh with inflation layers around the smoker and about 30 million nodes. The smoker was simulated within a much larger design space so that air currents could be created in the surroundings to simulate the effect of wind on the smoker. Jacobs created a flow velocity inlet on one face of the cube and a pressure outlet on the opposite face so he could evaluate the effect of changes in wind velocity on the flow patterns inside the smoker. He modeled the effects of different wind directions by changing the orientation of the smoker with respect to the wind.

With the analysis workflow optimized, Jacobs Analytics focused on optimizing the geometry of the smoker to achieve constant vertical flow velocity, uniform flow velocity across each horizontal cross section, and uniform temperature inside the smoker regardless of ambient wind velocity, wind direction or temperature. Jacobs experimented with different types of flow restrictors and tried them under a wide range of wind conditions. He saved time in evaluating flow restrictors by simulating only the inlet and flow restrictor, which took 15 minutes compared to the six hours it would have taken to run the complete model. The best flow restrictor designs were then simulated with the full model. Through the ANSYS Startup Program, Jacobs Analytics streamlined the design process by using ANSYS SpaceClaim and simulation to generate new design iterations early in the design process, in a fraction of the time required in the past. This made it possible to create a design that delivers optimized cooking performance regardless of the ambient weather conditions. The company is currently testing the new design and preparing to bring it to market. ▲

# Electrifying VEHICLE

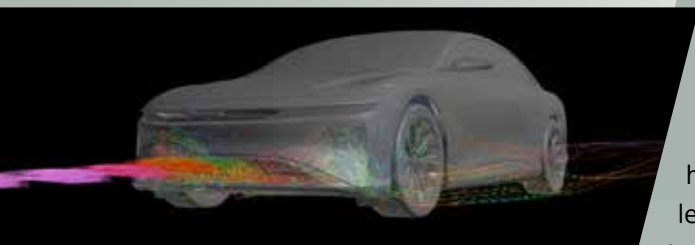

▲ ANSYS Fluent was used to optimize vehicle aerodynamics.

simulation platform was critical to facilitate cooperation across the many different engineering disciplines on the design team, resulting in a wide range of performance improvements — both for the car and the engineering team.

By **Alberto Bassanese**, Manager,  
Multiphysics and Optimization,  
Lucid Motors, Menlo Park, USA

In developing a new high-end EV from scratch in just a couple of years, Lucid Motors faced enormous technical challenges, a complex regulatory environment and competitors with up to a century head start. However, being a new entrant also gave Lucid some key advantages as it was able to adopt best-in-class practices without being hindered by legacy methods. The company pioneered a unique approach, housing the teams working on each discipline involved in electric vehicle design – electromagnetics, thermal, structural, aerodynamic, etc. – in a single room to encourage collaboration from the beginning of the design process. Lucid further promoted teamwork and expedited the engineering process by equipping most of the engineering team with a common simulation platform: ANSYS multiphysics simulation software integrated in the ANSYS Workbench environment, which enables simultaneous optimization of all the different subsystems of the vehicle. This approach is making it possible for Lucid to address customer needs, solve engineering problems, optimize subsystems and components, meet regulatory requirements, and bring a world-class vehicle to market in a fraction of the time required by a conventional approach in which engineers work with different simulation tools in different and segregated disciplines.

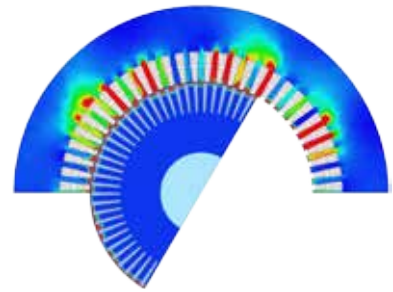

▲ ANSYS Maxwell core losses were mapped into ANSYS Fluent to improve the motor design.

*“ANSYS multiphysics simulation platform helps Lucid to address customer needs, solve engineering problems, optimize subsystems and components, meet regulatory requirements, and bring a world-class vehicle to market.”*

### REDUCE DRAG

Lucid aerodynamics engineers used ANSYS Fluent – the key computational fluid dynamics (CFD) software within the ANSYS simulation platform – including the ANSYS Adjoint Solver to develop a vehicle body, and a new air intake and duct system to minimize the drag coefficient. The engineers leveraged ANSYS DesignXplorer, the advanced parametric analysis tool that is part of the integrated ANSYS platform, to drive the CFD software to simulate a broad range of vehicle shapes to determine aerodynamic performance. These simulations provided detailed guidance about the specific effects on drag of numerous shape parameters in the form of response surfaces, sensitivity charts, Pareto plots and trade-off plots. Armed with this information, stylists and aerodynamicists identified the vehicle shapes that yield the least possible drag while adhering to styling themes and other constraints.

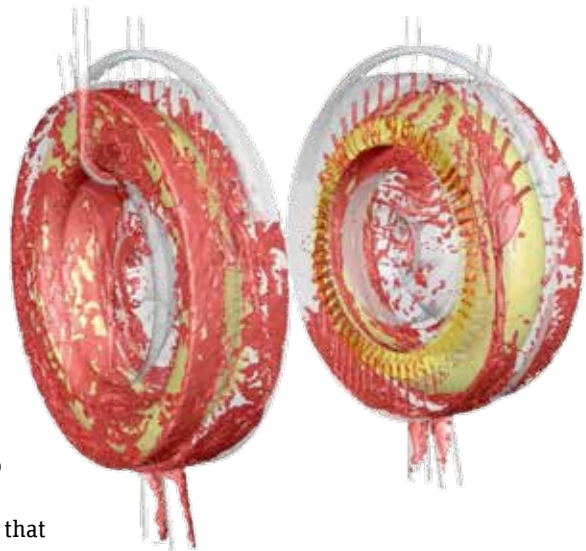

▲ ANSYS Fluent multiphase volume of fluid oil-cooling transient simulation

### OPTIMIZE THE MOTOR

The Lucid team utilized ANSYS Maxwell – the electromagnetic field simulation software within the ANSYS platform – for the design and analysis of electric motors, actuators, sensors, transformers, and other electromagnetic and electromechanical devices. Maxwell determined electromagnetic losses in the motor and, through ANSYS Workbench – the host environment and data exchange backbone of the ANSYS simulation platform – integrated these losses with an ANSYS Fluent

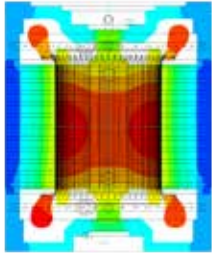
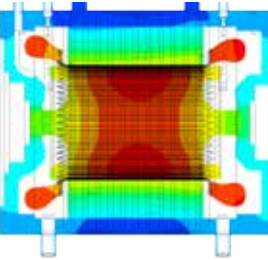
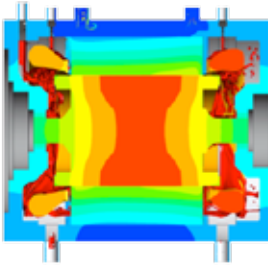

▲ ANSYS Fluent conjugate heat transfer simulation temperature contour plot

simulation to determine temperatures throughout the motor. Two separate systems cool the motor. The first is a water jacket molded into the motor case. In the second system, transmission oil is injected into the hottest areas — the end windings and rotor. Engineers used two coupled models, an oil model and a water model, to simulate these two cooling systems. Multiphase transient analysis with the volume of fluids model was used to solve the domain cooled by oil in the oil model. This model produced heat transfer coefficients of the surface wetted by the oil and the local oil temperatures. Engineers modeled the water cooling system with a water model in ANSYS Fluent that used steady-state conjugate heat transfer to predict temperatures of the solid components of the motor.

The temperatures predicted by the water model were then used with the oil model and the simulation was run again. The resulting heat transfer values were mapped to the water model. This iterative process continued until the two models converged on the same temperatures. After the models converged, ANSYS Workbench enabled the engineers to easily incorporate the temperatures of the solid objects into an ANSYS Mechanical structural model to calculate thermal stresses and, finally, to perform fatigue analysis to ensure that the motor will deliver its promised life. Using simulation, Lucid engineers increased the power density and energy efficiency of the motor by 12 percent. The temperature predictions matched physical measurements within a 3 percent margin of error.

Another important aspect of motor design was to create the rotor flux map, which is embedded into the control algorithm and used to minimize motor losses under different operating conditions. Engineers employed ANSYS Maxwell and the ANSYS Electric Machine Design Toolkit, which computes torque speed curves, efficiency maps and other performance curves for electrical machines. They varied parameters such as frequency, slip and input current to calculate the rotor flux map and embedded it into the control algorithm as a lookup table. The fluxes are translated to pulse width modulation (PWM) voltages during operation of the vehicle. Compared to the normal approach of generating the rotor flux map with experiments on a dynamometer, this approach cut dynamometer calibration time by 80 percent.

### COOL INVERTERS

The inverters convert low voltage DC to high voltage AC to power the vehicle; this generates huge amounts of heat that needs to be removed to avoid exceeding the

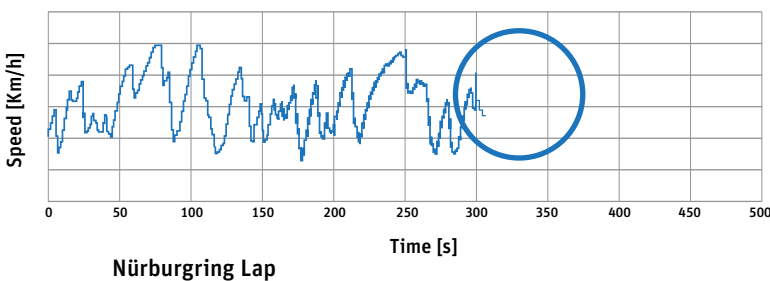

Nürburgring Lap

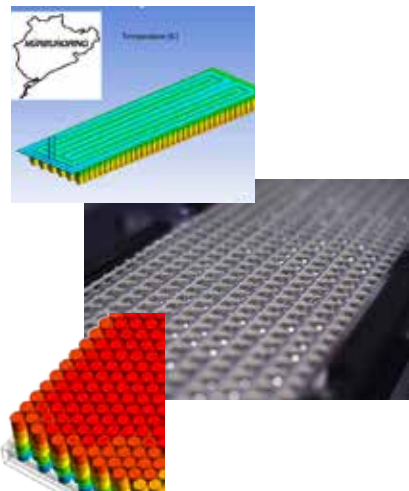
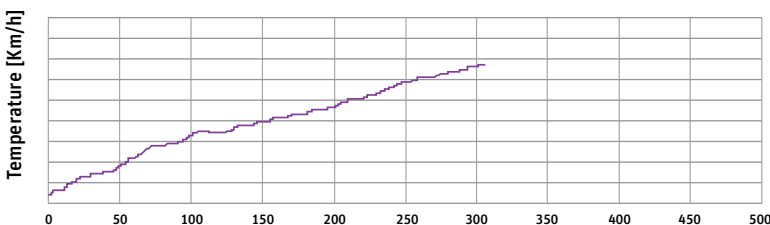

▲ Engineers modeled the transient thermal performance of the battery using ANSYS Fluent and ANSYS Simplorer over a lap of the Nürburgring Grand Prix race track.



“Simulation enabled Lucid engineers to increase the power density and energy efficiency of the motor by 12 percent.”

junction temperatures of the inverters and destroying them. Engineers created a fully parameterized model of the inverters and used modeFRONTIER, a third-party optimization software that interfaces with the flexible ANSYS platform, to optimize key design parameters such as the fins' topology and the cross-sections of the channels that move water through the inverter housing. They then leveraged the ANSYS Adjoint Solver to optimize by mesh morphing the shape of the manifolds connecting with the upstream and downstream piping. This process reduced peak temperatures by 18 C while maintaining the temperature of the different power transistors within 4 C of each other. At the same time, the pressure drop in the cooling system was reduced by one-third, and the volume and weight of the inverter housing was reduced by 15 percent.

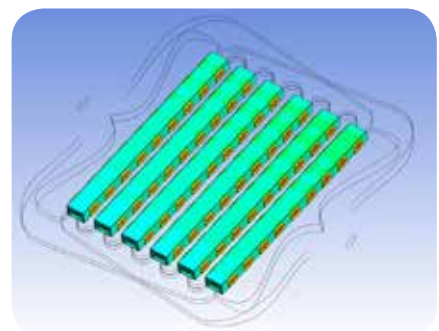

▲ ANSYS CFD shows that inverter temperature distribution is even across different IGBTs.

### INCREASE BATTERY LIFE

Lucid engineers also created electrical and thermal models of the battery pack using ANSYS Mechanical – the structural mechanics solver in the ANSYS simulation platform – and ANSYS Fluent coupled within ANSYS Workbench to simulate electrode degradation during charging and discharging of the battery. By understanding the potential conditions that could degrade the electrodes during different drive cycles, engineers substantially increased the life of the battery. The simulation results were condensed into reduced-order models that are used to simulate battery performance under drive cycles, such as a lap at the Nürburgring race track.



Powering Lucid Motors with ANSYS  
[ansys.com/lucid](https://www.ansys.com/lucid)



▲ Using a sculpted battery pack allowed for a roomier interior.

“Lucid’s pervasive use of simulation throughout the design cycle along with their dedication to upfront simulation has positioned the company for success.”

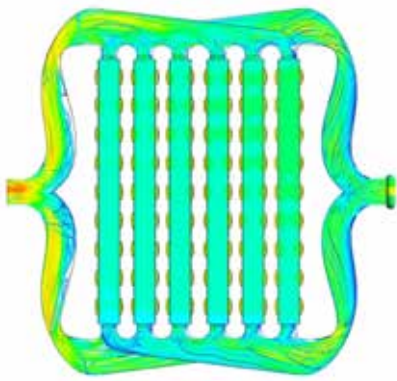

▲ Simulating the inverter cooling system with ANSYS CFD

Simulation enables engineers to improve key vehicle attributes. For example, the conventional approach is to configure the batteries in a flat panel stacked under the car. This increases torsional stiffness and lowers the center of gravity, but it has a negative impact on legroom. Lucid engineers used simulation to reduce the size of the front inverter-motor and heating ventilation air conditioning (HVAC) units, freeing up space so that battery pack height could be increased in this area. This made it possible to sculpt the battery pack to reduce its profile beneath the passenger cabin, providing more legroom inside the cabin for greater passenger comfort.

Lucid’s pervasive use of simulation with the ANSYS common simulation platform throughout the design cycle, along with their dedication to upfront simulation, has positioned the company for success against established EV competitors. Engineers from different disciplines employ ANSYS tools within the ANSYS simulation platform to perform digital exploration that takes the complex, multiphysics nature of the design into account. As an example of the results, the exterior of the new Lucid Air is only a little larger than a Mercedes E-class vehicle, yet the new vehicle has the interior space of a larger Mercedes S-Class. Lucid is taking reservations for the Lucid Air, which is scheduled to go into production in a new \$700 million factory in

Arizona during 2019, positioning the company to deliver a best-in-class automobile in a fraction of the time required by its competitors. ▲



Advanced Design of Electric Machines Using the ANSYS Electric Machine Design Toolkit  
[ansys.com/electric-machines](https://ansys.com/electric-machines)



# Digital Exploration with ANSYS AIM

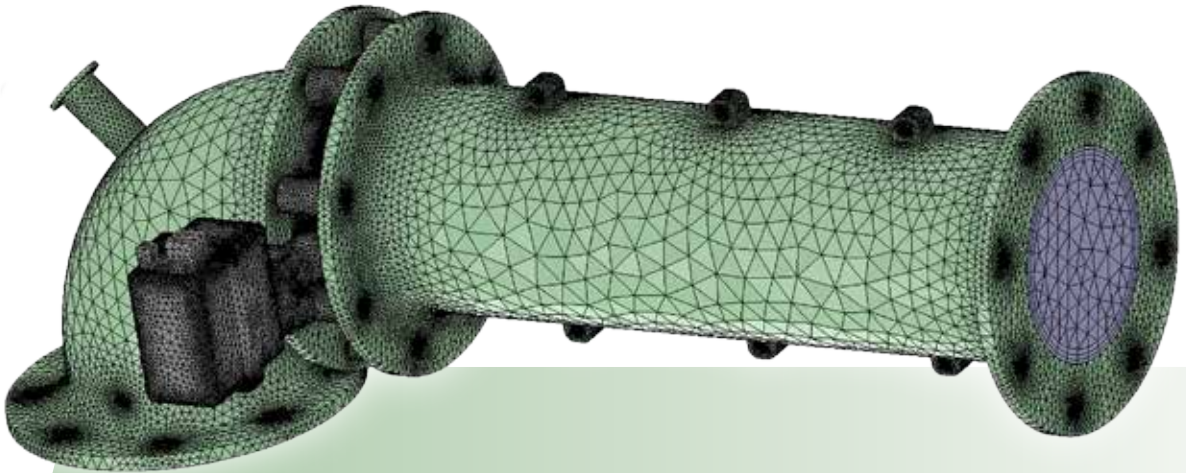

By **Steve Scampoli**,  
Lead Product Manager,  
ANSYS, Inc.

Innovative companies continually seek new ways to improve product design and reduce product development costs. Because most development costs are determined by decisions made early in the design process, many companies leverage digital exploration, often called upfront simulation, to reduce costs. By digitally exploring design concepts and testing critical design choices early in the design process, upfront simulation provides the guidance required to make informed design decisions, reduces the need for physical prototypes and avoids unworkable design concepts. ANSYS AIM makes it easy to perform digital exploration by combining unmatched ease of use, accurate simulation results and design optimization in one simulation tool.

Velocity magnitude for an automotive fuse box where the inlet boundary condition is specified using a solution-dependent expression representing a fan performance curve

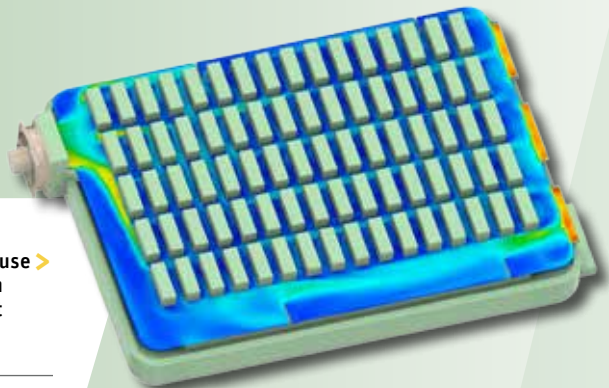

**“ANSYS AIM makes it easy to perform digital exploration by combining unmatched ease of use, accurate simulation results and design optimization in one simulation tool.”**

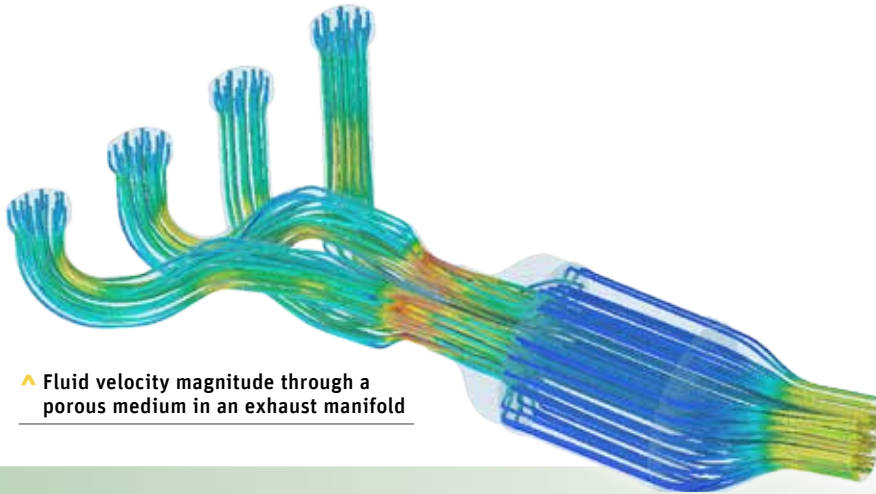

▲ Fluid velocity magnitude through a porous medium in an exhaust manifold

#### UPFRONT SIMULATION FOR PRODUCT DESIGN

ANSYS AIM integrates proven ANSYS technology. Geometry modeling (based on ANSYS SpaceClaim capabilities) enables users to quickly create new concept models or edit existing designs. By leveraging ANSYS’s world-leading solver technology, AIM provides design engineers with results they can trust, whether a simulation includes fluid, thermal, structural and/or electromagnetic effects. Depending on the product, it is often necessary to consider the flow and thermal performance, the structural integrity and/or the electromagnetic performance of the design. With AIM’s single user interface, the workflow and the user experience are consistent for all types of simulation, which makes AIM easy to learn and remember, so

that design engineers can rapidly meet any simulation challenge.

ANSYS continues to expand ANSYS AIM capabilities to cover an even broader range of product design applications. Some of the new capabilities to evaluate the physical performance of product designs, along with advancements in collaboration and customization, follow.

#### EVALUATING FLUID PERFORMANCE

A number of new features enable design engineers to quickly evaluate fluid and thermal performance. Significant enhancements include solution-dependent expressions and porous media. With solution-dependent expressions, users can easily define real-world boundary conditions acting on their designs. In many applications, fluid boundary

conditions depend on the results of the simulation itself. For example, in electronics and HVAC applications, fans provide forced-convection cooling, and designers routinely evaluate a fan’s ability to deliver the desired airflow and amount of cooling. Using solution-dependent expressions, design engineers define a pressure inlet boundary condition as a function of the mass flow at an outlet to represent the manufacturer’s fan performance curve. Accurate fan modeling allows design teams to determine the amount of airflow delivered and the amount of cooling. Solution-dependent expressions can also be used for many other applications where fluid boundary conditions depend on solution variables.

In addition, design engineers can now better understand the behavior of fluid flow through a porous medium using ANSYS AIM. Using the porous media model, users can specify a flow resistance in the porous region of the model



Multiple Physics in a Single GUI with ANSYS AIM  
[ansys.com/AiM-gui](https://www.ansys.com/AiM-gui)



▲ Equivalent stress from sequential bolt pre-tension simulation of an automobile rim  
Image courtesy SVS FEM.

to characterize the momentum loss. Many industry applications, such as flow through a filter, packed bed or perforated plate, require incorporating flow through porous media to accurately characterize the fluid performance of the design.

These and many other new fluids features in AIM can accurately evaluate key design parameters, such as fluid velocity and pressure drop, to rapidly evaluate design changes and determine optimal designs.

### EVALUATING STRUCTURAL INTEGRITY

In addition to fluids enhancements, new features in ANSYS AIM include bolted connections and nonlinear contact capabilities that enable design engineers to rapidly evaluate the structural integrity of product designs. Bolted connections are very common in construction and machine design, and are used in steel buildings, automobiles and industrial equipment. Accurately simulating bolt tightening sequences, and the resulting contact pressure and frictional stresses between the parts, is required to accurately predict the structural integrity of bolted connections and connected components. AIM's bolt pre-tension

capability allows a bolt pre-load to be specified to simulate the bolt clamping force. The subsequent shortened grip length of the bolt, the region between the bearing face of a nut and the bolt head, can be locked in place to determine the response of the bolted connection to additional structural loads. Pre-tension bolts, nonlinear contact and many other new features empower users to rapidly evaluate structural performance early in the design cycle, reducing the need to build costly physical prototypes.

### EVALUATING ELECTROMAGNETIC PERFORMANCE

ANSYS recently introduced a number of new enhancements to ANSYS AIM for the evaluation of electromagnetic performance. There is a high demand for energy efficiency in the power conversion industry. Companies also need to reduce manufacturing costs by designing electromagnetic devices that use less steel, copper and permanent magnets. Design engineers must account for increased power density and need to understand electromagnetically induced thermal losses while making these trade-offs. New capabilities in AIM include the ability to simulate magnetic frequency response and one-way magnetic-thermal coupling. With these capabilities, users can determine induced eddy/displacement currents and associated induction heating of power conversion components such as transformers, converters, insulated-gate bipolar transistors (IGBTs) and busbars. An automatic adaptive solution for magnetics ensures accuracy and allows users to focus on the design, since manual iterations to refine the mesh density are not required. AIM's guided workflow and automated adaptive solution

make it easy for those who may not be experts in electromagnetic simulation to rapidly evaluate both the magnetic and the thermal performance of their designs.

### ENABLING ENGINEERING COLLABORATION

Innovative companies require upfront simulation as part of the product development process. Simulation guidance must be integrated into the early phases of the product development process when the cost of making design changes is low, and to free up simulation experts so that they can perform product validation analysis, which often requires advanced physics. In these companies, design engineers often need to send their models to simulation analysts for final product validation simulation, or simply to confirm their upfront results. AIM includes enhancements that facilitate

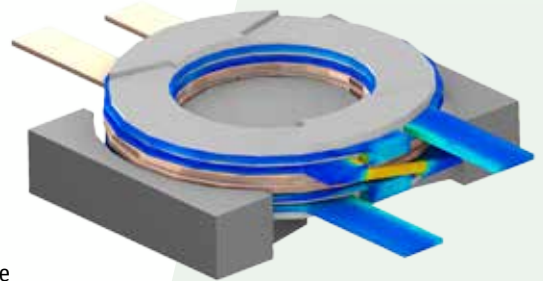

▲ Current density from a magnetic frequency response simulation of a planar transformer, including temperature-dependent material properties

engineering collaboration by enabling the transfer of simulation model data from AIM to either ANSYS Mechanical or ANSYS Fluent via an ANSYS Workbench project schematic connection. The reliable data transfer between AIM and



**ANSYS AIM: Try It Now**  
[ansys.com/tryAIM](https://ansys.com/tryAIM)

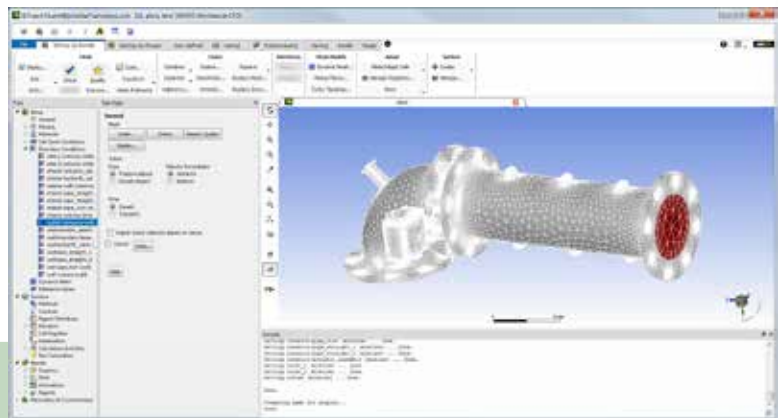
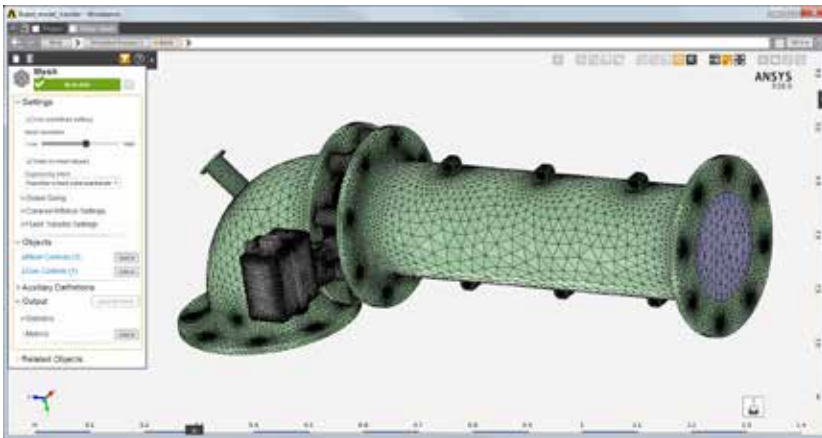

▲ Mesh and selection sets for butterfly valve model setup in ANSYS AIM and transferred to ANSYS Fluent

ANSYS flagship solver products allows designers to quickly and accurately transfer model data to analysts, which fosters engineering collaboration and streamlines the product development process.

**CUSTOMIZING SIMULATION WORKFLOWS**

In many companies, simulation methods groups define standard simulation processes, which are deployed to the broader design organizations. AIM’s customization capabilities enable methods groups to develop custom applications, which can be tailored to follow an organization’s specific simulation process and engineering best practices. Since the initial release, AIM also includes many customization enhancements, including multi-step custom applications and in-context apps to further automate the simulation process. Customization enhancements enable methods

groups to provide expert simulation guidance to design engineers who leverage upfront simulation early in the design process.

**UPFRONT SIMULATION BECOMES ROUTINE**

ANSYS AIM’s new features and enhancements enable simulation across a broad range of industry applications, such as the fluid, thermal and structural performance of valves and flow control devices; wind and fluid loads on structures; temperature and stress in heat exchangers, engine components and electronic devices; and electromagnetic

and thermal performance of transformers, converters, IGBTs and busbars. These examples represent just a few of the many applications that can be addressed with upfront simulation to determine how product designs will perform in real-world environments. ANSYS AIM’s extreme ease of use, combined with industry-leading solver technology, empower design engineers to routinely take advantage of upfront simulation across a wide range industries – making digital exploration a routine part of the product development process. ▲



Anticipating the Next Revolution in Engineering Simulation  
[ansys.com/revolution](https://ansys.com/revolution)

# DELIVERING A DIGITAL TWIN

Today's Industrial Internet of Things unfolds before our eyes as businesses leverage new and rapidly evolving technologies. The latest concept is the digital twin, which combines an industrial asset's digital and operational data with a software platform, simulation and analytics to gain insight into present and future operations. The result is improved output, reduced costs, accelerated innovation and, ultimately, a solution that is far more than a product: It is the outcome that industry demands.

By **Marc-Thomas Schmidt**,  
Chief Architect Predix,  
GE Digital,  
San Ramon, USA

The Internet of Things (IoT) has leap-frogged from consumer applications that facilitate mere interaction and collaboration. Industry leaders like General Electric (GE) extended this connectivity to operating machines. The resulting

Industrial Internet of Things (IIoT) enables commercial organizations to engage with large complex machines — wind and gas turbines, jet engines, locomotives — to improve performance, reduce downtime and accelerate new product development. But it doesn't stop there. Today's cost models for sensor technology, internet connectivity, and simulation and analytics enable connectivity to not only highly complex, capital-intensive machinery but to almost every piece of equipment in operation.

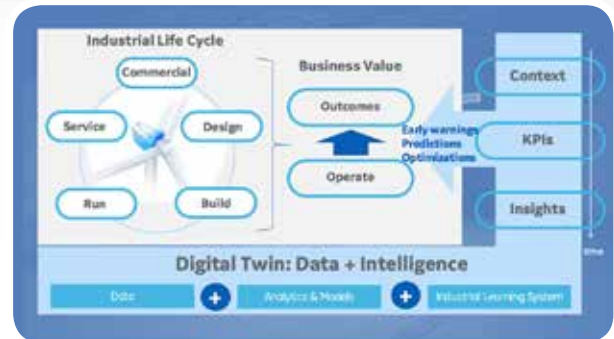

## DATA AND THE INDUSTRIAL INTERNET

The IIoT, in practice, is best used to determine or suggest an action: For example, instruct a wind turbine to tilt its rotors for optimum wind exposure. First, sensor data collected from assets are added to all other available digital information. A dashboard combines this information with the equipment's real-time and expected-performance data to produce descriptive analytics, which can be mined to forecast potential failures

▲ Digital twin industrial life cycle

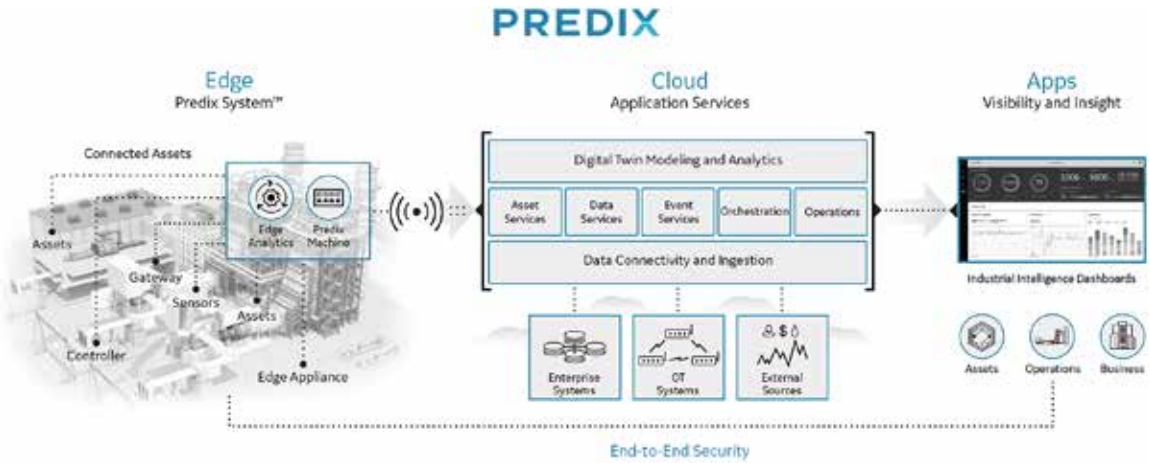

▲ Predix IIoT architecture

and schedule maintenance. The final step is optimization, which considers individual assets in all their configurations along with systems of assets to arrive at multiple solutions. The objective is to optimize a very complex ecosystem around a particular asset. The very rich models describing structure, context and behavior of industrial assets are called digital twins.

There is a cost for this improved performance: The IIoT manages huge amounts of data, extracting information and gaining actionable insights through big data analytics and deep learning. For security, and also to manage the quantity of data, some data is stored and processed locally “at the edge.” Other functions are performed on data in the cloud. This hybrid edge-to-cloud approach helps manage the quantity of data and allows the best computational approach to be taken for different types of objectives while maintaining safety and security of operation and protecting a company’s valuable IP.

“GE Digital leverages ANSYS simulation in its digital-twin use cases, so the two organizations immediately benefit from collaboration.”

**GETTING STARTED WITH A DIGITAL TWIN**

A digital twin begins with a basic model that describes the asset. For example, a wind turbine model could include PLM system information with details on materials and components, a 3-D geometric model, a simulation model that predicts expected behavior based on physics algorithms, or recommendations from analytics created using machine-learning techniques. The model also can include service logs of maintenance, and defect and solution details, capturing the entire life cycle of the asset.

Initially the digital twin represents a class of assets – in this example, a wind turbine of type x. This generic twin must be individualized for a specific wind turbine on a particular farm. Consider that the machine has operated for five years, enduring weather specific to its location, running among 50 other turbines. So the entire wind farm must be modeled. Each turbine is similar but different based on its position or experience (wind direction, maintenance record, wake effects). In the end, the twin’s rich digital representation contains its past and present condition moment by moment. The future of a specific wind turbine, in this case, is codified in that digital twin.

Digital twins provide accurate operational pictures of assets right now. There is a significant business value in identifying underutilized devices, so analyzing twin information can lead to optimal usage. For example, GE Power leveraged a digital twin to get 5 percent more output from a wind farm without making wholesale changes. The team optimized the turbines to changing wind conditions and orchestrated the interaction of individual twins on-site. One insight seemed counterintuitive: In specific scenarios,



shutting down some turbines improved output compared to running all turbines. By predicting potential problems in a fine-grained way, operators can schedule maintenance to minimize service disruption. Once the information is codified across a system of assets, the team can take that knowledge and turn it into actions that will obtain the desired outcomes.

Building a twin model at the outset is the key to creating a rich set of applications that produce asset-related outcomes — not, as some think, just developing a dashboard for equipment operator decision-making. A full-featured twin makes it easier to develop and deploy applications later. The physics, analytics and simulation information within the model pave the way for machine learning; many digital twins linked together produce a mass of actionable industrial knowledge.

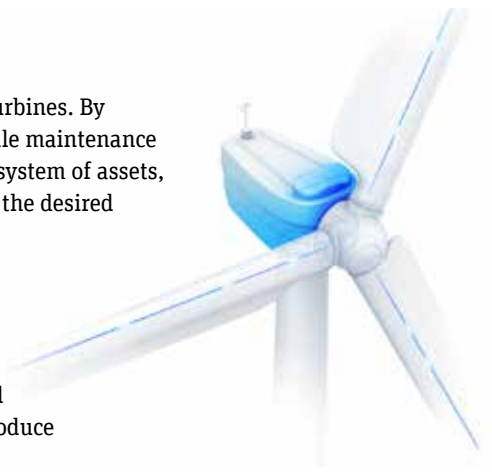

### PLATFORMS SUPPORT THE INDUSTRIAL INTERNET

The latest IIoT challenge is how to make such sophisticated technology user-friendly so end-users (who are manufacturers and engineers, but not programmers) can solve business problems.

To that end, GE has developed the Predix® platform to connect industrial equipment, analyze data and deliver real-time insights. Predix is an aggregation of microservices that are useful in building, deploying and managing industrial internet applications. Customers consult with GE Digital on business problems, such as increasing a wind farm's output or optimizing a gas turbine that services a variable-power infrastructure. Within a few weeks, these organizations assemble an initial solution to address the problem.

GE also uses the Predix platform internally to optimize its own production processes and build more efficient solutions for customers.

*“Digital twins can be practically applied in almost every industry.”*

### SIMULATION AND THE DIGITAL TWIN

For decades, GE has gathered data on many assets, such as jet engines. Combining such data with statistical models predicts what is likely to happen and when — but it falls short of determining why and how it happens. Adding in physics-based simulation is the final step to gleaning this additional insight. GE's Predix can overlay data with simulation in an industrial context that operates as a common data model. Simulations can be run on-site or in the cloud at scale — pushing models to the edge then bringing insights they create back to the cloud. Complete integration requires connecting to the customer's PLM system, linking in CAD data and other valuable information recorded in enterprise systems. A digital twin that centers on a common model and incorporates many information sources enriches knowledge.

GE Digital leverages ANSYS simulation in its digital twin use cases, so the two organizations immediately benefit from collaboration. ANSYS software's greatest value is in bringing together different aspects of simulation, so it helps designers completely think through their designs. Because a simulation model demonstrates how the assets should work, the twin approach shows exactly when operation is amiss. Digital twins take simulation results out of the design studio and into real life to provide immediate feedback on one asset or many. Soon the technology will enable optimizing an individual asset in the field; furthermore, it could be deployed throughout an asset's entire life cycle.

### THE FUTURE

Digital twins can be practically applied in almost every industry: transportation, energy, manufacturing, aviation and more. Companies already are saving millions of dollars by bringing together data, simulation, platform, cloud-based functions and machine learning. Organizations can only imagine the future benefits as the digital twin concept grows more prevalent. ▲



**ANSYS and GE Partner  
on Digital Twins**  
[ansys.com/ge-digital-twins](https://ansys.com/ge-digital-twins)

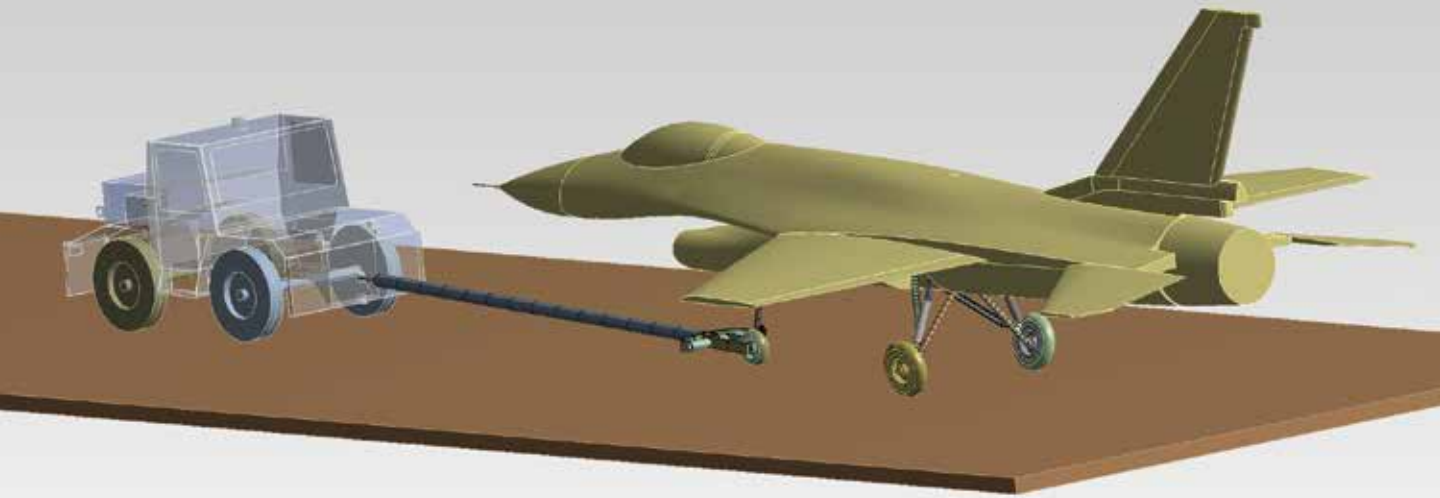

# Hitting the Brakes

United States Air Force jets were being damaged when the tow tractor that transports them around bases came to a sudden stop. An Air Force engineering team used ANSYS Mechanical to determine the cause of the problem and devise a simple solution to this multimillion-dollar problem.

By **Andrew Clark** and **Jared Butterfield**, Lead Structural Analysis Engineers, United States Air Force, Hill AFB, USA

Because affordability is one of the key mantras of the U.S. Department of Defense, and engineering for sustainability initiatives (to optimize operational availability of assets while controlling costs) is growing in importance, engineering simulation is playing an increasingly significant role.

This is certainly the case at the United States Air Force (USAF). Before a fighter jet can take off to perform its mission, it must be towed from the maintenance shed to the hangar, from the hangar to the taxiway, etc. USAF lightweight jets experienced mechanical damage after impact loads from a tow bar connection exceeded design limits during a sudden stop by the tow tractor. It has been estimated that a single failure of this type can cost upwards of a million dollars. The aircraft sometimes overhangs the tow tractor, so this type of incident has the potential to cause death or serious injury to the tow tractor operator, not to mention damage to and loss of

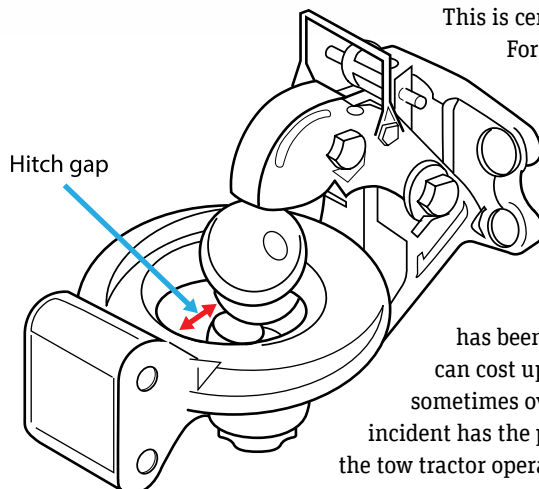



# “Fifteen separate transient *dynamic analyses* were completed to simulate the *various combinations* of factors.”

operational capability for the aircraft. Engineers were puzzled because the drag-brace assembly — the landing component that originally failed in these accidents — should have been designed to withstand known tow-bar loads. Physical testing of the aircraft was of limited use in determining the cause of the problem because an actual aircraft could not be risked in a test. The USAF team solved the problem by simulating a wide range of braking incidents to determine the conditions under which the drag-brace assembly could fail so they can be avoided in the future.

path load overcomes the downlock link lug, causing the drag brace assembly to fail catastrophically.

Next, engineers performed a multibody simulation using the ANSYS Mechanical Rigid Body Dynamics add-on module for ANSYS Workbench to quantify the loads imparted to the drag-brace assembly when the tow tractor driver hit the brakes. They modeled the towing assembly using CAD software, then imported the geometry into ANSYS Workbench and created a finite-element model using line, shell and solid elements. Material properties including modulus

Low stress in toggle and link assemblies

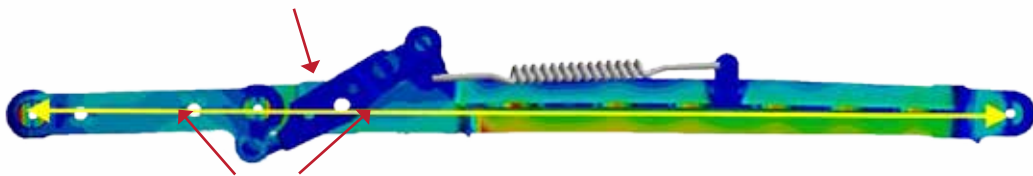

The load path is primarily through the lower drag brace into the upper drag brace.

▲ Initially, the upper drag brace bends, resulting in column instability.

## SIMULATION HELPS DETERMINE ROOT CAUSE

The USAF team first performed finite element analysis (FEA) with ANSYS Mechanical on the drag-brace assembly to determine whether or not it was strong enough to withstand the towing limit loads in the design specification. Engineers created a model of the drag-brace assembly and performed a static structural analysis that showed that the assembly is even stronger than the design specification. The actual drag-brace assembly was placed in a test fixture and loaded in accordance with the FEA simulation. The test results agreed with the structural simulation and demonstrated that the assembly indeed exceeded the design specification. Simulation and testing further defined the sequence of events that occurs during failure. First the upper drag brace bends, resulting in column instability. Next, the primary load path changes to a secondary and weaker load path involving the smaller downlock link assembly. This secondary

of elasticity, Poisson’s ratio and lumped mass or density was incorporated into the model to account for stiffness and inertial effects. Spring stiffness and damping properties were defined for the nose and main landing gear struts. These properties were applied as user-defined joints to the struts as a function of position and velocity. The tow bar was attached to the tow vehicle with a translational joint using constraint equations that simulated various sizes of hitch gap — the distance between the tow vehicle pintle hook and the tow bar ring. The tow bar connects to the drag brace assembly in the landing gear to tow the aircraft; the hitch gap is the play or slack in this connection. The stiffness of the tires of the fighter jet and tow tractor were included in the model using information provided



**Multibody Dynamics:  
Rigid and Flexible Methods**  
[ansys.com/multibody](https://www.ansys.com/multibody)

High stress in toggle and link assemblies

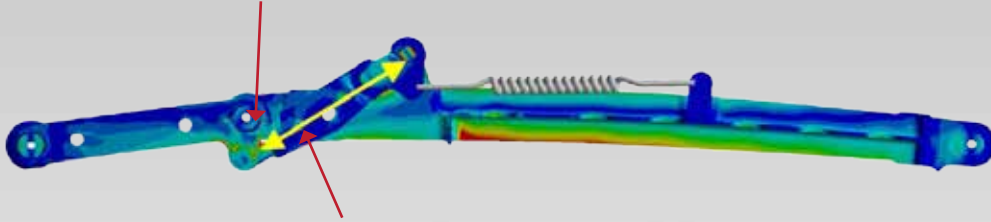

As the upper drag brace bends, the load paths shift to the down lock link.

▲ After the drag brace bends, the primary load path shifts to the down lock link assembly.

by the tire manufacturers. Engineers used time-history velocity data acquired from physical testing as an input to the simulation to increase the accuracy of the load response. Velocity and braking frictional forces were idealized as linear over time.

#### PARAMETRIC STUDY

Engineers recognized that variable impact loads could occur with different tow tractors, at different speeds, with various braking forces, under diverse operating conditions, etc. Some or all of these variables could have a major impact on the loading of the drag-brace assembly. They accounted for this uncertainty by parameterizing variables that they suspected might play a major role in the series of accidents, including tow-tractor weight, velocity, acceleration time, stopping time and hitch gap. Fifteen separate transient dynamic analyses were completed to simulate the various combinations of factors defined during the testing phase of the contract. The results from these fifteen simulations were compared against test data to validate the model.

Engineers concluded that the shape of the braking model depends upon the tow operator. This in turn affects the load response and causes significant variation from event to event. In spite of this, they determined that the maximum compressive force that

develops from the impact event was highly dependent on the hitch gap. A larger hitch gap generated higher compressive forces. The simulation showed that when the hitch gap exceeds a half inch, the collision between the tow bar and tow vehicle can generate compressive loads in excess of the drag-brace assembly's ultimate load. Further simulation iterations showed that decreasing the hitch gap reduced loads significantly across all analysis and test conditions. Engineers also determined that the weight of the tow truck had a significant effect, with heavier tow trucks generating greater loads on the drag brace assembly.

Controlling this gap was determined to be a simple and effective solution in maintaining towing loads below the allowable limit. The Air Force recommended new procedures that limit the hitch gap and mandate that only tow tractors less than a specified weight could be used to tow smaller jets. These new procedures will improve safety and eliminate damage to the nose landing gear of these expensive aircraft during towing operations.

This application provides a typical example of how the USAF is using engineering simulation to determine the root cause of performance issues so they can be quickly and efficiently resolved to save money and improve operational readiness. ▲

### \$3.6 Million Saved in Nose Landing Gear Piston Simulation

In another case, replacement of nose landing gear pistons on a Boeing 707 variant was a major expense. USAF engineers used ANSYS Mechanical for structural and fatigue analysis to identify a new thread repair method that extends the life of these parts. The static strength margin of safety was verified through simulation, and the fatigue life was verified through digital fatigue analysis. Savings are estimated at \$2.3 million in avoidance of new procurements and \$1.3 million in reduction in repair expenses in the first year of implementation alone.

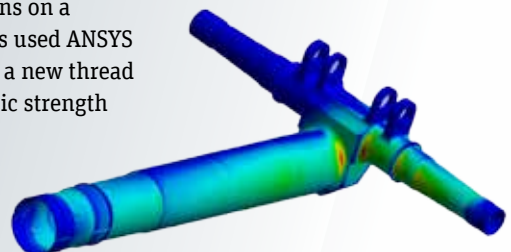

# VIBRATION POWER GENERATION

Cutting-edge simulation technology helps this startup push the boundaries of the way sensors are powered in the emerging age of the Industrial Internet of Things. ReVibe develops technology to efficiently transform ambient energy into electricity to power wireless equipment.

By **Erik Godtman Kling**,  
Chief Operating Officer, and  
**Marcus Holm**,  
Lead Product Designer,  
ReVibe Energy,  
Gothenburg, Sweden



IBM, Cisco, Ericsson and Gartner are just a few of the many industry leaders predicting that the Internet of Things (IoT) will continue its rapid expansion as the number of connected devices maintains an exponential growth path.

The biggest emerging issue with these connected devices is how they will be powered.

ReVibe Energy is a technology startup looking to revolutionize the way the IoT is powered. The company is developing a technology to efficiently transform ambient vibrations, present in all industrial environments, into electricity to power wireless equipment. ReVibe uses ANSYS software to perform upfront simulation to create the custom products that customers require.

As interest in the Industrial IoT (IIoT, also known as Industry 4.0) continues to grow, customers are becoming increasingly aware of the benefits of wireless sensor networks (WSNs) for improved process monitoring. These sensors enable completely new business models within a wide range of industries.

◀ ReVibe energy harvesters generate electricity from ambient vibration.



**AN INDUSTRY IN TRANSITION**

The increasing process monitoring in the IIoT is coupled with the growing desire for cheaper, smaller and more efficient sensors, and their associated communication protocols. Tens of sensors in today’s WSNs will quickly expand to tens of thousands.

Energy supply is one of the most pressing challenges for the IIoT. Millions (and expected soon to be billions) of connected devices require power sources to keep them running. Currently, WSNs are either hardwired or battery powered, making the sensor networks expensive to install and maintain. Battery power provides complete autonomy, but battery life continues to be an obstacle. There is a constant trade-off between the lifetime and the functionality of the sensor, which often tips in favor of “dumb” sensors with longer operational lifespans.

To address these demands, companies need unconventional power sources so that energy harvesting becomes an increasingly viable option. Many very large, global and R&D-heavy companies operating in conventional industries are not yet aware of the numerous locations where smart sensors could be added to their processes to help them realize the power of the IIoT and digital twins. This is where ReVibe Energy comes in. The company is creating a new market and has the speed and flexibility to compete with well-known brands that have 80-plus years of experience but may not innovate quickly with the changing market.

**ONE SIZE DOESN'T FIT ALL**

Until recently, vibration energy harvesters were limited in application, as they could not produce sufficient energy to power most wireless devices. Now, with increasingly efficient communication protocols and lower power demands from many electrical components, there are new opportunities for these devices.

There are several technological challenges for vibration energy harvesters. These units are often tuned specifically for the environment in which they are intended to be used. Variations in the frequency and amplitude of the surrounding vibrations negatively affect these units, which produce the most energy at a specific resonant frequency. Even when properly suited for their environment, these energy harvesters only produce enough energy to power the wireless application.

In a recent typical customer case, ReVibe Energy proposed an energy harvesting solution for a railway application. The harvesting device powers a sensor mounted on the railway tracks monitoring remote and off-grid switches. Such a case typically begins with the customer providing information about the vibration environment and specifications about the wireless application. From here, ReVibe Energy needs to quickly estimate the design parameters and the power output from a product that does not yet exist. This calls for very short iterations and testing loops.

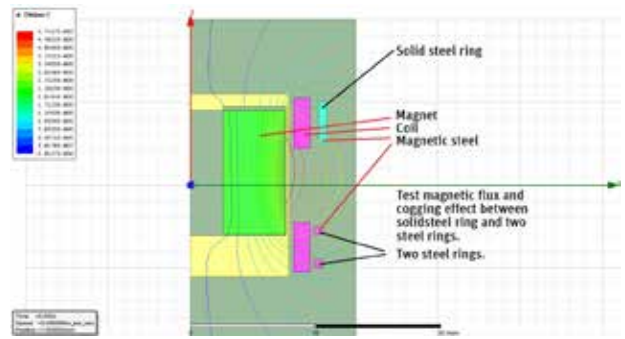

▲ Placing metal parts on the other side of the coil (cogging) affects the magnetic field. This example shows two small rings and a larger ring.

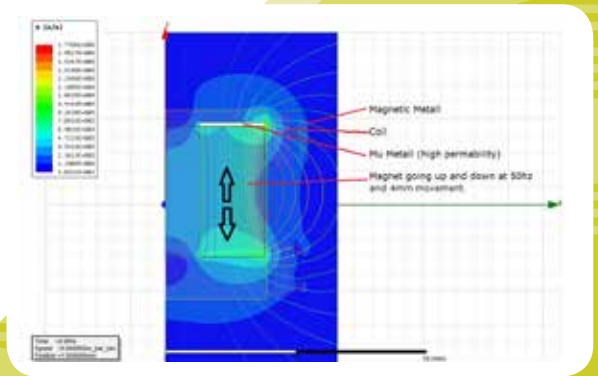

▲ ANSYS Maxwell simulation of the magnet and coil

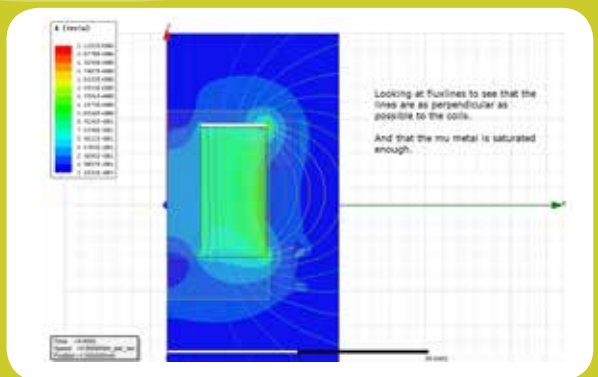

▲ ANSYS Maxwell allows engineers to ensure that flux lines are parallel to the coil and that the Mu-metal is sufficiently saturated for optimal energy generation.

## CUSTOMIZING PRODUCTS WITH SIMULATION

ReVibe Energy's patented vibration energy harvesting technology builds upon electromagnetic induction through a system of mechanical springs attached to a magnet oscillating at its resonant frequency.

ReVibe joined the ANSYS Startup Program in 2015 to provide the company's engineers with access to a wide range of ANSYS simulation capabilities and allow them to quickly provide customers with information about the intended solution and reduce development time. They employ ANSYS Mechanical to determine the displacement of the magnet array in relation to the surrounding coils, given a certain vibration frequency and amplitude. It is also used to specify the exact frequencies for all of the system's different resonance modes.

Because product lifetime is crucial when competing with batteries, they also leverage ANSYS Mechanical for structural analysis of the sophisticated spring system. To ensure maximum durability, the simulation model can identify fracture and fatigue points. Based on the displacement information obtained from ANSYS Mechanical, the internal coils can be optimized with regard to geometry.

The engineers apply ANSYS Maxwell to manually optimize several of the unit's parameters related to the magnet, the coil and the amount of Mu-metal (a nickel-iron metal with high permeability for shielding the unit from external magnetic interference) used. The magnet variables include its size and its displacement distance and velocity. Coils are optimized for the number of turns and wire diameter to ensure the right voltage level for rectification electronics. Engineers also employ ANSYS Maxwell to study magnetic flux to properly size the magnet array and to determine the level of magnetization in relation to the oscillating mass. Each parameter change is quickly simulated before modifying the model, with simulations typically taking 10 minutes or less.



“ReVibe Energy is developing a technology to efficiently transform ambient vibrations, present in all industrial environments, into electricity to power wireless equipment.”

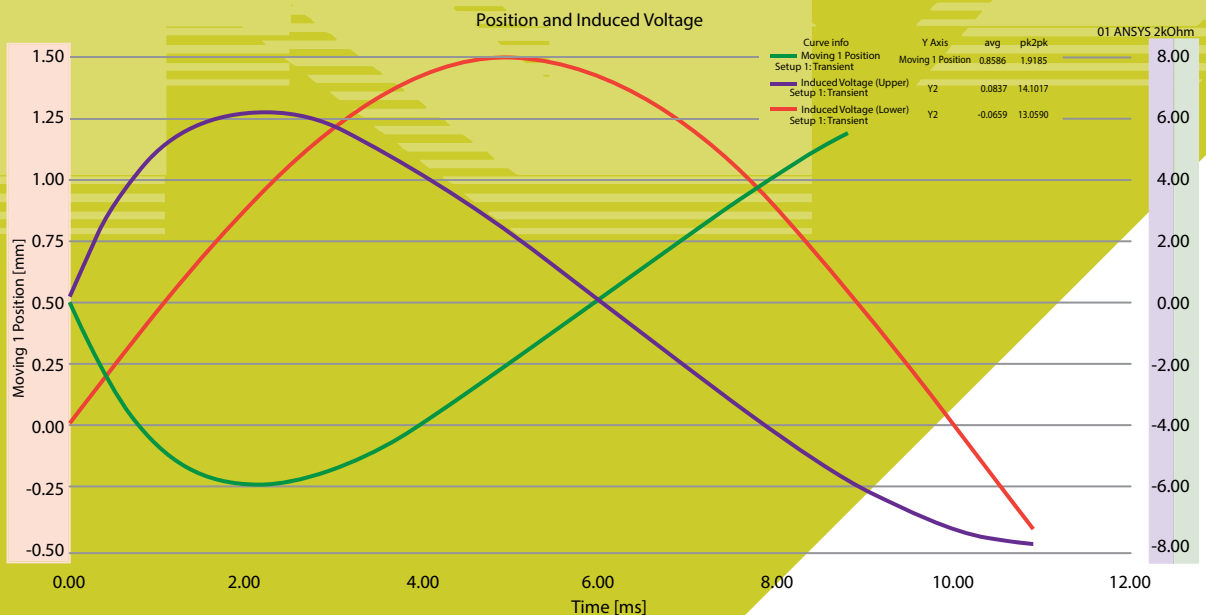

▲ Using ANSYS Maxwell ReVibe can gauge voltage output and determine where to place coils.

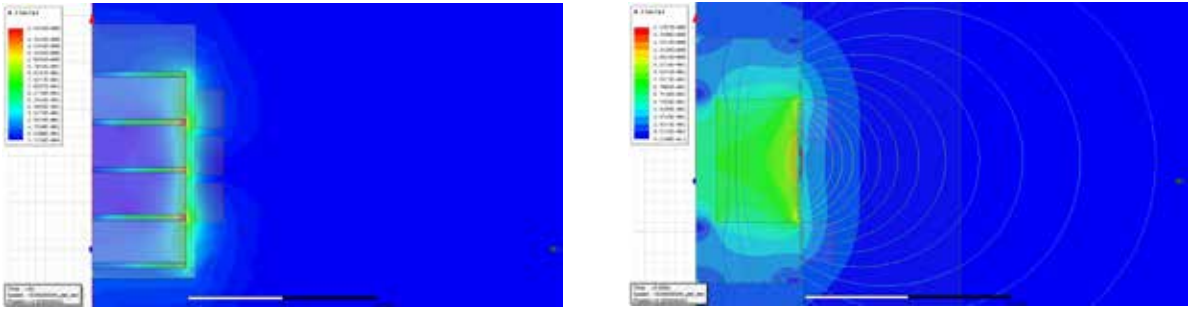

▲ Flux density determined with ANSYS Maxwell

## DIGITAL PROTOTYPES

ReVibe Energy leverages ANSYS simulation for digital prototyping to make it easy to develop a new energy harvester for a specific application. Using vibration data from a customer application, simulation is performed with ANSYS Mechanical and Maxwell; engineers then determine design parameters and expected power output for a specific harvester. By using the results of simulation and working with strategic suppliers and additive manufacturing techniques, ReVibe Energy has extremely short product design iteration loops. It usually takes only one to three weeks to produce prototypes that are designed to function and look like the final product. After testing and evaluating one or more units in a relevant environment, the customer will have enough information to make a decision about further development leading to manufacturing. Prior to integrating simulation into the product development cycle, the company required 16 weeks to develop a prototype.

In the case of the railway customer, ReVibe Energy quickly designed and manufactured a vibration energy harvester based on the vibration characteristics of a train passing over the railway switch. Without ANSYS solutions, this would have taken several additional iterations and considerable time and money. As customers and application areas are so diverse, digital prototyping allows ReVibe Energy to quickly adapt to customers' specific requirements, which is vital to the company's business model.

ANSYS simulation software obtained through the ANSYS Startup Program is already a key contributor to ReVibe Energy's value proposition, but ReVibe wants to advance this relationship even further. They are working to develop a black box, which would contain a fully coupled multiphysics simulation model. The black box will include CAD modeling in ANSYS, along with real-time simulations integrating the entire system. Developing this complete solution is a challenge, but the goal is to have a product that begins with an ANSYS CAD model, is tested and simulated in ANSYS software, and is eventually printed as a fully functioning final product via a multimaterial 3-D printer. ▲

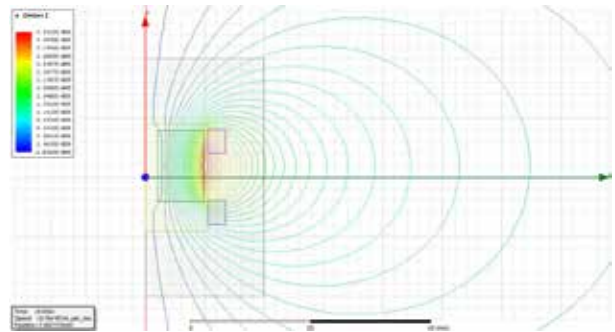

▲ ANSYS Maxwell simulates the magnetic field so that ReVibe can determine the best coil position.



Low-Frequency Electromagnetics  
[ansys.com/low-frequency](https://www.ansys.com/low-frequency)



# CLOUD SEEDS SIMULATION FOR SMES

Small and medium-size manufacturers need economical access to simulation during their design cycles to remain competitive. This requires a software stack to make it easier for these companies to expand their use of high-fidelity modeling tools on cloud computing resources.

By **Wolfgang Gentsch**,  
President, and  
**Burak Yenier**,  
CEO, TheUberCloud, Inc.,  
Los Altos, USA

Producing higher-quality products. Shortening time to market. Reducing product failure early in the design process. These are well-established needs in the manufacturing sector that can be addressed by making high-performance computing (HPC) simulation part of the early phase of a product life cycle. There are more than 300,000 small and medium-size manufacturing enterprises (SMEs) in the U.S. alone, and many are reliant upon desktop workstations for their routine CAE design and development work. According to the U.S. Council on Competitiveness [1,2], more than

half of these SMEs need more computing power.

Organizations looking to expand simulation capabilities increasingly investigate cloud-based simulation platforms as an attractive alternative to desktop or other in-house hardware solutions. For SMEs, the cloud can support simulation for both routine design needs and the occasional demands for

large model sizes or more extensive design exploration without having to make a large hardware infrastructure purchase. On-premise workstation or server hardware may not be suitable for future simulation demands, and can be costly to maintain and support when not fully used. Cloud-based hardware resources offer the benefit of scaling an organization's simulation usage up or down as needed. For a product designer, more computing power available on demand translates into more product variations analyzed and more parametric studies completed in less time, which increases product quality and accelerates time to market.

### HPC Cloud Experiment

The UberCloud online community and marketplace was created as an initiative to understand and overcome cloud computing roadblocks using a crowd-sourcing approach. The UberCloud HPC Experiment began in 2012, sponsored by ANSYS, Intel, Hewlett-Packard Enterprise and Microsoft Azure. Its purpose is to foster collaboration among engineers, HPC experts, independent software vendors (ISVs) and cloud service providers so that they can address cloud-based simulation challenges at scale, and to promote the wider adoption of digital manufacturing to SMEs. Since its inception, the HPC Experiment has drawn more than 200 engineering teams, each consisting of an industry end-user, a simulation software provider and a cloud provider. For SMEs, cloud computing is a key enabler of upfront simulation, which can reduce time to market, decrease costs and expand product innovation.

To this end, UberCloud developed HPC software containers that package the desired simulation tools along with the utilities needed to easily complete the engineer's analysis on cloud hardware. The containers abstract tasks such as partitioning, security, backup and data visualization into a browser-like experience, very similar to the engineer's workstation. The ANSYS software is pre-installed in the container, and configured and tested to give similar performance whether it is running on dedicated in-house hardware or hardware in a remote data center.

Working on the end-user's application, each team defines the requirements, implements the application using HPC in the cloud, runs and monitors the simulation jobs, views the results remotely, and transfers the simulation data back to the end-user. Each team then summarizes their results, experience and key findings in a case study, including studies of different mesh densities and numbers of CPU cores. Among the 18 case studies highlighted using simulation software from ANSYS [3] were analyses of a medical inhaler and two-phase flow in an energy plant. These and other examples demonstrate a wide range of applied CAE work being carried out in the cloud today by SMEs that can benefit from what Intel calls the "democratization of high-performance computing."<sup>▲</sup>



**ANSYS Cloud Hosting Partners**  
[ansys.com/cloud-partners](https://www.ansys.com/cloud-partners)

### ENERGY PLANT GAS ENTRAPMENT

Chiyoda Corporation, a leading Japanese engineering company, relies on ANSYS Fluent to tackle a variety of engineering challenges for clients in the global energy business. Chiyoda was challenged to complete very large simulations within short time frames to meet customer needs. With an overtaxed IT infrastructure, the company required a flexible approach that would provide extra computing capacity on an ongoing basis. For example, engineers needed to simulate gas entrapment in an energy plant with a two-phase gas-liquid flow application using ANSYS Fluent. Chiyoda partnered with Fujitsu Ltd. and the UberCloud collaboration platform to maximize its ANSYS HPC Pack licenses and leverage additional computing capacity. Today, by using 32 parallel cores via Fujitsu's Technical Computing Cloud, processing speeds are two times faster than if simulations were run in Chiyoda's own IT environment.

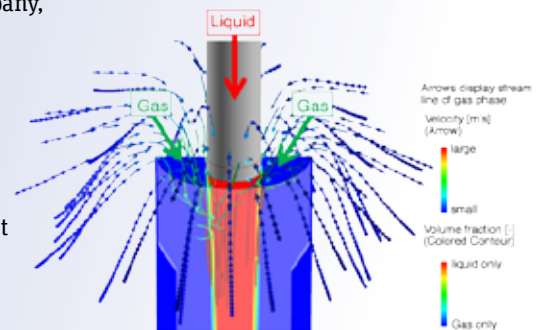

<sup>▲</sup> Flow path and volume fraction of liquid and gas for a gas-entrapment application  
*Image courtesy Chiyoda*



**Cloud Computing Best Practices for Engineering Simulation**  
[ansys.com/cloud-best-practices](https://www.ansys.com/cloud-best-practices)



## INHALER SPRAY MODELING

Pressurized meter dosage inhalers (PMDIs) are widely used to deliver aerosolized medications to the lungs, most often to treat symptoms of asthma or other chronic respiratory diseases. In the medical device industry, simulation is increasingly used to predict the flow and deposition of spray particles both inside the respiratory tract and also in the PMDIs and add-on devices. Such simulations require detailed information about the spray as it originates from the PMDI nozzle to ensure the validity of the downstream results.

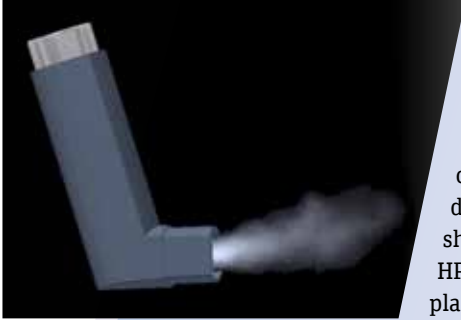

The objective of UberCloud Team 184's project, led by independent consultant Praveen Bath, was to characterize the fluid particles dispensed by a PMDI, in which the spray typically forms into a cone shape. The team used ANSYS Workbench with ANSYS CFX in an UberCloud HPC Container, which was integrated with the Microsoft Azure cloud platform [4], to evaluate the predictions of spray emitting from the nozzle and through a cylindrical domain of air at standard atmospheric pressure.

By creating five different volume meshes with increasingly finer resolution, the engineers performed a mesh refinement study and then benchmarked the solver's HPC performance on multiple CPU cores.

Although there was a learning curve for using the overall cloud platform and its features, the UberCloud HPC container made the process of model creation using Workbench and CFX much easier by drastically reducing the time for mesh generation, solver processing and post-processing the results for remote viewing. Altogether, the engineers invested about 10 hours to create the models and used the equivalent of about 500 CPU core hours to generate solutions. With the benefit of HPC, the finest mesh (1.2 million cells) was solved in about five minutes on eight CPU cores. The UberCloud container's auto-update email module enabled continuous monitoring of simulation jobs without requiring the engineers to log in to the server to check the status. Such container features helped the team with smoother execution of the project by facilitating user-friendly access to cloud server resources for an application with complex physics.

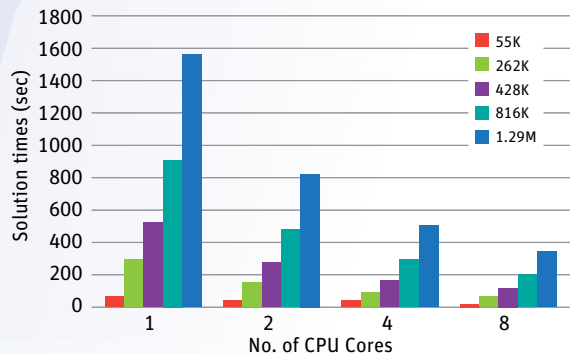

▲ Solution time comparison for different mesh densities running on different CPU core configurations

## ANSYS CLOUD-PARTNER SOLUTIONS

ANSYS participated in the UberCloud HPC Experiment so that our customers can explore the end-to-end process of partner-enabled cloud solutions for their simulation workload.

This has also helped us to develop cloud-computing best practices as well as to build out our cloud-partner ecosystem, providing customers with a choice of cloud computing solutions that best meet their needs. UberCloud is now one of our cloud-hosting partners.

– Wim Slagter,  
Director, HPC & Cloud Alliances



### References:

- [1] Reveal: Council on Competitiveness and USC-ISI Broad Study of Desktop Technical Computing End Users and HPC. [compete.org/reports/all/420-reveal](http://compete.org/reports/all/420-reveal)
- [2] Reflect: Council on Competitiveness and USC-ISI In-Depth Study of Technical Computing End Users and HPC. [compete.org/reports/all/421-reflect](http://compete.org/reports/all/421-reflect)
- [3] UberCloud and ANSYS. [theubercloud.com/ANSYS](http://theubercloud.com/ANSYS)
- [4] ANSYS 17.2 Fluids and Structures: UberCloud. [azuremarketplace.microsoft.com/en-us/marketplace/apps/ubercloud.ansys-17-2-fluids-structures](http://azuremarketplace.microsoft.com/en-us/marketplace/apps/ubercloud.ansys-17-2-fluids-structures)

# Simulation in the News

## ANSYS: THE CHEMICAL SIMULATION PIONEERS

CIO Review, May 2017

Simulation is a vital tool in the chemical and process industries. ANSYS continues to add the modeling capabilities that these industries require. ANSYS CEO Ajei Gopal explains the value of simulation in a sector where high raw material costs, overcapacity and demanding regulatory requirements have been a challenge.

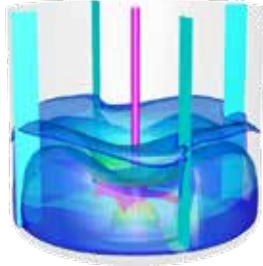

.....

## PRATT & WHITNEY STANDARDIZES ON ANSYS ENGINEERING SIMULATION

MCADcafé, May 2017

The new agreement will increase collaboration across Pratt & Whitney's global teams to help the company more efficiently solve some of its most complex engineering challenges. This will, in turn, enable the company to reduce expensive physical testing and accelerate product development.

.....

## ORCHESTRATING HPC ENGINEERING IN THE CLOUD

The Next Platform, February 2017

Through the ANSYS Enterprise Cloud, companies can begin to migrate some of their workloads to the cloud. Through collaboration with AWS and Cycle Computing, companies are able to leverage the cloud to ensure availability of computing power and maintain security while managing workloads.

.....

## YOUR BODY MODELED IN A COMPUTER?

Biovox, March 2017

Creating a virtual human will be essential in the future for healthcare and medical device companies to cost-effectively and systematically test new products early in the design process. The implications go far beyond medical-based industries and can extend into automotive and other industries where it is essential to determine how the human body interacts with a product.



## ANSYS 18.1 INCLUDES FEATURES TO SIMULATE MORE AND FASTER

Digital Engineering, May 2017

Engineers can create next-generation products quicker and easier with the release of ANSYS 18.1. ANSYS continues to build upon the digital exploration and digital prototyping capabilities released in ANSYS 18, enabling organizations to simulate more upfront, limit costly late-stage design changes, and bring their innovative products to market faster and easier.

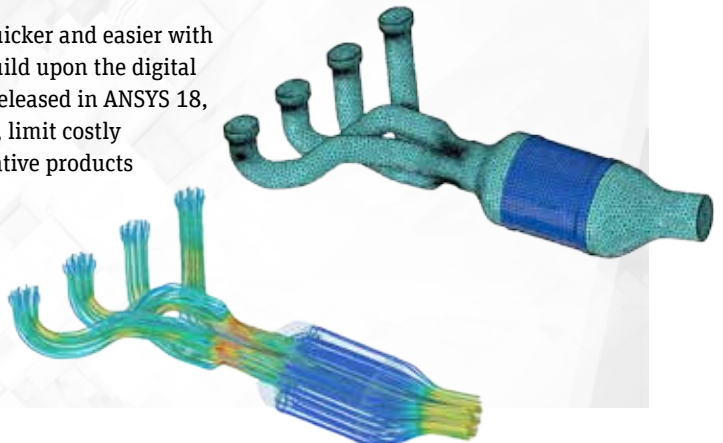

Release Highlights  
[ansys.com/18](http://ansys.com/18)

## FLYING HIGH WITH ANSYS: ANSYS ACHIEVES AEROSPACE MILESTONE

Bloomberg, April 2017

Manufacturers must meet performance targets and comply with industry regulations to ensure that critical equipment meets safety standards. Companies use ANSYS qualified solutions for embedded software to design, simulate, generate and test embedded code for more than 100 aerospace applications that have been certified under DO-178B and DO-178C.



## APOLLO ENGINEERING TAKES AMUSEMENT PARK CAD FOR A RIDE IN THE CLOUD

Engineering.com, March 2017

When engineering designs for amusement park rides, safety and reliability are paramount. Apollo Engineering Design Group uses structural analysis for stress and deflection, and to determine joint interaction, clearance and tolerances for roller coasters.



.....

## KEEPING THE WHOLE PACKAGE COOL

Semiconductor Engineering, May 2017

As system-in-package devices become more complex when manufacturers squeeze more transistors into less overall space, new heat dissipation issues are emerging. More heat is generated by a device as the number of transistors inevitably increase, but the ability to dissipate the heat depends on the package surface area.

.....

## METAL ADDITIVE MANUFACTURING KEEPS LEGEND FLYING

Engineering.com, April 2017

ANSYS Elite Channel Partner Phoenix Analysis and Design Technologies aided the owner of a vintage long-range escort fighter that was flown in WWII to create an improved replacement part. Using 3-D scanning and rendering, engineering simulation and additive manufacturing (3-D printing) from Concept Laser Inc., the team designed, manufactured and validated (and even reduced the number of components) for a replacement exhaust stack for the aircraft.

## FROOME'S "SUPER TUCK" ACTUALLY ISN'T FASTER

Velonews, May 2017

Researchers from Eindhoven University of Technology, Leuven University, the University of Liège, and ANSYS studied downhill positions of racing cyclists using wind tunnel testing and CFD to determine the most effective positions.

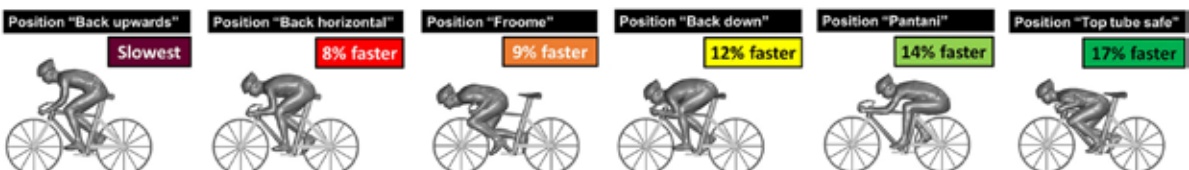

ANSYS, Inc.  
Southpointe  
2600 ANSYS Drive  
Canonsburg, PA U.S.A. 15317

Send address corrections to  
[AdvantageAddressChange@ansys.com](mailto:AdvantageAddressChange@ansys.com)



# Pervasive Engineering Simulation™



Product development is transforming. Engineering simulation is changing with it. With ANSYS, simulation expands across the product development process – from early exploration to digital prototyping to operations.

To learn more, visit [ansys.com/pervasive](https://www.ansys.com/pervasive)